

U A U C U



Student Research Exchange *Collected Papers* 2023



University of Aruba

UCU

UCU

MEMORANDUM OF UNDERSTANDING
BETWEEN
UNIVERSITEIT VAN ARUBA (U.A.) ORANJESTAD, ARUBA
AND
UNIVERSITY COLLEGE UTRECHT (UCU), UTRECHT UNIVERSITY, THE
NETHERLANDS
AGREEMENT

THIS AGREEMENT is made, and entered into as of the 26th of February 2013 by and between University College Utrecht and University of Aruba, hereinafter designated as UCU, and UNIVERSITEIT VAN ARUBA, hereinafter designated as U.A.

In view of their similar dedication to excellence in teaching, research and cultural exchange, the two institutions hereby agree to this Memorandum of Understanding with the objective of promoting exchange among their students.

BIJZONDERHEDEN

1. Each academic year during the term of this Memorandum of Understanding, up to two full year students enrolled at University of Aruba participating in the study program will be counted as one half (0.5) FTE. The enrollment of students from University of Aruba in the fall term, of each institution's academic year, will be selected on the basis of the agreed upon exchange ratio, averaging over a five-year period.
2. Six to eight UCU students and six to eight U.A. students, and faculty members of both institutions, participate annually in a joint undergraduate research program. The amount of research phase takes place at the University of Aruba. Details about this joint undergraduate research program are included in an appendix to this MoU.
3. Participating students will be nominated by their home institutions based on the following criteria: (a) Academic excellence as reflected in their academic records.



**Funded by
the European Union**

This publication was produced with the financial support of the European Union. Its contents are the sole responsibility of the authors and do not necessarily reflect the views of the European Union.

UAUCU
Student Research Exchange
Collected Papers 2023



UAUCU

Student Research Exchange

Collected Papers 2023

Compiled and advised by Eric Mijts, Jocelyn Ballantyne & Carlos Rodriguez

Myrthe Knip

Robin Prast

Thijn Fruijtier

İmre İşmen

Jasmine Coelho

Elizabeth van Hofwegen

Alexandra Ulacio

Eleomar R.C. Mateo

Noemi Pérez Kluin

Hanna Siwek

Jill van Bekhoven

Steff van den Berg

Julia Strijbosch

Zaïda Floren

Introduction to the eighth edition of the UAUCU Student Research Exchange Collected Papers

This volume includes research reports and personal reflections written by the 2023 participants of the UAUCU student research exchange program. This year's student-researchers are 14 students from the University of Aruba and Utrecht University, three from UA's Sustainable Islands Solutions through STEM (SISSTEM) program and 11 from bachelor programs of Utrecht University. They have been working on research in and about Aruba, and supporting each other in that process. Their texts reflect the fundamental aims that the program has had since its inception in 2015: to challenge students to engage actively not only with the content of research, but with each other and the world at large. These challenges, and the rewards of meeting them, are reflected in the personal reflections that contributors to this volume have written as a preface to the summary of their own research.

As in previous editions, the topics of the students' research are wide-ranging, drawing on the diverse backgrounds of their study programs, and yet all related to the sustainable development goals (SDGs) of the United Nations 2030 agenda. The works included here treat, for example, issues of sustainability in education and language, migration, waste management, soil quality, visual arts and cultural celebration, sustainable tourism, the built environment, food security, and humanitarian interventions. The type of research ranges from biochemical studies to studies on technology and engineering, anthropology, linguistics and sociology. We think that the papers also show how participation in a diverse team influenced the authors' approach to their work. The students provided each other with feedback on approaches to their research, and on the content, style, language and structure of their papers. The papers appear as submitted by the authors, including the occasional raw opinion or as yet underdeveloped conclusion. Some of the contributions

reflect completed studies, some of the contributions are preparatory explorations. Most of the student-researchers are still working on interpretation and presentation of their findings and will finalize these soon in bachelor theses and reports based on the results of the projects presented here.

As in 2022, the students from Utrecht prepared for their time in Aruba in November and December in a preparatory module (Community-engaged research in the Caribbean), and joined the UA students in a bachelor course at SISSTEM (Interdisciplinary and multidisciplinary approaches to sustainable development in small island states). Together in a classroom at UA, they defined their guiding principles and goals for their participation. These ideas reflect their hopes of working in ways that could be meaningful to others as well as to themselves.

A range of people have also made crucial contributions to the students' success, as in previous years. We, and our students, appreciate the importance and power of their input to this project as a whole. Among those, we especially want to thank UA's Carlos Rodriguez-Iglesias and Tobia de Scisciolo for their help in proofreading the papers in preparing them for publication here and for fostering the collaboration between the UAUCU students and the Academic Foundation Year students in the Research Aruba Program. There are, in addition, many others who have had roles as guides, lecturers, mentors, advisors, facilitators, respondents, interview participants, and engaged citizens, thank you! We hope that you have anticipated the work presented in this volume as eagerly as we.

Eric Mijts & Jocelyn Ballantyne
Project coordinators UAUCU

Guiding Principles

Respect

Be transparent.

Value and acknowledge local knowledge.

Communicate about how data will be used.

Be open about academic knowledge and any gaps or limitations.

Be scrupulous.

Pay attention to details.

Tell the truth.

Take responsibility.

Store data securely.

Get informed consent & respect privacy.

Be inclusive.

Make effort to include perspective of all relevant community members.

Show up for others.

Communicate in inclusive ways.

Listen to people with different perspectives

Goals

Learn from others and help others learn.

Become better at research.

Maintain a healthy work-life balance.



Follow this QR code to surf to some images and the posters presented at the 2023 UAUCU symposium at the University of Aruba.

Myrthe Knip	17
Small in size, big in culture Exploring cultural celebration and preservation as a tool for strengthening community culture against the dominance of tourism	
Robin Prast	37
Bettering San Nicolas: the communal transformative capacity of church-based humanitarian interventionism	
Thijn Fruijtier	49
A switch from Dutch to Papiamentu The Aruban debate on the possible switch to Papiamentu as the instruction language within the Aruban education system	
İmre İşmen	67
Through Relation; Sense of Belonging for Young Migrants in Aruba	
Jasmine Coelho	81
<i>Framing culture</i> : exploring the perceptions of the Aruban cultural identity and the role of murals in representing it	

Elizabeth van Hofwegen Vegetation as Insulation	103
Alexandra Ulacio Sorting Waste In A Smart Way: Conceptual Design of Small-Scale Smart Bins for The Improvement of Waste Sorting in SIS	119
Eleomar R.C. Mateo Small Island, Big Challenge A Reflection on food security in ‘Small Island State’ with Aruba as case study	139
Noemi Pérez Kluin Behavioural Interventions in Hotels in Aruba Can social norms encourage towel reuse and the use of refillable water canteens?	149
Hanna Siwek The Double-edged Sword – Benzene Degrading Bacteria in the Parkietenbos Landfill	165

Jill van Bekhoven
Steff van den Berg
Julia Strijbosch
Zaïda Floren

181

Quantitative and Qualitative data on agricultural fields in Aruba
An interdisciplinary paper analyzing Aruba's agricultural soil quality
and the relationships between local farmers and Santa Rosa



Myrthe Knip, University College Utrecht

Visiting Carnival parades was an important part of my study.

‘Are you even going to work on that research of yours? I only get videos of Carnival parades from you.’ One of my friends back home in the Netherlands texted me this during my stay in Aruba. I could gladly answer them that they would not have to worry about me not spending time on the research project. Because guess what: visiting Carnival parades was an important part of my study.

My experience in Aruba was special and exciting in so many ways. It was my first time studying abroad and I had no idea beforehand what to expect. It really felt like a leap of faith. It was also the first time going abroad kind of on my own, however: with a group of such sweet and fun people I could never feel alone.

Although everything ended up working out so well, this program was also a huge step out of my comfort zone on several occasions. As a language and culture student, participating

in a program that revolves around sustainability taught me a lot that I didn’t know before, especially about climate change. It’s a topic I was always concerned with, but seeing so many places and people affected directly by the consequences was still shocking. It has broadened my perspective and made me much more aware of the consequences of what we do with our world.

Another step out of my comfort zone, was doing interviews for my research. I remember struggling to find people who wanted to participate in my study. Not knowing that emailing is not really the way to go in Aruba, I felt very disappointed at all the unresponded emails. However, the moment that I randomly decided to walk into this cool-looking gallery in San Nicolas (that was ARTISA gallery) to ask for an interview, that’s when it all started to evolve. ‘Yes of course, do you want to do it right now?’ was the response. My Dutch, very plan-oriented brain was not prepared to do it on the spot, but even

that was not a problem. We planned the interview a week later and it turned out to be a beautiful conversation. And this was followed by all kinds of other inspiring interviews with people I greatly admire. I was deeply impressed by the passion and love people have for Aruba and the preservation of culture. I am incredibly thankful for their openness to sharing their feelings and opinions with me and for trusting me in processing this in a paper and documentary.

Something that I found difficult, also during the interviews, is that I as an 'outsider' come to investigate a culture that I am not part of. Culture consists partly of a number of practices that are clearly identifiable, but I think that it is also largely based on a certain 'spirit' or feeling. I didn't know to what extent I could understand or describe that as a Dutch person who has only been in Aruba for three months. I struggled with that sometimes while writing. I've solved this I think by sticking close to the opinions of the people I've interviewed. And that's the beauty of community-engaged research: it gave me the opportunity to recognize the local knowledge that the whole research revolved around.

As it turns out: stepping out of your comfort zone is fun. It teaches you a lot more about your environment as well as about yourself. And against my expectations: doing things that are tense actually brings you peace. And let's be honest: how hard can research be when it consists of talking to the most amazing people, you occasionally sit typing your paper by the pool and you have an awesome roommate who brings you tea and cookies when you're stressing out.

Before I end my reflection, I would love to thank some people who supported me during this research. I am happy to have met Robin, who is such a hiking fan as I am and did little celebration dances when we reached a milestone. And my roommate Thijn, with who I had lots of fun evening talks and who was there to occasionally tell me "boeien" (the Dutch version of 'it all doesn't matter that much') when I was stressing out about something.

I am also very thankful for this whole group, who were always there to help each other out: whether it is listening to someone's struggles in research or lending salt.

And foremost: am incredibly grateful to my supervisors Eric, Jocelyn and Berteke for always being so supportive and motivating and for teaching me so much.

The decision to participate in this program is one of the best ones I ever made. It has been a wonderful experience that I will always keep close to heart.



Small in size, big in culture

Exploring cultural celebration and preservation as a tool for strengthening community culture against the dominance of tourism

Myrthe Knip



“Overbuilt, gaudy, fast losing its culture”¹ That’s how Aruba is being described in a rating on the integrity of islands by National Geographic. The ranking was done by 522 experts in sustainable tourism and destination stewardship. Although a minority of the experts called Aruba dynamic and interesting, most of them share the opinion that Aruba is a “vacation factory” due to its beautiful-looking and crowded beaches. The story seems to be that tourism is having a battle with localness on the island, and that tourism is on the winning hand. The last reflection cited in the ranking reads, “If thousands of tourists are going to be dumped on a Caribbean island with little more than beach, shopping, and a casino in mind, I’d rather they stay on Aruba than on other more fragile islands.”² That sounds like the battle has already been lost.

Finding something one hundred percent authentic in Aruba can indeed be quite a quest. The view of most of the coastline is dominated by international mass-tourism hotels, the beaches’ white postcard-like sand was imported from Colombia, and the harbor - once the domain of local fishermen - is now filled with cruise ships and souvenir shops. Tourism is one of the biggest sources of income in Aruba and is therefore crucial in determining the islands’ prosperity.³ It seems to pose a threat to culture because of something that can be called the force of tourism. This phenomenon forces the cultural community to present their island in a certain way that is appealing to the tourists’ eye, to ‘sell’ it.

Despite these concerns, there is much to celebrate about Aruba's culture and people. The island is home to a rich and diverse community that values its history, traditions, and cultural celebrations. There is a complex balance to be seen here between the community's culture and the tourism industry on the island. This paper will focus on local culture in Aruba, investigating what it means to 'be Aruban'. Subsequently, the paper will also examine how precisely the power of culture could be used to strengthen resilience against the strong force of tourism. There is still much to celebrate and protect in Aruba's culture, something that could be used positively when it comes to tourism, in a way that the two strengthen each other. Therefore, the main research question is: *'What is the meaning of local community culture for Arubans and how can this be used to build resilience and sustainability against the dominance of tourism in Aruba?'*

Relevance

The relevance and motivation of this research emerge from an article by Robertico Croes et al. The focus groups they held in Aruba showed that especially young Arubans are frustrated about the impact tourism has on the cultural identity of the island.⁴ Thus, the concerns not only come from outside, like the National Geographic experts, but are also voiced on the island. A worrying discovery, since the building of a sustainable, healthy community is so important for several fields in society. The sustainability and health of communities is also crucial for the worldwide strive towards achieving the Sustainable Development Goals. Goal 11 is to create sustainable cities and communities, something that the protection of culture and cultural heritage can provide for.⁵ But challenges in the area of culture are also intertwined with other sustainability challenges. A strong, celebrated culture can make communities more connected and more resilient, making it a determining factor in the ability to achieve the SDG agenda.

The role of culture in this is often overlooked, especially in the academic world. This paper will draw attention to the importance of culture in building a sustainable community. The aim is not to criticize tourism on the island of Aruba, but to contribute to strengthening the resilience of local culture against the dominance of tourism, ultimately working towards a state wherein the two go hand in hand. Hopefully, this will give an opportunity for Arubans to spread awareness about their culture and what they find important about it. Ultimately, this paper forms an inspirational collection of stories and theories that teach us about the importance and potential of culture in a small island state.

Methods

A community-based approach will be used in this study. This approach is a collaboration between the researcher and the local community of Aruba. Also, value is assigned to local sources and people, with the goal of taking social action for social justice.⁶

The method, therefore, is twofold. Firstly, I executed a total of eight semi-structured interviews with people who live in Aruba, taking on a narrative approach. The people interviewed had various migration backgrounds, came from different hometowns and had different occupations. Six of the participants are one way or another directly active in the preservation of Aruba's community culture. Two of them work in small-scale tourist accommodations on the island and try to integrate tourism and local culture into their work. The interviews lasted between fifteen minutes to one hour. Partly, they consisted of prepared questions, as well as being guided by whatever came up in the conversation. The prepared questions differed per person, depending on their relationship with Aruba, tourism and preservation of culture.

In order to understand the personal experiences of the participants within the wider framework of tourism and culture in Aruba, as well as that of communities and cultural

memory in general, literature study serves as a cadre. These studies were partly retrieved from the Aruban National Archives and Biblioteca Nacional of Aruba and partly from online databases. I also participated in a few local and touristic cultural activities, taking on an ethnographic approach. Those activities were a total of four Carnival parades and the Bon Bini Festival at Fort Zoutman.

I also want to give some special attention here to Ana and Wenny, two Academic Foundation Year (AFY) students who live in Aruba. AFY is a university preparation program at the University of Aruba. Ana and Wenny were eager to help me in my research by connecting me to people who would possibly be interested in doing interviews with me, helping me look for literary resources, and coming with me to interviews.

Theoretical framework

Let's take a look at the most relevant concepts, clarifying the field to which this research belongs.

Anthropologist Sharon Macdonald writes in her book *Memorylands* critically about the way historical and cultural remembering is often organized in Europe. She uses the concept *European memory complex* to indicate the obsession Europeans seem to have with the memorization of their own history and filling landscapes with heritage of this history.⁷ The memory culture, the way in which historical memory is organized, is very material-focused in Europe. Land- and city-scapes are filled with memorial sites, museums, historical artworks and plaques to 'remind us of histories that might otherwise be lost'.⁸ Macdonald does not address colonialism in this context, so the consequences for memory-cultures in places that once fell under European power are not exactly represented in her research. It might, however, have been an influence on the shaping of remembrance in Aruba, which was part of the Dutch Kingdom up until 1986 without an autonomous status. MacDonal's conceptualization of the European Memory complex provides an opportunity to

look critically at this. It determines what is seen as 'normal memory culture' in Europe. The realization that memory can go beyond this European way of thinking about it in countless ways is needed for me as a Dutch (and thus European) student to investigate the way Arubans organize their historical memory with an open look and understand it fully to its right.

Anthropologist Artwell Cain introduces us to relevant questions in the context of national identity in Aruba.⁹ He asks among other things who determines which person is an Aruban, and who is not. Additionally, he asks questions whether it is reasonable to say that many persons in a community are caught up in an identity crisis. These are questions about belonging. A relevant concept here, first introduced by David McMillan and David Chavis, is *sense of belonging*.¹⁰ Cain defines it as: 'the feeling of well-being and at the same time the feeling of being at home and self-categorization'.¹¹

McMillan separates four factors that form a sense of community.¹² These factors consist of a *spirit* of belonging together, a feeling of *trust* and safety, forms of *trade* where they can benefit from being together and a connection to time and space via *art*.¹³ A more singular definition is offered by Catherine Good et al., as: 'one's personal belief that one is an accepted member of a community whose presence and contributions are valued'.¹⁴ This last definition is quite similar to the one by Cain, and this is the one that will mainly be used in this study. The four factors by McMillan, however, serve as a way to look deeper into what exactly forms a sense of belonging and community in Aruba.

Structure

The paper is divided into five parts:

1. Where it all started - on the history of the island and how the current relationship arose
2. On the meaning of being Aruban - an exploration of

what being Aruban means to people and how Aruban culture is expressed

3. The benefits of tourism for Aruba
4. The tourism threat - how tourism endangers authentic culture in Aruba
5. Towards a healthy balance - thinking about possibilities in creating a healthy balance

The study will be closed of with a conclusion on the importance of community culture in Aruba and how that can be used as a tool to create a healthy balance with tourism.

1. Where it all started

The first inhabitants and colonialism

Aruba contains a diversity in people, culture and origins that has its roots in several historical periods. We start this historical travel in approximately 2500 B.C. The first residents of Aruba were Indian populations who lived as hunter-gatherers.¹⁵ Around 850 B.C, Caquetio Indians from western Venezuela migrated to Aruba and introduced pottery and agriculture.¹⁶ People lived from local Aruban products such as corn, cassava and fish.¹⁷

The first Europeans to arrive in Aruba were the Spanish in 1499, who also introduced Catholicism on the island. Since the Leeward islands did not possess the precious metals they hoped for, they declared them as "islas inútiles" which means "useless islands".¹⁸ The Spanish then attached little value to the islands, which resulted in the Indian cultures being damaged or destroyed.¹⁹

A second raid was done by the Dutch West India Company, who took possession of Aruba in 1636. Curacao was exploited as a slave center by the Dutch, and Aruba served as a distribution for Curacao due to the many goats and horses on the island.²⁰ The Indians were used to capture these horses. Although it was on a smaller scale than in Curacao, slavery also took place on Aruba.²¹

The Lago refinery

In the 1920s, the oil industry arrived in Aruba, which fastened modernization processes and brought immigrants from Europe, North and South America and China to the island, making Aruba a truly pluralistic society.²² The Lago oil refinery settled in San Nicolas. Papiamento, the mother language of many Arubans, was turned down as the official business language because it was not seen as a full-fledged language.²³ English was used but this caused major communication problems for Arubans, and the island did in general not have enough workers to satisfy the demands of the refinery. As a result of this, the staff was supplemented with foreign workers.²⁴ Much of this immigrant labour came from other Caribbean islands. This caused for another migration flow to Aruba.

Rise of tourism

In 1985, however, the Lago refinery closed down, signifying the end of a profitable industry.²⁵ This is where the tourism industry took over. Tourism already existed on a considerable scale in Aruba.²⁶ The development of tourism on the island had started quite small in the 1950s, as a very conscious choice.²⁷ Aruba seemed to lend itself well to that, given the beautiful beaches and warm weather.²⁸ Soon after, an ambitious switch to luxury tourism took place, welcoming cruise ships and luxury hotels.²⁹ The closure of the refinery required a quick switch to tourism as the main profit industry.³⁰ Since Aruba was already used to large-scale thinking and marketing, knowledge only had to be transferred to another industry. A great expansion program was set up to provide for national income and employment. And so, the number of hotels doubled during the 1980s, infrastructure was put in place and social facilities were expanded.³¹ That's how Aruba slowly started adapting to the wishes of the tourism industry.

Cultural identity formation

Culture has always been interwoven through these historical events. The influence of political happenings on questions

about Aruban culture and identity becomes clear from an edition of the magazine 'Schakels' ('Links') from 1970. It is explained how the Dutch Antilles became independent and could pursue their own interests, also regarding contact with foreign countries.³² The authors see this as the first straight-up confrontation for the Antilles regarding the question: 'Who am I?' However, Antillian's pride and feelings of unity have been there since the 17th century, the authors state. The sense of unity was shared with the newcomers.³³

The separate identities of the islands do not seem to be a relevant topic for these authors in the 1970s. This likely has everything to do with the time context, since Aruba did not receive a separate status from the other islands until 1986. It is a relevant thing to keep in mind when we start thinking and talking about the ways Arubans shape their cultural parts of life. The possibility of thinking about Aruban identity separately may still be quite new, given the course of history. Arubans might be fully within shifting identity-making processes. This comes with the difficult task of giving shape to their meaning of 'being Aruban' within a society where tourism is economically and presentationally the priority.

2. On the meaning of being Aruban

This chapter forms a collection of stories of people involved in Aruban culture, on what Aruban culture is, what being Aruban is, how it presents itself and how it should be preserved. This offers the potential to explore possibilities for local culture as a tool for cohesion and will show which parts of the Aruban culture connect and bring people together.

Sense of belonging in a culturally mixed society

The political and migrational history of Aruba brings people from several geographical backgrounds together on the island, making Aruba a cultural mix. Therefore, the meaning of 'being Aruban' can be a complicated thing. Especially in

societies that warrant people from many different cultural backgrounds, a common sense of belonging is essential for a community's unity and stability.³⁴

I sit opposite to Yahaira on the couch in her atelier, surrounded by pots of paint and some of her colorful, abstract artworks. We met earlier at ARTISA gallery, where her art is exposed. She kindly invited me to her home, where we talk among other things about the influence of multiculturalism on the understanding of belonging. When I ask her about the meaning of being Aruban, this influence becomes clear. 'I can say "I am Aruban" because I am born here'³⁵ she says, but she also immediately explains that her roots are Colombian. Her grandmother migrated to Aruba, which makes her the third generation of her family living on the island. She explains that this is the kind of situation many people who live in Aruba find themselves in.³⁶

Aruban community culture

What is it, then, that people living in Aruba share with each other? A slight smile comes to Yahaira's face when she tells me that Arubans love to party, eat good food, and be exuberant. Life in Aruba also mostly takes place outdoors, according to Yahaira. There seems to be a strong connection between Arubans and their island, and they love to spend time enjoying nature.³⁷ Moreover, Arubans often hold on to their family's origin identity.³⁸ On the one hand, this might strengthen cultural differences, but on the other hand, attaching value to your roots and family is therefore also something that Arubans share with each other. The embracement of multiculturalism seems to be rather a unifying factor than something that drifts people apart.³⁹

'Super proud', Jeanèdy answers when I ask her if she is proud to be an Aruban. 'I would not have it any other way.'⁴⁰ Jeanèdy Semeleer is the manager of ARTISA gallery and also an artist herself. The works they show are made by local artists and it also is an open space for art-related activities. Not only does she passionately work in sharing

and preserving Aruban art, but when she talks about her own Aruban identity it also becomes clear how much being Aruban means to her. A beautiful, almost emotional moment, happened when I asked her about that. ‘I never had anyone ask me this question before’, she says before taking a pause to think about her answer. Then she starts: ‘Being an Aruban means being kind, being helpful [...]. Being aware of where we’re from, and being aware of who we are. And living our truth as Arubans every day.’⁴¹ She recognizes that culture is constantly changing and evolving, which is a normal and healthy process. However, who the community members are as Arubans, is something that she believes should always remain core.⁴²

Someone else who is passionate about the preservation of Aruban identity through art is Anthony Croes. He gave me a tour of Etnia Nativa, his art gallery and museum, showing me his way of cultural preservation. He is passionate about Aruba’s Stone Age and native people, and his artworks are inspired by this.⁴³ His work has close ties to his own beliefs on what being Aruban means. In his opinion, to be Aruban you need to have roots with the island, meaning to him the people whose families were there before the Lago came.⁴⁴ The connection with his past ancestors is very valuable for him personally. This is visible in his artworks: he incorporates materials the Ancient Indians on the island used in his art, as a result of which the past and present collide.

Renwick Heronimo, the curator of the Aruban Museum Foundation, believes that culture in Aruba is strongly about lived practices, traditions, and customs.⁴⁵ He also mentions music and Papiamentu as important pillars, since those are things that connect Arubans, shape identity, and warrant stories that are typical of Aruba.⁴⁶ When I ask him if it can be that culture in Aruba is mostly intangible, he agrees.

Intangible heritage

This concept of intangible heritage is deeply explained by Clifford Rósa, who has been the chairman of Rancho

Foundation for 13 years.⁴⁷ Rancho Foundation is centered in the Rancho neighborhood, which is close to the harbor and used to be a fishing district. Nowadays, the neighborhood struggles with crime and drug use. From the harbor, where wealth and luxury flow all over, it is less than a 10-minute walk to Rancho. A walk during which social differences become visible. Intangible heritage has a big role in Aruba, and especially in the Rancho neighborhood since society there highly revolves around practices, crafts, and skills. A rapid loss of fishing- and boat-building know-how is happening, since the stories and working methods of the old fishermen are seldom transmitted to the new generations.⁴⁸ Renwick also talks about the big influence the Covid-19 pandemic had on the loss of stories. Stories, especially the ones by elderly people, were told less since life took place less outside. This caused a lot of loneliness among elderly people.⁴⁹ These examples show the fragility of intangible heritage. The fragility of memories when they are not preserved in material objects is where in Europe the obsession with the objectification of culture and memory kicks in.⁵⁰ This is the concept of the European memory complex, which was introduced earlier. Europeans have a tendency to try to stop the process of forgetting history by filling landscapes with physical spaces for memory and preserving all physical remains of history.⁵¹ According to Renwick’s and Cliffords’ stories, the way of organizing history and culture in Aruba is somewhat the opposite. History seems to be more ‘lived’ in the present, by traditions, practices, and stories.

National festivals also have a special role in the preservation and celebration of culture in Aruba. An important day is national flag day, the celebration of Aruban identity on the 18th of March. On this day, cultural activities are organized all over the island, including dance and music, local markets, and people selling local food. The Aruban Carnival is also central to celebrating culture and identity. It really is a happening that brings people together. Yahaira also describes it as the moment when all the talent that is present in Aruba will assemble in dancing, singing, making

costumes and props and doing makeup.⁵² Arubans express themselves in this way. It is an amalgamation of everything Aruba wants to show of itself.

Expression through art

A special role in expressing and celebrating Aruban identity is reserved for art, or rather perhaps the spaces where art is shared. In Mcmillan's theory on sense of community, art is how feelings of belonging are connected to time and space and are preserved.⁵³ Someone who can tell us everything about that is Lotte van den Heuvel, the head of programming and education at Cas di Cultura. Located in Oranjestad, it is the only national theater in the whole Dutch Caribbean area, and they also organize cultural activities and rent rooms. Lotte is very heart-spoken about the importance of culture and art in a society like Aruba's. Having a space for expression makes people feel welcome, helps them develop talents, and generally brings them in touch with their Aruban identity.⁵⁴ 'I always joke, I call us the cultural Google of Aruba', she says laughing, because Cas di Cultura retains lots of knowledge about artists in Aruba in the present and past, and connects people to the information or art they are looking for.⁵⁵ It preserves this part of Aruban culture and makes it 'alive' by connecting present people with whatever kind of art and artist they are interested in. One compliment they received clearly shows the importance of this in sustaining Aruban identity: 'Someone said that they don't feel more Aruban anywhere else than at Cas di Cultura, so that just shows that this place is of immense value to this island'.⁵⁶ She explains that art sustains identities, but it can also expand identities. It takes you out of your comfort zone and helps you gain confidence and become who you are.⁵⁷

All these people share a wonderful passion: the preservation, the celebration, the exhibition of all that's important to the Aruban community. They all see the importance of culture for a community, so much so that they commit to its preservation. Some of these activities are even non-profit. The heritage Arubans preserve is primarily intangible,

which makes it vulnerable on the one hand, yet very alive and celebrated on the other.

3. The benefits of tourism for Aruba

Tourism in small (island) economies like Aruba is rapidly expanding due to two reasons. Firstly, the availability of low-cost long-haul flights is increasing, making it cheaper and more accessible for people to go to island destinations, even if that is not close to where they live.⁵⁸ Second, cruises are becoming more and more popular⁵⁹, making transport overseas easier and part of the entertainment. Aruba nowadays welcomes around 1 to 2 million tourists per year.⁶⁰ For comparison: this is ten times the size of Aruba's whole population. The number of tourists dropped significantly during the Covid-pandemic but grew back very quickly afterward.⁶¹

Economic impact

The presence of tourism has a positive impact on the island in some areas, especially economically. The reliance on tourism helped Aruba out of the economic crisis that the closing of the Lago Refinery caused.⁶² Currently, the most visible effect is the provision of employment. 80% of jobs in Aruba are related to tourism⁶³ Tourism also accounts for 68.9% of Aruba's total export.⁶⁴

These jobs often go to foreign employees, which makes the local value added to Aruba doubtful. However, this process is also proven to provide knowledge transfers to the island.⁶⁵ Tourism puts pressure on infrastructure and local sources to improve rapidly, forcing government efforts to enhance facilities.⁶⁶ Once this is done, not only tourists but also the local population can take advantage of this.

Emotional impact

The interviews I have done show that the welcoming of tourists in Aruba can be experienced as a great honor by the community. Jeanèdy for example, shares how she loves

to be in contact with tourist; she meets them often when they visit ARTISA gallery. She sees up close how tourists are interested in local Aruban art.⁶⁷ Yahaira as well feels honored and proud that tourists show interest in Aruba. Regarding tourists participating in Carnival, she says laughing: ‘amazing, if they can stand the sun, it’s amazing.’⁶⁸ There is even a sense of responsibility involved in this: she senses feelings of pride and contentment when tourists leave her island feeling happy.⁶⁹ Despite not working in the tourism industry, she wants to contribute to giving people a good time on the island.

Although the effects of tourism on the island are not just positive - which will be explained next - it is also experienced by part of the population as something valuable. Thereby, it is a source of employment and income that the Aruban economy heavily relies on, and that cannot simply be removed from Aruban life and society.

4. The tourism threat

Tourism, thus, forms a somewhat positive form of income and employment on the island. Thereby, some Arubans experience it as an honor that people pose interest to see and learn about their island. Why is it that Aruba still scored so low on National Geographic’s ‘integrity of place’-list? And what do the islanders think of this?

Tourism putting pressure on cultural practices

Clifford gives us a striking example of how tourism can really overtake things that are important to Arubans in practicing and preserving their culture. The harbor in Oranjestad is currently dominated by souvenir shops. There are about twenty of them. The products that are sold are mostly wooden signs, bracelets, and clothes. Aruba’s tourism marketing slogan, ‘One Happy Island’, can be seen everywhere. This harbor was once a local food market.⁷⁰ Jeanèdy still has a childhood memory of going to this market with her mother when she was a little kid.⁷¹

Clifford explains that because people can no longer go to this fruit market, a part of the culture has been lost.⁷² This effect is twofold. The market itself was a cultural place since it was something the community organized with each other, additionally forming a meeting place. But also the practice of ‘going to the market’ was part of the culture. By replacing a community-focused market with a tourist-focused shopping place, one of the community’s cultural practices is lost for the sake of tourism. Tourism thus puts pressure on intangible heritage. The souvenir shops do not display anything of Aruban local culture to tourists, since almost nothing was made by local artists, people who Clifford beautifully calls ‘cultuurmakers’ (culture makers).⁷³ Moreover, it is the first thing tourists see when they arrive on the island. This has everything to do with the presentation of Aruba to tourists; not firstly as an authentic place where actual people live, but as a paradise that lies at the feet of tourists.

Anthony compares tourism with water. ‘Tourism is water, but too much water kills the plant. [...] With too much water, all these cacti will die.’⁷⁴ He explains that tourists are welcome on the island, but they should keep within certain boundaries. Tourists who come out of interest to Aruba are a good kind of tourism. However, at the point where Arubans don’t like that anymore, tourism crosses a boundary, and at the moment tourism is oversaturated.⁷⁵

In fact, the full loss of culture is a very real possibility in Jeanèdy’s eyes. It seems to her that the community is losing touch with who they were, of their indigenous past roots.⁷⁶ Part of the reason that this happens can be that tourism is prioritized over local culture, which shows that culture is currently in a vulnerable position in Aruba.

The marketing paradise

Larissa, who works in the small-scale tourism industry, supports the notion that tourism is a threat to local culture. Although she strives to promote local activities and spots to

tourists, she notices a huge gap between the tourist industry and local culture in Aruba.⁷⁷ During the Covid-pandemic, she was confronted with the impact tourism has on the island and the insane priority that is given to it. During Covid, when tourism was less of a possibility and therefore less of a priority, she noticed that only then more activities were organized for the local people. There were local activities and restaurants that came with cheaper deals for local people, for example. However, when the first airplane arrived, all this was abolished.⁷⁹

Thereby, tourists are attracted to Aruba mostly because of the beach, and the cognizance of their impact as a tourist on nature and culture is very low.⁸⁰ According to Larissa, this is mostly due to ignorance. This ignorance has all to do with the marketing campaigns for tourism in Aruba.

Renwick explains this. Tourism is an impactful force in determining Aruba's identity and how it is presented to the outside world. It happens on the island on a large scale and is based on multimillion-dollar campaigns.⁸¹ Aruba is being 'sold' to tourists, and in order to achieve this, the island is marketed as the perfect tropical paradise.⁸² Where it really goes wrong, however, is that Aruba is not only sold as such, but the actual island has also been adapted to this mentality.⁸³ An example of this is the many palm trees that can be seen in Aruba, which are not natural to the island. They were purposefully planted in order to fulfill that perfect tropical paradise image. This is a general problem that also happens in other destinations; host societies often reshape their culture in a way that is attractive to tourists.⁸⁴ For the vacation-goers, their travel to Aruba is an escape from their own life, responsibilities, and the place they live in. Aruba might then feel for them as this paradise island away from home, that they are not responsible for. Some tourists use Aruba as a place to unwind and do whatever they want to get recharged, not thinking further about how they should treat the island, its people, and its culture. This also puts stress on the natural environment; the increase in infrastructure is at

the expense of natural areas, and aviation and cruise tours are highly polluting activities.⁸⁵

Part of this branding is also the 'One Happy Island'-concept. This marketing of 'happiness' is partly based on reality. The happiness factor seems to be high on the island, although this is tested in highly questionable ways according to Renwick.⁸⁶ Still, this emphasis on happiness is mainly used to serve this 'two-week perfect vacation'-mentality where people can leave their responsibilities behind.⁸⁷ It saddles the island with the pressure to live up to this slogan.

The choice of this slogan and the reason it works so well is linked to the type of tourism Aruba receives. Ineke Verberne notices that it is hard to draw attention to the existence of 'Elements of Aruba', the small-scale apartment complex she and her husband own.⁸⁸ This is because so much priority is given to the big multinational hotels in Google algorithms and by the tourism industry.⁸⁹ The popularity of large-scale and luxury tourism, is, according to her, due to the Americanism of tourism. Aruba is the vacation destination for a lot of Americans, who are mostly interested in those large hotels.⁹⁰ American people only have ten vacation days per year and generally a lot of money to spend in those few days, she explains. In those ten days, Americans seem to love to stay within their comfort zone: eating the foods they know, enjoying luxury and just moving between the beach and their hotel.⁹¹ There is a lot of money in that mass-industry, which makes it easier for the bigger hotels to promote themselves. There is a lot of pressure from society on the Aruba Tourism Authority to change this situation, but it takes a while.⁹² At this point, Ineke is concerned about the status of tourism in Aruba. It overpowers social problems, she says. The focus of Aruba seems to be so much on the outside, on making it right for tourists, and on the visual appearance of Aruba, to the point that Arubans themselves and the care for society are pushed to the background.⁹³

Tourism is thus in several ways prioritized over social and cultural matters. The main goal seems to be to present Aruba to the outside world as the ideal happy getaway from home, and not to present the island in its real cultural richness.

5. Towards a healthy balance

Tourism poses a threat to community culture in Aruba. However, it can be concluded that the island economically also heavily relies on tourism, so simply refusing the inflow of tourists is not an option. Chapter two of this paper showed us that being able to participate in community cultural activities means a lot to people, so letting this culture decay is not an option either. The only option seems to be to find a way in which both can co-exist, without tourism overpowering the community's culture. This chapter is focused on community-generated knowledge and reflections from the academic field on possible synergies.

Enhancing consciousness and knowledge of Aruban history

Several interviewees mentioned the importance of education in knowing and standing for who you are. Aruban history is something that Aruban kids barely get taught about in school. Jeanèdy tells me she has endlessly learned about the first and second World Wars, but her own history as an Aruban was something that was painfully missed in education.⁹⁴ This has to do with Dutch-Caribbean power relations: the Netherlands and Aruba share the same history education curriculum, forcing Aruban students to learn what the Dutch government sees as the important parts of history. This, again, is also related with the European memory complex. The European obsession with memory has important roots in hegemonic and postcolonial power relations. Heritage, and also other ways of preserving and sharing historical memory like history education, can lead to the materialization of memory as a property.⁹⁵ This forms the framework in which the Dutch impose their perception

of history on Aruban schools' curricula. Arubans are the victim of this by not receiving proper education on their own history. This cannot be changed easily, precisely because of these power relations. But to cite Jeanèdy: 'when a child knows who they are, that is something very powerful that they will keep for their life. You have to know who you were in order for you to know where you're going.'⁹⁶ Clifford also emphasized the importance of education. This is, according to him, an important way to help Arubans keep historical knowledge within the community, as well as to educate tourists about Aruba's heritage.⁹⁷ Enhancing education on Aruban history could thus work in both ways with the ultimate goal of strengthening consciousness and knowledge about Aruban identity against the force of tourism.

Tourism needing culture

Some interviewees also mentioned that tourism in Aruba needs the Aruban community in order to be successful. A culturally and socially healthy community is something that is also very important for tourism according to Jeanèdy, since the tourism industry is nothing without the community.⁹⁸ The community needs to be flourishing in order to welcome and provide for tourists. Therefore, Jeanèdy thinks the tourist industry should be more controlled and more based on what is good for the community. The government is so focused on building, that they forget about the local people.⁹⁹ She seems to see this rather as a problem of the government than of the tourists since the tourists just want to see the island and culture, something she appreciates deeply. The government is the one who holds the power, and should let tourism happen in a more controlled way.¹⁰⁰ This would avoid that the community is overwhelmed by an immense number of tourists, and the tourism industry would not exploit the community. In the second chapter, it was shown how several cultural preservation efforts are done to make this community culturally flourish, like sharing art and participating in festivals. These people's work is therefore extremely important in the healthy

balance between tourism and culture. The priority in tourism should lie in what is good for the community, and that should be the basis from which to work.

Renwick emphasizes the need to show the real Aruban culture to tourists and to use that in marketing as well; otherwise, the island would become some kind of 'fantasy island'.¹⁰¹ He sees a positive trend in the past decades, with tourists becoming increasingly interested in Aruba's cultural habits. Renwick states: 'It is important for tourists to give them a little bit of information of where they actually are, but also give them enough information so that they respect where they are as well. So they also realize in relation to heritage and in relation to nature, that it is vulnerable.'¹⁰² Since the stay in Aruba is for many vacationers an escape from their own life, they seem to have the tendency to treat the place where they are as a paradise-escape, forgetting that they enter an island that is still home to animals, plants, and people, and that preserves stories and cultures. So awareness is important. But tourism is improving in this respect, according to Renwick. Tourism is becoming more individual, which reduces interest in large hotels.¹⁰³ Marketing campaigns are decreasing as well.¹⁰⁴ Moreover, Aruba has a lot of frequently returning tourists, who express more interest in the community and their culture than first-time tourists do.¹⁰⁵ This seems to be a positive trend in the field of tourism, which is met by efforts from Arubans to share their culture and preserve it more. Thereby, culture is moving up the political agenda as it is important to tourism and can also be part of the tourist branding, which could be beneficial for all the non-profit cultural preservation organizations on the island.

For tourists as well, it is often a positive and educative experience to learn about the community. Cultural tourism experts Bob McKercher and Hilary du Cros state about intangible heritage tourism that 'it is an important tourism asset as it enables tourists to gain a deeper understanding of the destination they visited. It is manifested through

live performances, festivals, events, storytellers, and local markets. Indeed, tourists often talk about "absorbing" the local culture as their means of consumption.'¹⁰⁶ Since culture is changing, a question that can be brought up is whether it is beneficial for communities to preserve traditions and practices that might not be part of their contemporary culture anymore.¹⁰⁷ Anthropologist Mark Mansperger suggests that this is the case to a certain extent. Slowing cultural preservation may give people a chance to keep something of meaning within a rapidly changing world. Too rapid of a change in culture can lead to identity crises and feelings of meaninglessness.¹⁰⁸

However, this idea of tourism in Aruba needing culture is also a tricky thing, as we need to stay far away from the closely related idea of tourism profiting from culture. Aruba's community culture should not in any way be forced to be or be presented as a static or singular thin, when in fact it consists of multiple cultural habits and is constantly subject to change. Furthermore, the link between tourism and intangible heritage is a tenuous one, which means that the "culture" tourists consume is not always representative of authentic cultural heritage.¹⁰⁹ Efforts from the field of tourism as well as from Aruban heritage preservers should be made in order to keep the culture that is shared with tourists appropriate to the community, giving the community lots of agency in this.

Culture and society benefitting from tourism

Renwick stated that tourists should be made aware of where they are, so they realize the vulnerability of heritage and nature and treat it with respect.¹¹⁰ There are several ways to make tourists aware of this, in ways that also aim to benefit the community. One solution in this framework that Larissa comes up with is to stimulate more participation of tourists in 'Aruba DOET'.¹¹¹ Aruba DOET is a campaign by CEDE Aruba and the Oranje Fonds. During this event, voluntary work is done in several places on the island where it is needed. Larissa thinks that this event lends itself well to

the involvement of tourists to come in contact with local people.¹¹² It could provide a chance to learn about what is going on in Aruba, in which aspects help is needed, and to give something back in return for Arubans' hospitality. Although this could be a way to involve tourists with the community in a way that is actually helpful, the risk of this kind of 'humanitarian tourism' should be kept in mind. Volunteer tourism is 'a type of tourism where tourists pay to participate in development or conservation-oriented projects.'¹¹³ Participation in Aruba DOET would not fully meet these characteristics since it is only short-term voluntary action during a vacation that is not centered around voluntary work (in most cases). Tourists also do not pay to participate in Aruba DOET. However, it does comply with what human geographer Mary Mostafanezhad describes as the humanitarian gaze. This 'refashions contemporary humanitarianism as an empathetic gesture of commoditized concern.'¹¹⁴ She argues that it maintains and extends geopolitical discourses of North-South relations that naturalize inequality.¹¹⁵ It can thus strengthen hegemonic relations when the host country is placed in a dependent position on the tourist. This activity must therefore really be used in the service of the community and not as an emotional redemption for the tourists. Moreover, I think the request for help must come from Arubans; tourists should not decide for themselves where they are going to help.

Letting tourism provide a platform for culture, however, could also be a beneficial action. Antonia Besculides et al. state: 'The act of presenting one's culture to outsiders strengthens the idea of what it means to live within a community, thus increasing identity, pride, cohesion, and support.'¹¹⁶ They did a case study on Cajuns in Louisiana and found that tourism could allow them to become 'tourists' of their own culture since they presented parts of their culture to outsiders while learning about it themselves.¹¹⁷ Promoting your culture also creates a sense of pride and ensures its preservation.

In Aruba, an important place where both tourists and local Arubans learn about Aruban culture could be museums. Renwick sees these as one of the most important possible connection spaces for tourists and local Arubans.¹¹⁸ Both groups often visit museums. Tourists do because they are interested in Aruban culture, and Arubans do because they want to learn more about their own history and identity. Museums can be especially valuable to Arubans because information such as the history of the island and its people is rarely taught in schools, as Jeanèdy said.¹¹⁹ Museums can perhaps fill that missing part in identity formation a bit. Renwick explains how museums have several functions in Aruban society. They determine what becomes heritage and therefore what parts of history should be remembered or materially kept.¹²⁰ Therefore, they also are impactful in issues of value and passing on to the next generation.¹²¹ They are about the past as well as the future, and have a role in determining identity and the 'national story.'¹²² It is about how Arubans present themselves as well as how Aruba is presented to tourists, and meets in museums.

In Renwick's story, culture and tourism actually seem to need each other. Authentic culture is an effective form of marketing for the tourist sector, and more importantly, something that tourists are increasingly really interested in. The priority of the Aruban government lies on many things other than the preservation of local culture, because culture simply does not provide a lot of money and does not 'score' well. Especially on a small island, culture is not seen as essential. However, tourism is seen as essential, yet it cannot flourish without the well-being of the community and its culture. If tourism is a priority, local community and culture must by definition also be a priority. Culture could benefit this way from the 'booming business' of tourism. This only requires the tourism industry to realize that it needs the community. Then the cultural sector would no longer have to rely so heavily on non-profit organizations and the people who work so hard for preservation, often only motivated by passion and love for Aruba. Then the

calls for the preservation of Aruban culture would no longer only be coming from the community.

Conclusions

The research question of this study was: ‘what is the meaning of local community culture for Arubans and how can this be used to build resilience and sustainability against the dominance of tourism on Aruba?’

The current situation seems to be a wicked choice between community well-being and the tourism industry, Aruba’s chief economic pillar. However, seeing how people in Aruba engage passionately in the preservation of culture gives a hopeful perspective on the situation. Some interviewees mentioned that it is characteristic for culture to constantly be in motion. Culture changes and so does Aruban culture, and steadfastness is not something that should be held on tightly or that Arubans seem to want to hold on to too much.

Preserving memories in Aruba is also mainly focused on intangible forms of heritage. Culture and history are not prominent in material things, but it’s more ‘lived’, it’s celebrated. The intangibility of heritage and practices makes Aruba’s community culture vulnerable to change and external influences, but also very open and welcoming to new people and positive influences. It is open to multicultural influences, which gives an extra boost to the mobility of culture. That in itself is part of Aruban culture as well.

This brings up difficult questions for the tourism field. The effects of tourism on Aruba turned out to be twofold on the island: it has positive economic consequences and gives the Aruban people a sense of pride to know that tourists are interested in their island and culture. However, the perfect-paradise marketing also forces Arubans to live up to those expectations. In order to achieve this, social problems are pushed to the back and there is more focus on the presentation of the island than on the community.

Remarkable to me is the passion the people I spoke with have for the preservation of Aruban culture. Maybe that is also an important cultural pillar: a love for being part of Aruban culture and a general passion for preserving and celebrating it. People are so involved in Aruban culture that they even do work for which they receive no government funding. The things they want to preserve are among others art, festivals, history, the beauty of their island, and a general spirit that seems to live within the community of helping and caring for each other.

The synergies interviewees offered in making tourism and culture go hand in hand were to strengthen Aruban self-awareness with education, to promote awareness of the fact that tourism needs the Aruban community to be well and flourishing, and that tourists should learn more about the island through ethically correct organized volunteer projects, as well as through museums. Museums in general turned out to be an important possible meeting place for both Arubans and tourists to learn about the community culture’s history.

On the surface, Aruba might indeed look like a “vacation factory”, as the National Geographic experts said. However, beneath this, there is still a very rich culture and a strong passion to preserve it. The expert in National Geographic, mentioned in the introduction of this paper, said: “If thousands of tourists are going to be dumped on a Caribbean island with little more than beach, shopping, and a casino in mind, I’d rather they stay on Aruba than on other more fragile islands.” But to me, the passionate cultural preservation efforts of Arubans show that this expert should seriously reconsider their words.

Endnotes

1. Jonathan B. Tourtellot, '111 islands', National Geographic Traveler, November / December 2007, 108-127, there 127
2. Tourlettot, '11 islands', 127.
3. Harvey Armstrong & Robert Read. 'Tourism and Sustainable Growth in Small (Island) Economies.' In: Roberts, J.L., Nath, S., Paul, S., Madhoo, Y.N. *Shaping the Future of Small Islands*. (Singapore 2021), 97.
4. Robertico Croes, Seung Hyun Lee & Eric Olson, 'Authenticity in tourism in small island destinations: a local perspective' *Journal of Tourism and Cultural Change* 11 (2013) 1-2, 1-20, there 15.
5. United Nations. Goal 11 Make cities and human settlements inclusive, safe, resilient and sustainable. Retrieved 21-3-2023, from <https://sdgs.un.org/goals/goal11>.
6. Kerry Strand et al, *Community-based research and higher education: principles and practices*. (San Francisco 2003). 8-15.
7. Sharon Macdonald, *Memorylands: Heritage and Identity in Europe Today* (London 2014) 1.
8. Macdonald, *Memorylands*, 1
9. Artwell Cain, *A sense of belonging* (Edam 2017) 5.
10. In: David Mcmillan, 'Sense of Community', *Journal of Community Psychology*. 24 (1996) 4, 315-325, Voi. 24, No. 4. 315-325 (1996), there 315.
11. Cain, *A sense of belonging*, 5.
12. Although it is called different, their definition has been used in academic literature as similar to sense of community. See: Gervaise Debucquet et al, 'Sense of belonging and commitment to a community-supported fishery. The case of Yeu Island, France', *Review of Agricultural, Food and Environmental Studies*.101 (2020), 439-459.
13. Mcmillan, 'Sense of Community', 315-325.
14. In: Debucquet et al., 'Sense of belonging', 443
15. Luc Alofs, 'The Aruba Heritage Report' Aruba National Commission for UNESCO. (2008) 1-79, there 11.
16. Alofs, 'Aruba Heritage Report', 11.
17. Luc Alofs & Leontine Merckies, *Ken ta Arubiano?* (Oranjestad 1990) 12.
18. Alofs, 'Aruba Heritage Report', 11.
19. Alofs & Merckies, *Ken ta Arubiano?* 13.
20. Idem 28.
21. Idem 28.
22. Alofs, 'Aruba Heritage Report', 12.
23. Alofs & Merckies, *Ken ta Arubiano?* 65.
24. Idem, 65.
25. Information boards in Museum of Industry, San Nicolas.
26. Renwick Heronimo (museum curator) in discussion with the author, March 2023.
27. Renwick Heronimo (museum curator) in discussion with the author, March 2023
28. Renwick Heronimo (museum curator) in discussion with the author, March 2023.
29. Renwick Heronimo (museum curator) in discussion with the author, March 2023.
30. Renwick Heronimo (museum curator) in discussion with the author, March 2023.
31. Renwick Heronimo (museum curator) in discussion with the author, March 2023.
32. Schakels, 'de eigen identiteit van de Nederlandse antillen' (1970) 56, 1. Online collectie Nationaal Archief Aruba.
33. Schakels, 'de eigen identiteit van de Nederlandse antillen', 4.
34. Bhikhu Parekh, 'Common Citizenship in a Multicultural Society', *Round Table* 88 (1999) 351, 449-460, there 449
35. The interviews with Yahaira, Clifford, Renwick, Larissa and Ineke took place in Dutch. Quotes have been translated into English as literally as possible.
36. Yahaira (jurist and artist) in discussion with the author, March 2023.
37. Yahaira (jurist and artist) in discussion with the author,

- March 2023.
38. Yahaira (jurist and artist) in discussion with the author, March 2023.
 39. Yahaira (jurist and artist) in discussion with the author, March 2023.
 40. Jeanèdy Semeleer (manager of ARTISA gallery and music artist) in discussion with the author, February 2023.
 41. Jeanèdy Semeleer (manager of ARTISA gallery and music artist) in discussion with the author, February 2023.
 42. Jeanèdy Semeleer (manager of ARTISA gallery and music artist) in discussion with the author, February 2023.
 43. Anthony Croes (curator at Etnia Nativa) during a tour with the author, February 2023.
 44. Anthony Croes (curator at Etnia Nativa) during a tour with the author, February 2023.
 45. Renwick Heronimo (museum curator) in discussion with the author, March 2023.
 46. Renwick Heronimo (museum curator) in discussion with the author, March 2023.
 47. Clifford Rósa (chairman of Rancho Foundation) in discussion with the author, March 2023.
 48. Clifford Rósa (chairman of Rancho Foundation) in discussion with the author, March 2023.
 49. Renwick Heronimo (museum curator) in discussion with the author, March 2023
 50. MacDonald, *Memorylands*, 4.
 51. MacDonald, *Memorylands*, 4
 52. Yahaira (jurist and artist) in discussion with the author, March 2023.
 53. Mcmillan, 'Sense of Community', 322-323. .
 54. Lotte van den Heuvel (head of program and education Cas di Cultura) in discussion with the author, March 2023.
 55. Lotte van den Heuvel (head of program and education Cas di Cultura) in discussion with the author, March 2023.
 56. Lotte van den Heuvel (head of program and education Cas di Cultura) in discussion with the author, March 2023.
 57. Lotte van den Heuvel (head of program and education Cas di Cultura) in discussion with the author, March 2023.
 58. Armstrong & Read, 'Tourism and Sustainable Growth in Small (Island) Economies', 95.
 59. Armstrong & Read, 'Tourism and Sustainable Growth in Small (Island) Economies', 95.
 60. Central Bureau of Statistics Aruba, 'Tourism Satellite Account Aruba' (2022) 1-45, there 1.
 61. Renwick Heronimo (museum curator) in discussion with the author, March 2023.
 62. Manuel Venegas Sr. & Robertico Croes, 'Growth, Development and Tourism in a Small Economy: Evidence from Aruba', *International Journal of Tourism Research* 5 (2003) 5, 315-407, there 329.
 63. Economist Intelligence Unit. "Resurgence in tourism spurs economic activity in Aruba". <https://country.eiu.com/article.aspx?articleid=1411635724&Country=Aruba&topic=Economy&subtopic=Forecast&subsubtopic=Economic+growth>. Retrieved 2-6-2023.
 64. Armstrong & Read, 'Tourism and Sustainable Growth in Small (Island) Economies', 97.
 65. Idem, 100.
 66. Idem, 101.
 67. Jeanèdy Semeleer (manager of ARTISA gallery and music artist) in discussion with the author, February 2023.
 68. Yahaira (jurist and artist) in discussion with the author, March 2023.
 69. Yahaira (jurist and artist) in discussion with the author, March 2023.
 70. Clifford Rósa (chairman of Rancho Foundation) in discussion with the author, March 2023.
 71. Jeanèdy Semeleer (manager of ARTISA gallery and music artist) in discussion with the author, February 2023.

72. Clifford Rósa (chairman of Rancho Foundation) in discussion with the author, March 2023.
73. Clifford Rósa (chairman of Rancho Foundation) in discussion with the author, March 2023.
74. Anthony Croes (curator at Etnia Nativa) during a tour with the author, February 2023.
75. Anthony Croes (curator at Etnia Nativa) during a tour with the author, February 2023.
76. Jeanèdy Semeleer (manager of ARTISA gallery and music artist) in discussion with the author, February 2023.
77. Larissa (manager in small-scale tourism) in discussion with the author, March 2023.
78. Larissa (manager in small-scale tourism) in discussion with the author, March 2023.
79. Larissa (manager in small-scale tourism) in discussion with the author, March 2023.
80. Larissa (manager in small-scale tourism) in discussion with the author, March 2023.
81. Renwick Heronimo (museum curator) in discussion with the author, March 2023.
82. Renwick Heronimo (museum curator) in discussion with the author, March 2023.
83. Renwick Heronimo (museum curator) in discussion with the author, March 2023.
84. Rodrigo de Azeredo Grünewald, 'Tourism and Cultural Revival', *Annals of Tourism Research* 29 (2002) 4, 1004-1021, there 1004.
85. Armstrong & Read, 'Tourism and Sustainable Growth in Small (Island) Economies', 102-104.
86. Renwick Heronimo (museum curator) in discussion with the author, March 2023.
87. Renwick Heronimo (museum curator) in discussion with the author, March 2023.
88. Ineke Verberne (owner of 'Elements of Aruba') in discussion with the author, March 2023.
89. Ineke Verberne (owner of 'Elements of Aruba') in discussion with the author, March 2023.
90. Ineke Verberne (owner of 'Elements of Aruba') in discussion with the author, March 2023.
91. Ineke Verberne (owner of 'Elements of Aruba') in discussion with the author, March 2023.
92. Ineke Verberne (owner of 'Elements of Aruba') in discussion with the author, March 2023.
93. Ineke Verberne (owner of 'Elements of Aruba') in discussion with the author, March 2023.
94. Jeanèdy Semeleer (manager of ARTISA gallery and music artist) in discussion with the author, February 2023.
95. Macdonald, *memorylands*, 12.
96. Jeanèdy Semeleer (manager of ARTISA gallery and music artist) in discussion with the author, February 2023.
97. Clifford Rósa (chairman of Rancho Foundation) in discussion with the author, March 2023.
98. Jeanèdy Semeleer (manager of ARTISA gallery and music artist) in discussion with the author, February 2023.
99. Jeanèdy Semeleer (manager of ARTISA gallery and music artist) in discussion with the author, February 2023.
100. Jeanèdy Semeleer (manager of ARTISA gallery and music artist) in discussion with the author, February 2023.
101. Renwick Heronimo (museum curator) in discussion with the author, March 2023.
102. Renwick Heronimo (museum curator) in discussion with the author, March 2023.
103. Renwick Heronimo (museum curator) in discussion with the author, March 2023.
104. Renwick Heronimo (museum curator) in discussion with the author, March 2023.
105. Renwick Heronimo (museum curator) in discussion with the author, March 2023.
106. Bob McKercher & Hilary du Cros, *Cultural tourism. The partnership between tourism and cultural heritage management (Philadelphia 2002)* 84.
107. Mark Mansperger, 'Tourism and Cultural Change in

Small-Scale Societies', *Human organization* 54 (1995) 1, 87-94, there 92.

108. Mansperger, 'Tourism and Cultural Change in Small-Scale Societies', 92.
109. McKercher & du Cros, *Cultural tourism*, 84.
110. Renwick Heronimo (museum curator) in discussion with the author, March 2023.
111. Larissa (manager in small-scale tourism) in discussion with the author, March 2023.
112. Larissa (manager in small-scale tourism) in discussion with the author, March 2023.
113. Mary Mostafanezhad, 'Volunteer tourism and the popular humanitarian gaze', *Geoforum* 54 (2015) 111-118, there 111.
114. Mostafanezhad, 'Volunteer tourism and the popular humanitarian gaze', 112.
115. Idem, 111.
116. Antonia Besculides, Martha Lee & Peter McCormick, 'Residents' perceptions of the cultural benefits of tourism', *Annals of Tourism Research* 29 (2002) 2, 303-319, there 306
117. Besculides, Lee & McCormick, 'Residents' perceptions of the cultural benefits of tourism, 306.
118. Renwick Heronimo (museum curator) in discussion with the author, March 2023.
119. Jeanèdy Semeleer (manager of ARTISA gallery and music artist) in discussion with the author, February 2023.
120. Renwick Heronimo (museum curator) in discussion with the author, March 2023.
121. Renwick Heronimo (museum curator) in discussion with the author, March 2023.
122. Renwick Heronimo (museum curator) in discussion with the author, March 2023.

Interviews & primary sources

1. Anthony Croes (curator at Etnia Nativa) during a tour with the author, February 2023.
2. Clifford Rósa (chairman of Rancho Foundation) in discussion with the author, March 2023.
3. Ineke Verberne (owner of 'Elements of Aruba') in discussion with the author, March 2023.
4. Information boards in Museum of Industry, San Nicolas
5. Jeanèdy Semeleer (manager of ARTISA gallery and music artist) in discussion with the author, February 2023.
6. Larissa (manager in small-scale tourism) in discussion with the author, March 2023
7. Lotte van den Heuvel (head of program and education Cas di Cultura) in discussion with the author, March 2023.
8. Renwick Heronimo (museum curator) in discussion with the author, March 2023.
9. Schakels, 'de eigen identiteit van de Nederlandse antillen' (1970) 56, 1. Online collectie Nationaal Archief Aruba.
10. Yahaira (jurist and artist) in discussion with the author, March 2023.

Picture on the front page

Aruba Experience Café. Artist: @Yohaxart. Picture by the author.

Bibliography

- Alofs, Luc. 'The Aruba Heritage Report' *Aruba National Commission for UNESCO*. (2008) 1-79.
- Alofs, Luc & Leontine Merckies. *Ken ta Arubiano?* (Oranjestad 1990).
- Armstrong, Harvey & Robert Read. 'Tourism and Sustainable Growth in Small (Island) Economies.' In: Roberts, J.L., Nath, S., Paul, S., Madhoo, Y.N. *Shaping the Future of Small Islands*. (Singapore 2021).
- Azeredo Grünewald, Rodrigo de. 'Tourism and Cultural Revival', *Annals of Tourism Research* 29 (2002) 4, 1004-1021,
- Besculides, Antonia, Martha Lee & Peter McCormick. 'Residents' perceptions of the cultural benefits of tourism', *Annals of Tourism Research* 29 (2002) 2, 303-319.
- Cain, Artwell. *A sense of belonging* (Edam 2017)
- Central Bureau of Statistics Aruba, 'Tourism Satellite Account Aruba' (2022) 1-45.
- Croes, Robertico, Seung Hyun Lee & Eric Olson. 'Authenticity in tourism in small island destinations: a local perspective' *Journal of Tourism and Cultural Change* 11 (2013) 1-2, 1-20.
- Debuquet, Gervaise et al. 'Sense of belonging and commitment to a community-supported fishery. The case of Yeu Island, France', *Review of Agricultural, Food and Environmental Studies*. 101 (2020) 439-459.
- Economist Intelligence Unit. "Resurgence in tourism spurs economic activity in Aruba". <https://country.eiu.com/article.aspx?articleid=1411635724&Country=Aruba&topic=Economy&subtopic=Forecast&subsubtopic=Economic+growth>. Retrieved 2-6-2023
- Macdonald, Sharon. *Memorylands: Heritage and Identity in Europe Today* (Londen 2014) 1.
- Mansperger, Mark. 'Tourism and Cultural Change in Small-Scale Societies', *Human organization* 54 (1995) 1, 87-94,
- Mcmillan, David. 'Sense of Community', *Journal of Community Psychology*. 24 (1996) 4, 315-325, Vol. 24, No. 4. 315-325 (1996).
- Mc Kercher, Bob & Hilary du Cros. *Cultural tourism. The partnership between tourism and cultural heritage management* (Philadelphia 2002).
- Mostafanezhad, Mary. 'Volunteer tourism and the popular humanitarian gaze', *Geoforum* 54 (2015) 111-118,
- Parekh, Bhikhu. 'Common Citizenship in a Multicultural Society', *Round Table* 88 (1999) 351, 449-460.
- Strand, Kerry et al. *Community-based research and higher education: principles and practices*. (San Francisco 2003). 8-15.
- Tourtellot, Jonathan B. '111 islands', *National Geographic traveler*, november/december 2007, 108-127,
- United Nations. Goal 11 Make cities and human settlements inclusive, safe, resilient and sustainable. Retrieved 21-3-2023, from <https://sdgs.un.org/goals/goal11>.
- Venegas, Manuel Sr. & Robertico Croes, 'Growth, Development and Tourism in a Small Economy: Evidence from Aruba', *International Journal of Tourism Research* 5 (2003) 5, 315-407



Robin Prast, University College Utrecht

My research plan changed three times in total.

If there's one thing this field-research program has taught me, it's that research is not a linear process. My research plan changed three times in total. The first time it changed was the evening that I had to submit my preliminary research plan, the second time was after three weeks in Aruba when my initial stakeholder decided to ghost me, and the third time was when I decided that I wanted to separate my research for this course from my research for my thesis. I ended up conducting two researches at the same time, something that I would not necessarily advise to other students to do, but it did work out in the end!

While this (somewhat messy) research process has taught me a lot, it doesn't even come close to the numerous ways through which this trip changed my worldview. Coming from a country that used to be a colonial oppressor, Aruba has taught me a lot about coloniality as well as decoloniality. It is impossible to ignore all the ways through which this

island is still marked by its colonial past. At the same time, it is inspiring to see the numerous initiatives that aim to further develop and preserve Aruba's distinct identity and culture. While I thought I knew a fair bit about the impact humans have on their environment, this impact becomes painfully visible during your stay in Aruba. I never knew what dead coral looked like, until I learned that I had never seen coral that was still alive. This program makes you aware of the synergies and trade-offs (Eric's favorite words) that arise when one tries to create a more environmentally sustainable world. Even though it would have been easier to remain in my former oblivious state, I am grateful that I am now better educated on ways through which humans impact their environment and how we can change it.

Now that I'm done philosophizing about my learning process, I have to end this reflection on a high note. The last ten weeks were absolutely amazing! Life becomes less

stressful when you incorporate weekly salsa classes, late nights at Moomba, afternoon snorkeling sessions at Tres Trapi, and karaoke at Bugaloe. For someone who is terribly afraid of the ocean, I found myself suspiciously often either in or near the ocean. I think it might be the beginning of a delicate relationship between the ocean and I, all thanks to Aruba and its beautiful nature. I cannot wright a full

reflection without mentioning the incredible help I got from my supervisors Erik Mijts, Jocelyn Ballantine and Berteke Waaldijk. I also want to thank my beautiful friend Myrthe Knip, our jam session to country music made the stressful moments bearable. If you ever feel like life becomes too much, “Safe a horse, ride a cowboy”!



Bettering San Nicolas: the communal transformative capacity of church-based humanitarian interventionism

Robin Prast

Introduction

Since the emergence of the Christian faith, it has been intrinsically intertwined with aiding people in need. The church is often depicted as the strong pillar a community can lean on. During the twentieth century, numerous Christian NGOs arose, further underscoring the link between faith and humanitarian aid. Some contemporary theologians, including Benjamin Myers, are of the opinion that “the time between the ascension of Jesus Christ and his second coming should be characterized by encouraging and contributing to improving living conditions of people.”¹ Other theologians, like Themba Ngcobo, describe the role in a more general way, “a missional role of the church is to seek tangible solutions to address human pain and suffering”², emphasizing that this entails both spiritual and worldly suffering. This view of humanitarian aid as an intrinsic part of the Christian mission is still one of the core essentials of most present-day churches. This can be seen in numerous church-based initiatives, ranging from community-based food programs up to collecting money to build schools in developing countries. Churches often function as a place where people can come together, serving as one of the few remaining generators of strong social connections.³ Because of their function as a social generator, churches can also have a critical role as a community development agent.⁴ Research elsewhere indicates that faith-based organizations play a

critical role in community development,⁵ but none of this research was conducted in the Caribbean, which makes its applicability to the Aruban context unclear. This paper will focus on church-based humanitarian interventionism on a communal level, centering itself around the Aruban city of San Nicolas. While it is widely known that churches are active on a communal level, it is interesting to see if church-based initiatives are actually used by the wider community and to what degree they contribute to creating a more resilient community. This paper will thus center itself on the following research question: “What is the transformative capacity of church-based humanitarian interventionism on the San Nicolas community?”

In conducting academic research, it is important to keep the wants and needs of the researched group in mind. Therefore, the community-engaged research method, as defined by Kerry J. Strand et al. will be used. ⁶Acknowledging and appreciating local knowledge, this research is based upon semi-structured interviews and information gathered through surveys. This information is further complimented by the use of literature review originating from the field of religious studies as well as theology. The research incorporates Catholic as well as Protestant churches, but it limits itself to the Christian faith, not incorporating other religious belief-systems. Three local churches have been interviewed for this research: the Methodist Church, the Church of Christ,

and the Blue Army Apostolate of Fatima. To better understand the communal impact, ten local people were interviewed on their experience with the church and its humanitarian interventionism. In addition, fifteen surveys were completed by people living in San Nicolas or in the neighboring towns. The objective of these surveys was to gain a clear and more nuanced picture of the local experience.

The primary aim of this research is to further explore the concept of church-based humanitarian interventionism in the Caribbean context, since little research has been conducted in the region that fall under the scope of religious studies. This paper will also try to give insight into the sometimes invisible power-vacuum that can exist between church and government. I hope to provide the local community with an overarching insight into the different types of problems and experiences that are felt through the numerous layers of the community. Participants have given wonderful insights into the past and present of the San Nicolas community, knowledge that could be combined and integrated to create a more resilient San Nicolas of the future. It is important underscore the fact that this is an explorative research paper created with limited time and resources.

In order to gain a better insight into the mainstage of this research, this paper starts off with the local vision on contemporary San Nicolas, its culture, and its heritage. Highlights of the interviews with church leaders can be found in the second chapter, while the third chapter will delve into the interviews with the locals and their perception of church-based humanitarian interventionism in San Nicolas. The fourth chapter explores the information that was gathered through the surveys. The prefinal paragraph of this paper dives into the transformational capacity. The paper ends with some possible suggestions, focusing on viable possibilities to create a more resilient San Nicolas.

San Nicolas through her own eyes

The mainstage of this research paper is San Nicolas, the second largest city in Aruba, generally known as the cultural capital of the island. While contemporary San Nicolas is known for her street murals, the city used to be known for her oil-refinery “The Lago Oil and Transport Company”. The Lago was the source of a big change for Aruba. After the initial opening of the refinery in 1924, workers from all around the world came to San Nicolas to work for the oil-refinery, resulting in a multi-cultural community and a thriving city. This development cannot be marked as solely positive, having its own rippling effects. It created a monocultural economy, and also resulted in San Nicolas being the only locale in Aruba with a red-light district, something that widely goes against local cultural norms. The rise of San Nicolas’ infamous red-light district has been attributed to the fact that the city’s demographic during the height of the refinery’s operations consisted mainly of male immigrant workers who came to Aruba to work in the refinery. San Nicolas’ red-light district stood the test of time, perpetually being one of the city’s main markers. The closing and reselling of the refinery in 1985 marked a time of change for the city. While the Lago had roughly 8300 people in their staff around 1949, the number of personnel was reduced to 1350 in the 1980’s.⁷ Thousands of people lost their jobs, forcing locals to search for new job-opportunities. The closing of the refinery is also assumed to have contributed to the spread of drug-abuse, something that the city still faces to this day.⁸⁻⁹

To better understand San Nicolas, her culture, her history, and her contemporary problems, I interviewed several locals about their lived experience as a inhabitant of San Nicolas. One aspect that marked every interview concerning the identity of San Nicolas, is the closing of the refinery. In one way or another, every interviewee still feels its effects. During the interview with the pastor of the Church of Christ, he mentioned that the church’s targets are

specifically set on the families that were most affected by the closing of the refinery, stating that this is the group that to this day is still in big need of help.¹⁰

The Lago is strongly connected to a memory of better times, and many long for the past and hope that in the future San Nicolas will go back to the way it used to be. The road towards progress still seems to be unclear to many locals. The pastor described it as “The inability to see a future you never dreamed of”,¹¹ a sentiment that was endorsed during additional interviews with locals. Some hope the refinery re-opens, others place their trust in tourism. The general sentiment seems to be that the people of San Nicolas feel stuck, possibly due to generational trauma that came with the closing of the refinery and/or a not yet adapted outlook on the future.

For an outsider it was surprising to hear about the current troubled status of San Nicolas. While it is marketed to tourists as ‘The Cultural Capitol’, interviewees told me about San Nicolas’ bad reputation; a city marked by poverty and violence. Of the people that were interviewed, remarkably only young adults mentioned this bad reputation. While they stated that the situation was not as bad as some people made it appear to be, they did recognize that the city has its fair share of problems. The older generation appeared to be more concerned about the number of abandoned buildings in the city, mostly blaming it on young people migrating out of the area. Something that connected all the interviews together was the vision of San Nicolas as a *real* community. The one aspect that stood out from the rest, is that people generally look after each other. Community is seen as something vital for wellbeing by the interviewees; “Even when we don’t see it, we depend upon our community.”¹² Asked to describe the meaning of the word community, one man said: “It takes a village to raise a baby, community is about supporting each other, caring for one another and welcoming new members.”¹³ Especially the older generation tends to see the tight-knit community aspect as

an integral part of San Nicolas’ culture, part of her heritage. This sentiment could explain why the older generation is generally more concerned about the abandoned buildings in the city; it is visual proof that the community is changing. With the perceived rise of individualism, people fear that communal cohesion is slowly eroding, and are eager to protect this part of their heritage.

Holy perspectives on the bettering of San Nicolas: interviews with the local churches

To gain an insight in local churches’ driving factors, current projects, and future perspectives concerning the bettering of San Nicolas, semi-structured interviews were conducted with representatives of three local religious institutions: the Blue Army Apostolate of Fatima, the Church of Christ, and the Methodist Church.

The Blue Army Apostolate of Fatima, located in the center of San Nicolas, started out as a convent dedicated to the saint Fatima, but overtime changed its function to serve as an apostolate, a place for worship and a center for religious retreats. Blue Army has strong ties to the Santa Teresita Church, since they fall under the same parish. This means that most of the community efforts are organized together but take place at the Santa Teresita chapel, since it serves as the central point of the parish. I was told that Blue Army’s main purpose is the spreading of the message of Maria Fatima. This does not mean that this is the sole focus of the apostolate. With the Santa Teresita church, Blue Army organizes the distribution of food and clothing to those in need, stating that everyone in need (even the non-Catholic) can come there and ask for help. When asked about financial aid, the representative made it clear that this is not part of the resources that the church offers to the community: “If people need money, they should go to the government, not the church”. One of the problems the apostolate faces, is a decline in church attendance. This decline in attendance

stood out in other interviews with young adults as well, as people who identify themselves as Catholic tend to only go to church only a couple of times a year. A lot of young people also move abroad for their studies, creating a further decline in the number of church members. While there seems to be a general decline in church attendance in Aruba, the Blue Army Apostolate of Fatima is the only religious institution that labeled this trend as a one of their main challenges. The decline in church members has not only an effect on church attendance, but also on the amount of resources the church can offer the community, since it is partly dependent on donations from the churches' followers. The representative calls out to Arubans to stay in Aruba, work together and develop their own country, stating: "I am a folks-child, and I will stay a folks-child, I hope the San Nicolas community will be brought into action so we can work together like we used to".

The Church of Christ is a fairly new church in San Nicolas that aims to help their members in two different ways, firstly through spiritual guidance and secondly through practical help. These ways of helping are said to intertwine, "We believe that a person is made out of three things: a body, a spirit, and a soul; you cannot separate one from the other." This theological perspective that the church is responsible for all major aspects of human life, is a development that has gained significant popularity over the last century.¹⁴ This worldview is integrated in the ways the church tries to help the San Nicolas community; it provides spiritual as well as practical help for people inside and outside their church community. When asked whether or not the aim of their community service is to gain new members, the representative answered: "Of course our main task is always to spread our message, but people cannot fully listen to my message if they are hungry, that is why we also provide the necessary practical help." The church runs a food program as well as a rehab program. The rehab program is mainly targeted towards Christians since a significant part of the program is based on Christian principles. The food

program provides food for families in need on Tuesdays and Thursdays, to a total of 26 people on a weekly basis, of whom only two are members of the church congregation, which shows the church's community outreach. While the church mostly focuses on families located in San Nicolas, it also provides food for two families outside of San Nicolas. One of the problems the church faces concerning their community programs, is the lack of funding. The church does not receive any type of government funding and relies on the donations of their followers to be able to provide help to the community. The government is said to prioritize Catholic and Anglican churches, which makes it harder for other Christian denominations to persevere. One of the ways through which the church is still able to provide the necessary help towards the community, is through donations coming from outside the church, from local residents, but also from the Hindu foundation on the island. The Church of Christ hopes to join more inter-faith collaborations in the future; this way they could broaden their reach and efficiently help the San Nicolas community.

The last church interviewed for this explorative research was the Methodist Church. The church is part of a Methodist circuit that is made up of three congregations based in San Nicolas, Brazil, and Wesley. Like the other churches, the Methodist church also provides help for people inside as well as outside their congregation. The church representative underlined the importance of the church as a backbone and safe haven, "The church helps people to be part of something, it functions as a cushion for people who are having a hard time"¹⁵. The church is renowned for its Meals-on-Wheels program, which will celebrate its 55th anniversary this year. In addition, the church also assists community members through their care-fund, which can provide help to people by giving away food-vouchers or through a monthly assistance. This aid reaches further than just San Nicolas, including families in Pos Chiquito and Paradera. Currently, the church is able to provide help to 82-84 families, feeding them twice a week.¹⁶ Most of the people

who make use of this help-mechanism are said to have no direct connection to the church. Community is seen as vital for the human existence, people need a community to rely on and support each other. This is why the church aims to reach people inside as well as outside the congregation, further connecting the community.

Local perspectives

Insight into the locals' experience and their connection to the church was gathered through extensive interviews with ten local residents. The aim of these interviews is to better understand what the local perspective is on the churches and their contribution to the development of a more resilient San Nicolas community. The majority of the interviewees are between the ages of 16-30, which creates a picture of San Nicolas that is mostly sketched through the eyes of the younger generation. Their picture of San Nicolas is more diverse than the one portrayed on tourist websites. It is marked by a sense of community, but also by drug-abuse, poverty, and violence.

Notably, all of the interviewees were brought up in a religious household, with most of them coming from Catholic families. When it came to their current belief-systems, most of the young adults stated that they still believe in God, but no longer attend church on a regular basis. When they are asked why they no longer go to church, most answered that they feel like every sermon is a repetition of the same old Christian message. While this might sound like the younger generation has a negative outlook on religion, they view religion as one of the reasons San Nicolas is less violent than it used to be. One interviewee stated: "San Nicolas used to be quite a violent place, but I feel like the churches were pretty influential when it came to changing the community. Local churches taught the community a different way of living through their preaches. Religions pose certain restrictions which are necessary to prevent chaos."¹⁷ While none of the younger interviewees ever received any direct

aid from a local church, they were aware of the presence of some community-based church-led initiatives. One specific church-led initiative that stood out was the Meals-on-Wheels program led by the Methodist Church, with one of the interviewees stating that he volunteered with the program before. Another interviewee mentioned that her church (Famia di Dios) focuses mainly on the teenagers and young adults, stating that they face a lot of problems. She also referred to the Santa Teresita church and their function in the community. While she recognized that the church organizes frequent soup kitchens, she thought they were only available to members of the church, in contrast to her own church, whose aid programs are said to be available to everyone. Most of the young adults that were interviewed know of people who are being helped by a church in some type of way, but these people mostly consist of distant acquaintances. The participants mention that the biggest problem is not any form of lack of effort on the church's part, but mostly the fact that people in need do not want help from a religious institution. The religious aspect in these aiding programs tends to create a fear of reciprocal expectations, something which they would prefer to avoid.

The older adults that were interviewed generally had a different outlook on the church, with three out of the four interviewees being loyal members of the Catholic church. Their different perspective became most apparent when it came to their vision on the perceived struggles San Nicolas was facing. Whereas the younger generation mentioned gangs, violence and poverty as San Nicolas' biggest problems, the three senior Catholic participants that were most concerned with the amount of empty buildings in the city and the migration of young people leaving Aruba. Regarding the role of churches in San Nicolas and their communal contribution, the three Catholic participants stated that the churches are of much significance to the older generation, but that the younger generation tends to neglect their Catholic roots. This phenomenon is accredited to the fact that the church is not 'trendy' enough for the

young people, and that youngsters would feel ashamed to be seen in a church building because it is not deemed to be 'cool'. "We cannot compete with the fun that a non-Catholic life claims to offer, it is seen as desirable by the youngsters."¹⁸ The three Catholic participants have strong ties to the Santa Teresita church. Asked how they view the help the church provides to the community, they state that everyone can ask for help and they will receive it from the church. Although everyone is allowed to ask for help, one of the participants highlights that those who are most likely to ask for help are members of the church, since every other religious institution has their own help mechanisms.

The final interview that was conducted for this paper, was with a non-religious woman in her thirties that will be referred to as 'Monique' (not her real name). Monique was very critical when it came to the help churches provide in their local community, stating that churches only address small and insignificant problems while they stay silent when it comes to larger societal problems. To substantiate her statement, she used the example of several church banners she saw that stated: "Save our children!". Her problem with the banners was that they addressed the fact that registered same-sex partnership was now legally allowed, and apparently forms a great threat to our children, but they did not address (apparent) problems with sexual abuse of children. When Monique was asked how she felt about the initiatives that are carried out by many churches, for example food-distribution, she expressed a skepticism about the amount of help they provide: "People donate 10% of their monthly income to the church, you would think that churches could have made more significant progress with all that money, especially when all the pastors drive in expensive cars."¹⁹ When it comes to the scope of the church's outreach, Monique overtly states that they only help people within their own church-community. When churches do venture outside their religious community, they do it solely to interfere with other people's life. Monique wishes that the government would provide more

social resources, that way the church would solely become a place for spiritual guidance and not for basic human needs like food and clothing. "People are now dependent on church-led initiatives because we don't have social structures like they have in The Netherlands, for example the Dutch 'voedselbank'. If we had those kinds of social structures, the church would stop interfering in the broader community?". This interview visualizes the power vacuum that seems to exist in Aruba. Due to a lack of centralized government support, local religious institutions fulfill the government's task by providing the necessary resources to the community.

How far does the outreach reach?

Surveys were sent out to gain a more nuanced perspective on San Nicolas based church-led initiatives and their transformative capacity and to further substantiate the interviews. In total 15 people completed the survey; 50% of them lived in San Nicolas, 37.5% in Savaneta, 6.3% in Pos Chiquito and 6.3% in Santa Cruz. A large majority, 87.5%, identified themselves as Catholic, while the other 12.5% identified themselves as Protestant. These data give us an insight into the religious sentiments that exist in Aruba. While the sample group is small, it is still notable that all of them identified themselves as religious, specifically religious within the Christian denominations. This becomes even more notable given that a majority of the respondents (68.8%) only go to church a couple of times a year.

The church-led activities that focus on the bettering of the San Nicolas community that are most apparent through the survey are: food distribution, distribution of free clothing and spiritual guidance. Most of the people who completed the survey have never made use of any of these resources; out of the 15 people, 3 of them made use of church-led initiatives at some point in time. A large majority of respondents (66.7%) knew someone who had received aid from a church, most of them receiving either food or

clothing. When people were asked to what degree they were satisfied with the way the church aids the community, the better part of them were very satisfied. Due to the small scale of this survey, no broader generalizations can be made. However, when this data is taken with the information gathered through the interviews, it becomes apparent that churches are still of significance for the development and well-being of the San Nicolas community. While people go to church on a less frequent basis, they still identify themselves with their faith of origin and fall back on their religious community when times get rough.

Transformational Capacity

The final question this paper addresses is the degree to which church-based humanitarian interventionism has the capacity to transform the community. To answer this question, it is important to clarify first what we mean by transformational capacity. Churches can be transformative agents due to their ability to create change from a grassroot level,²⁰ but in order to do that they would have to take the right actions and reach the right people. To transform something or someone, some kind of development or change must occur. In this case, the development is centered around creating a more resilient community. What makes this question complicated is the fact that development is subjective; what one person accepts as development might be interpreted by another as no development at all.²¹ While most interpretations of development are economically oriented, this paper will employ the definition of Paul Collier: “To my mind, development is about giving hope to ordinary people that their children will live in a society that has caught up with the rest of the world. Development should help people to grow out of their current situations.”²² While this definition clarifies what is to be considered ‘development’, this type of development is not intrinsically sustainable. To create a more resilient community, the development must be sustainable. The definition of sustainable development that was coined during the World Commission on Environment

and Development was: “Sustainable development is a development that meets the needs of the present without compromising the ability of future generations to meet their own needs.”²³ In this research, it has become clear that a lot of people in and around San Nicolas have received help, mostly in the form of food or clothing, through church-led initiatives. However, it is not clear whether these interventions help the community in becoming more resilient. Most church-led initiatives provide the community in their basic needs, and while this is incredibly important, it does not seem to create much communal change, or development as defined in this paper. The focus on primary needs creates an aid system that is focused on the short-term, and unable to create a long-term self-sufficient future. One way through which church-led initiatives are reported to have been very transformational is when it comes to reducing of violence in the city. Public sermons made it possible for people to come together and reflect on the type of community that they want to be.

Conclusion

One aspect that frequently arose during the interviews, was the sentiment that San Nicolas lacked a vision for the future. The city is said to be stuck, either in the past or in the present. This however does not mean that people have not thought about their future. Most locals have thought about their future; everyone that has been interviewed for this paper has their own specific ideas on what needs to change for San Nicolas to become a better and more resilient place. It is interesting to note that the aspects of San Nicolas that are in need of change according to the interviewees, differ dramatically between different age/social groups. What did become apparent is that many of the interviewees lacked the feeling of a close-knit community, stating that people used to look after each other more in the past.

Churches could function as a development agent in both of these problems. Due to their close link with the community, they could function as a place where people can collaborate

on their ideas concerning the development of San Nicolas, setting up broader communal initiatives. At the same time, churches are also one of the key players in creating more tight-knit communities, being the social link between many groups of people. At the present moment, churches provide help to a significant part of the San Nicolas community, but does not function as a catalyst for change. The help is short-term in nature, focusing mainly on matters pressing in the present. For churches to create initiatives that have a larger transformational capacity, they would have to focus more on the future; in what direction do they want the community to go? What are the community's long-term needs and desires? In order for churches to be able to provide these kinds of humanitarian intervention, full local participation would be necessary. Development is about people. Only through local participation can churches provide sustainable initiatives to appropriately better San Nicolas. The strengths, resources, and potential within a community need to be utilized to bring about change and development.²⁵

A societal phenomenon that became apparent, is that fewer people go to church on a regular basis. However, this is not in line with secularization thesis as coined by sociologist Max Weber in the 1930's. While citizens of San Nicolas are going to church on a less frequent basis, almost all the interviewees identified themselves as religious. It should be noted that, even though people sometimes rarely go to church, the church still is of so much importance in people's individual lives as well as the broader community. As noted, 66.7% of the people who completed the survey know someone who has received help from the church, underscoring its communal significance. This can be linked to the interview with Monique, who argued that people are dependent on help from their church-community, because the government does not provide the adequate help. The problems San Nicolas is facing are too broad, too complicated, and too expensive for churches to solve, but this does not mean that churches cannot help the

government in solving these problems. Churches have close ties with the community, which makes them key players for implementing sustainable changes, "Change in the societies at the very bottom must come predominantly from within."²⁶ Based upon conversations with local stakeholders and an extensive literature review, this paper argues for urging the government to start collaboration programs with local religious institutions. Important in this collaboration, is that the government involves a variety of faith-based institutions, not just Catholic churches, so there are no social groups that are left out of the picture. The goal of these collaborations would be for religious institutions to have more resources to offer to the community, and for the government to be able to incorporate local voices in their future policies. Inspired by the collaboration between the Church of Christ and the Hindu temple, this paper also argues for religious organizations to collaborate in their community-based programs, so that church-based humanitarian interventionism can have a more significant transformational impact. This would not just mean more resources, but it would also increase the scope of the outreach.

Acknowledgements

All the critical information this paper is based on, has been put forward by the wonderful people who were willing to work together with me on this research. Every interview provided me with advanced and crucial insights, every time shedding light on a new societal phenomenon. I want to thank all the people who took time out of their day to help me write this paper, either via interviews or surveys. I especially want to thank Jeanmichel Kelly for all the ways through which he helped me during this research process, I could not have written this paper without him. For all the people that helped me, thank you.

Endnotes

1. B. L. Myers, *Engaging globalization: The poor, Christian mission, and our hyperconnected* (Grand Rapids: World Baker Academic, 2017), 175.
2. Ngcobo, Themba and Thinandavha D. Mashau1. 2022. "The agency of the church during COVID-19 and beyond: Koinonia and ubuntu in the context of poverty and unemployment in South Africa." *HTS Theologiese Studies* 78(4): 2.
3. Robert Putnam, *Bowling Alone: The Collapse and Revival of American Community* (New York: Simon & Schuster, 2000), 72.
4. Magezi, Vhumani. 2019. "Doing pastoral care through church-driven development in Africa: Reflection on church and community mobilisation process approach in Lesotho." *HTS Teologiese Studies* 75(4), 1.
5. Vhumani, Magezi and Patrick Nanthambwe. 2022. "Development and the role of the church: Exploring public pastoral care positioning within congregational ministry." *Verbum et Ecclesia* 43(1): 3.
6. Cutforth, N., Strand, K.J., et al. "Origins and Principles of Community-based Research" in *Community-engaged research in higher education: principles and practices*, (San Francisco: Jossey-Bass, 2003).
7. Biblioteca Nacional Aruba. 2008. "De Geschiedenis van Lago op Aruba." *Departamento Arubiana*.
8. Interview with the Church of Christ, March 8th, 2023.
9. Group-interview, March 19th, 2023.
10. Interview with the Church of Christ, March 8th, 2023.
11. Ibid.
12. Interview with the Methodist Church, March 9th, 2023.
13. Group-interview, March 19th, 2023.
14. Quoted in: Vhumani, Magezi and Patrick Nanthambwe. 2022. "Development and the role of the church: Exploring public pastoral care positioning within congregational ministry." *Verbum et Ecclesia* 43(1): 2.
15. Interview with the Methodist Church, March 9th, 2023.
16. Ibid.
17. Group-interview, March 19th, 2023.
18. Group-interview, March 22, 2023.
19. Interview with 'Monique', March 20th, 2023.
20. Mutemwa, David, René Hattingh-Rust and Willem J. Hattingh. 2018. "Guidelines for effective community transformation from a practical theological perspective: An African case study" *Die Skriflig* 52(1): 4.
21. Vhumani, Magezi and Patrick Nanthambwe. 2022. "Development and the role of the church: Exploring public pastoral care positioning within congregational ministry." *Verbum et Ecclesia* 43(1): 2.
22. Paul Collier, *The bottom billion: Why the poorest countries are filing and what can be done about it* (Oxford: Oxford University Press, 2007) 12.
23. Quoted in: Vhumani, Magezi and Patrick Nanthambwe. 2022. "Development and the role of the church: Exploring public pastoral care positioning within congregational ministry." *Verbum et Ecclesia* 43(1): 2.
24. Quoted in: Hancox, Deborah. 2019. "Towards defining the Christian development organization." *HTS Theologiese Studies* 75(4): 5.
25. Mutemwa, David, René Hattingh-Rust and Willem J. Hattingh. 2018. "Guidelines for effective community transformation from a practical theological perspective: An African case study" *Die Skriflig* 52(1): 8.
26. Paul Collier, *The bottom billion: Why the poorest countries are filing and what can be done about it* (Oxford: Oxford University Press, 2007) 71.

Bibliography

- Collier, Paul, *The bottom billion: Why the poorest countries are floundering and what can be done about it* (Oxford: Oxford University Press, 2007).
- Cutforth, N., Strand, K.J., et al. *Origins and Principles of Community-based Research in Community-engaged research in higher education: principles and practices* (San Francisco: Jossey-Bass, 2003).
- Hancox, Deborah. 2019. "Towards defining the Christian development organization." *HTS Theologiese Studies* 75(4): 1-10.
- Jamoul, Lina and Jane Wills. 2007. "Faith in Politics." *Urban Studies* 45(10): 2035-2056.
- Magezi, Christopher and Kimion Tagwirei. 2022. "A critical assessment of Church and political engagement in Zimbabwe under the new dispensation." *Verbum et Ecclesia* 43(1): 1-12.
- Magezi, Vhumani. 2019. "Doing pastoral care through church-driven development in Africa: Reflection on church and community mobilisation process approach in Lesotho." *HTS Theologiese Studies* 75(4), 1-11.
- Magezi, Vhumani, and Patrick Nanthambwe. 2022. "Development and the role of the church: Exploring public pastoral care positioning within congregational ministry." *Verbum et Ecclesia* 43(1): 1-10.
- Mutemwa, David, René Hattingh-Rust and Willem J. Hattingh. 2018. "Guidelines for effective community transformation from a practical theological perspective: An African case study" *Die Skriflig* 52(1): 1-11.
- Myers, B. L., *Engaging globalization: The poor, Christian mission, and our hyperconnected* (Grand Rapids: World Baker Academic, 2017).
- Nell, Elsabé and Ignatius Swart. 2016. "Religion and development : the rise of a bibliography." *HTS Theologiese Studies* 72(4): 1-27.
- Ngcobo, Themba and Thinandavha D. Mashau. 2022. "The agency of the church during COVID-19 and beyond: Koinonia and ubuntu in the context of poverty and unemployment in South Africa." *HTS Theologiese Studies* 78(4): 1-8.
- Putnam, Robert, *Bowling Alone: The Collapse and Revival of American Community* (New York: Simon & Schuster, 2000).
- Vester, Pieter. 2022. "Perspectives on church and mission: The missional church and metaphors for the church." *Verbum et Ecclesia* 43(1): 1-9.
- Woolnough, Brian. 2011. "Christian NGOs in Relief and Development: One of the Church's Arms for Holistic Mission." *Transformation* 28(3): 195-205.



Thijn Fruijtier, University College Utrecht

Step by step becoming more independent.

A year and a half ago, I came across the so-called 'Aruba project'. It immediately caught my attention, because it combined the two possibilities I had for the practical part of my education that I was in doubt about: doing an internship and studying abroad. The Aruba project ended this hesitation and pulled me towards the island. And it did not disappoint; I have been impressed by the beauty of the island, while also realizing the difficulties that Aruba faces, the kindness of Arubans and the pleasant atmosphere of the island. And this experience did learn and bring me a lot: doing an individual research, interacting with relatively new people, tasting the Aruban culture, being far away from home and step by step becoming more independent.

My study discipline International relations has given me multiple options for a research topic, as the relationship between Aruba and the Netherlands is an interesting one, given their history and its resulting current relation.

Ultimately, I chose for a topic that is very present in Aruba's development wishes: the possible change from Dutch to Papiamentu as the instruction language at schools. This project has therefore given me the opportunity to combine my study discipline with another interest I have: language. And specifically the social aspects of a language; what does the language mean for a certain society, how is it embedded in their culture and what might perhaps be some difficulties regarding a language? These questions are also all relevant when looking at the situation of Aruba. I have experienced that Papiamentu forms an important part of the Aruban culture and identity; it is the way for Arubans to express their feelings, talk with their friends and family, and the language they hear on the street, in the supermarket, on television and on the radio. The beauty, but sometimes also difficulty regarding the language aspect in Aruba, is the fact that they have a multilingual society, consisting of Papiamentu, English, Spanish and Dutch. This brings the

society a certain social wealth, but it also brings discussion about what language should be used in what situation, for instance at school.

While doing my research about this topic, I have noticed that this is an intense discussion that has been going on for centuries and where multiple people have a strong opinion about this topic. Because of especially this last point, participants of my research reacted positively on my

request to interview them for my research and were eager to get involved in the discussion. I would therefore like to thank all the people that have participated in my research; you have made my research possible, interesting and relevant for the Aruban community. I myself am glad that I have participated in the Aruba project; it has broadened my knowledge, independence and different sets of skills, and it was altogether a special experience.



(Bron: NRC Nieuws, 'Stop op Aruba met examens in het Nederlands' (11 may 2018), <https://www.nrc.nl/nieuws/2018/05/11/stop-op-aruba-met-examens-in-het-nederlands-a1602653> (28 March 2023).

A switch from Dutch to Papiamentu

The Aruban debate on the possible switch to Papiamentu as the instruction language within the Aruban education system

Thijn Fruijtier

Abstract

The instruction language at Aruban schools is a discussion that has been going on for decades. Some say that Dutch is more suitable to be the language of instruction, because of its usability for legal aspects and future educational opportunities, while others argue that Papiamentu should be the instruction language; this would make more sense, since that is the mother language of most Aruban students. Pupils would become insecure by having to speak Dutch in class and it would adversely affect their school results. In line with this last argument, the 'Directie Onderwijs' produced an advice for a new language policy at schools, in which Papiamentu will have a more prominent role. The aim of this research was to, by means of interviews and class visits, poll the reactions of different groups in Aruba to this advice. These methods have helped to show that the participants of this research do not completely recognize the disadvantages of Dutch that are being mentioned and therefore do not necessarily feel the need for a change in the language policy for schools. On the other hand, they do acknowledge the value of Papiamentu. The issue could therefore be seen as a dilemma between head - wanting to keep Dutch because of its importance in the future - and heart; valuing Papiamentu as part of the Aruban culture and identity.

Introduction

Aruba is a former colony of the Netherlands and that colonial period has left its traces. The Dutch influence is still very much visible in the Aruban education system; in many schools(-levels) the instruction language is Dutch and many of the school methods that are being used are also Dutch. This research will be about this topic specifically; Papiamentu as the instruction language in Aruban schools. For centuries, Dutch has been the instruction language at schools, as a result of the colonial period in Aruba. There has been discussion about this, because some people argue that it is not natural and useful to teach students in a language that is not their first language. This might result in poor school performance, because students have trouble understanding the course material due to the language barrier. They get taught in a language which they do not hear in their daily life. This is the so-called 'exposure gap'; the fact that a child has too little exposure to a particular language and therefore does not master the language adequately.¹ And it also falls short in improving and valuing Papiamentu, because that language is being spoken less.

To keep maintaining this important part of the Aruban culture, there is an advice for a new language policy for schools. This advice states that Papiamentu would have to be the main instruction language, and other spoken

languages in Aruba (English, Spanish and Dutch) will be courses which students can choose from.² This new policy might contribute to the well-being of the Aruban community, because it recognizes the fact that Papiamentu is an important aspect of their culture and also of their identity. Papiamentu is the language Arubans use in their daily lives, to express their feelings, to communicate with each other, and it is the language most Arubans feel most comfortable with. It could therefore be that speaking and listening to this important language in schools, where students spend quite some time, contributes to the sustainability of the Aruban culture and language, and also to the well-being of Arubans.

It could also be that being taught in your first language, will improve students' school results. It might take less time to understand the course material, because this material is being explained in the language that students are familiar with, and not in a language they are not proficient in, so they would first have to translate it. Taking lessons in Papiamentu could therefore make Aruban students more comfortable and confident, which again contributes to their well-being. In order to achieve this, it is important that the government and staff of schools (teachers, deans, principals) work closely together, so the school staff could explain what is needed for this new policy and how this needs to be implemented and the government can make this work. It might also be important that there will be getting rid of the traditional/old-fashioned thought that Dutch is the language for schools and Papiamentu for the daily life.

I think this research is relevant, because it will help to monitor the reactions to this new language policy in schools. This policy will hopefully provide an environment where Aruban students incorporate the course materials better, feel more comfortable speaking up in classes and asking questions, and (learning to) value their culture. These are important aspects of what the United Nations called Sustainable Development Goal 4: "Ensure inclusive and

equitable quality education and promote lifelong learning opportunities for all".³ Papiamentu as the instruction language might benefit the education of Aruban students and these students, like any other child, have the right to get a good education. The instruction language in Aruban schools is a centuries-old discussion and therefore several research studies have already been done. This small-scaled research will generate some more and up-to-date data and will specifically look at the reactions of different groups on the language advice from the 'Directie Onderwijs'.⁴

A big name when it comes to this topic is Joyce Pereira. In her dissertation she polled the attitude of Arubans towards the Dutch and Papiamentu language.⁴ According to this research, most Arubans are positively disposed towards a shift in the language policy on schools, making a switch from Dutch to Papiamentu. Because this research is familiar to the research I will be doing, Pereira's work will serve as an important starting point. Furthermore, Eric Mijts with, among other things, his work 'Op de Antillen en Aruba is Nederlands een vreemde taal' has largely contributed to the studies about the role of the Dutch language in the Caribbean and specifically within the education system.⁵ Gert Oostindie and Alex van Stipriaan complement this information by supplying data on the history and nation building of the Caribbean.⁶

The main research question of this paper is: *what is the consensus of Arubans regarding the possible switch from Dutch to Papiamentu as the instruction language at Aruban schools?* Supported by the following subquestions: *What are the consequences of the Dutch influence in the Aruban education system? Why would it be helpful to make Papiamentu the main instruction language at schools? What does Papiamentu mean for the Aruban society?*

For this research, people from different perspectives were interviewed, in order to gather a broad range of opinions and thoughts. Four students were interviewed, to represent

the student perspective, as well as the teachers' perspective, which included two teachers, the perspective of the 'Directie Onderwijs' who created the new language advice and a perspective from the Fundacion Lanta Papiamentu; an organization that supports Papiamentu and therefore in this research explained the value of Papiamentu. In addition to this, class visits were held, in order to observe the reactions of pupils when being taught in Dutch. These class visits took place in grade levels 4, 5 and 6, consisting of children from the age of eight to twelve. Both Papiamentu and education are an important part of the Aruban society. With my research I hope to see how these two components could work well together, so that it will benefit Aruba.

Chapter 1: The pitfalls and difficulties of the current aruban school language policy

The Caribbean islands of our Kingdom have an eventful political history with ever-changing forms of government. For three centuries, starting in 1634, the islands were subject to mainly Dutch colonial administration. The political name of the colony at that time was "Curaçao and Dependencies". More self-government came in 1954 with the establishment of the Charter for the Kingdom of the Netherlands. The new country of the Netherlands Antilles was formed by Aruba, Bonaire, Curaçao on the one hand and St. Maarten, St. Eustatius and Saba on the other. Broadly speaking, the Charter implies administrative autonomy for internal matters, while subjects such as defense and foreign relations are Kingdom affairs. Education policy thereby became an Antillean responsibility. In 1986, Aruba received the 'Status Aparte', which made the island an independent part of the Dutch kingdom.⁷

Fundamentally, Papiamentu is a Afro-Portuguese creole language, as a result of the slavery period. The sentence

structure and vocabulary however have expanded over the years to include borrowings from the other languages spoken on the island; Dutch, English and Spanish, but its own identity and unique rhythm have remained.⁸ Papiamentu was an unforeseen result of a history of European colonialism and African slavery on Caribbean ground.⁹ It has therefore created an ambiguity for Aruba about its national identity; dealing with the fact that their language which Arubans are so proud of, stems from the slavery period in which Arubans were being controlled by the colonizer, also in the field of education.¹⁰ The question what language should be the instruction language within the education system is a centuries-old discussion, starting from the 19th century when the Aruban education started. Aruba was still a colony of the Netherlands then and therefore most school materials and the instruction language were Dutch(-oriented). More specifically, in the 19th century, Papiamentu was spoken in schools until Dutch subsidies made it a condition that classes be taught exclusively in Dutch.¹¹ On June 6, 2003, Papiamentu, alongside Dutch, was introduced as an official language in Aruba. And on March 6, 2007, the parliament of the Netherlands Antilles passed a law recognizing Papiamentu, alongside Dutch and English, as an official language.¹² 'Directie Onderwijs' employee Vanessa Scholing-Pietersz explains that the question of the ongoing discussion was always 'how do children learn best?'¹³ And although every person involved wants the best for Aruban children, this topic remains a complicated issue.

The policy regarding the instruction language at Aruban schools as it is used now, is the following: the school-life of a child starts in the kindergarten where the used language is Papiamentu. At the age of six, children go to primary school where the lessons and methods are in Dutch. These methods are based on students who have a Dutch vocabulary of about 6000 words and whose native language or at least the surrounding language is Dutch. For Aruban pupils however, this is not the case; Dutch is a foreign language for

them. Dutch is one of the official languages of Aruba and is more a governance language than a social language. It is therefore not a language children hear in the supermarket, on the radio, on television, on social media or when they talk to friends and family.¹⁴

The student participants of this research explain that the instruction language in secondary school in practice differs somewhat. The official instruction language at all school levels is Dutch, but the lessons on the level ‘mavo’ are also being supported by Papiamentu. The ‘colegio’, which consists of the levels ‘havo’ and ‘vwo’, sticks more to Dutch.¹⁵ A class visit to a primary school showed that this specific primary school pays a lot of attention to the Dutch language. They have the course ‘Dutch language’ in which teachers teach the children about Dutch grammar rules.

Here is an example of an assignment of the Dutch language lesson from class 4, where long and short vowels is the subject of the lesson:¹⁶

1. Hier zijn de foto's van de skiwedstrijd. (Here are the photos from the ski race.)
2. Helaas ben ik de foto's vergeten. (Unfortunately, I forgot the photos.)
3. Wat stond er op de vergroting dan? (What was on the enlargement then?)
4. Een heleboel ski's neem ik aan. (A lot of skis I suppose.)
5. Ja, en alle figuren die meedoen. (Yes, and all the figures that participate.)
6. De winnaars hebben bekens in hun hand. (The winners have trophies in their hands.)
7. Op de achterkant zag je naaldbomen. (On the back you saw coniferous trees.)
8. Daartussen de gondels van de lift. (In between the gondolas of the elevator.)

Apart from the language aspect, another thing stands out when looking at this assignment, namely the examples that

are being used in these sentences. The word ‘ski’s’ (skis) and ‘gondels’ (‘gondolas’) are words that Aruban pupils are not familiar with, because those things are not present in Aruba. The teacher explains these words to the pupils, but the teacher does acknowledge the fact that because of these unfamiliar words, some students get distracted from the actual assignment.

The core of the problem lies in the fact that Dutch is not the mother language of most pupils. It is in fact the fourth language of Arubans, after Papiamentu, English and Spanish, as being visually explained in this image:¹⁷

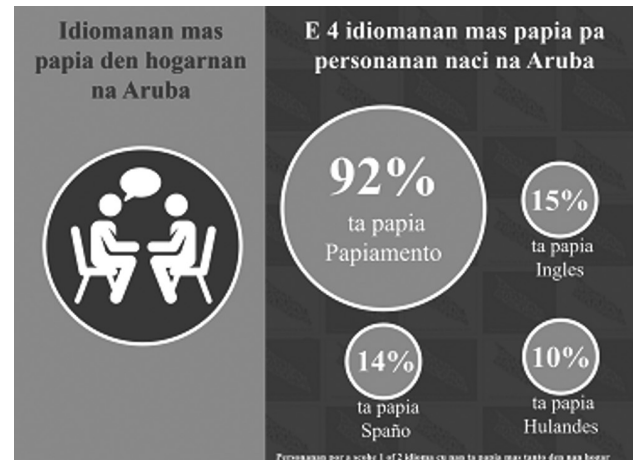

A small chapter in the article ‘Taalonderwijs in Caribisch Nederland’ acknowledges this difficulty regarding the Caribbean’s multilingual society. They give the example of three pupils going to school in Bonaire, Aruba and Curaçao. The pupils in Bonaire and Aruba are six years old and are in grade 3, in which they will begin to learn to read. That reading first happens in the Dutch language, a year later reading in Papiamentu will begin. The article highlights the fact that these children are nervous to read in Dutch; they find that hard, because their mother language is

Papiamento and Dutch is therefore for now an unfamiliar language for them.¹⁸ It could therefore be argued that it is unnatural for children to teach them in a language that is unknown to them.

It is not the case that Papiamento, the mother language of most Aruban students, is absent in the education system, but it is true that this language more functions as a tool instead of the main instruction language. That becomes clear from my class visit; the classroom instruction and directions so that pupils can work independently are in Dutch. When a pupil struggles with the explanation or an assignment, most teachers are willing to explain it again, but then in Papiamento.¹⁹ The student participants of this research acknowledge the fact that their mother language is not Dutch and that Dutch is a language they only speak in school. In their daily life, to express themselves, to talk with friends and family, they use Papiamento or one of the other languages on Aruba, Spanish or English.²⁰ From the class visit at a primary school I did for this research however, it stood out that most pupils were eager to answer questions and tell about their weekend; this is what all classes on this primary school start with on Monday morning.²¹ On the basis of this specific case, it could therefore be argued that Aruban children do not necessarily feel reserved when it comes to speaking up in class, even though that is in the Dutch language.

There are some consequences for students to be taught in Dutch. It happens that students understand the study material less well and/or slower than is desirable.²² This could lead to poorer school results, as the course material is not being absorbed well enough by the students. This is especially unfortunate when you realise that the potential of a pupil might go unseen. It could very well be the case that a student knows a lot about history, chemistry or any other course with regards to the content, but does not perform that well, because of the language barrier. A student participant of this research for instance explains that he is

interested in the course 'chemistry' and knows a lot about it, but he knows the specific chemistry terms in English and Papiamento. The lessons and therefore terms however are in Dutch, which makes it harder for the student to understand the course material, even though he is very interested in the course.²³

The results of being taught in a relatively unknown language, could also be present at the social level. Students might become insecure about their fluency of the Dutch language and are therefore hesitant to give their opinion, engage in a discussion or ask questions. This again could have an impact on the school results of a child, as joining in an interactive lesson could help to absorb the course material. The fact that a child might be hesitant to ask questions, also provides an environment in which the child keeps being stuck with uncertainties about a certain topic and does not learn properly from his or her mistakes.²⁴ A participant of the research declares that his mother language is, unlike the other students, Dutch and that he was therefore more able than other students to speak up in class and also had another kind of relation with the teacher.²⁵ This might prove that the comprehension of the instruction language has an impact on the social skills on a child, at least in class. On the other hand, some people argue that it is valuable that children get taught in their non-mother language as it broadens their interests and their opportunities; it for instance gives students the chance to study in the Netherlands, which is usually perceived as a good place to study and a possibility to increase their chances for career success. The student participants also declare that they feel that Aruban students who study in the Netherlands have a social advantage in comparison with other international students; their language proficiency in Dutch makes it easier to engage in Dutch social life. Other student participants however point out the fact that multiple study programs nowadays are being taught in English, which makes the knowledge of the Dutch language somewhat less relevant and necessary.²⁶

Chapter 2:

The new language advice

It is important to highlight the fact that the new language advice that is being discussed in this paper is a concept version. This version has been established by the ‘Directie Onderwijs’ – a policy and advisory body of the Aruban ministry of education – and is now literally and metaphorically in the hands of the minister of education. This minister views and analyses the advice of the ‘Directie Onderwijs’ and potentially poses some questions and/or comments. After this process, the possibilities are that the advice will be adopted completely, that the advice will be adjusted to a certain extent or that the advice will be rejected.²⁷ For the development of the advice, a participatory process was used, which consisted of an expert group, consultation groups, focus groups, surveys and a national debate.²⁸ The main message of the ‘Directie Onderwijs’ is that Papiamentu should have a more prominent role within the education system. They do however highlight the fact that the multilingual society of Aruba should be taken into account. More specifically, the ‘Directie Onderwijs’ came up with the following recommendations:²⁹

- ‘Formulate target levels for the different languages in education’. This means, realistically looking at the language background of children and see how and to what extent each language can be used within the education system.
- ‘Formulate a continuous learning line for the subject Dutch as a foreign language and one for Papiamentu from pre-school to higher education’. From this it becomes clear that Dutch will henceforth be regarded as foreign language rather than the language of instruction.
- ‘School board draw up a language policy plan for their schools in line with the national guidelines of the integrated language policy’. Schools are thus given a

certain freedom in determining a new language policy, but this must be in line with the national guidelines.

- ‘Use of language subject and language of instruction as support for language development’. Meaning that children will get help with the different languages which will appear in the education system.
- ‘Promoting reading skills and enjoyment of reading’. Reading is essential when it comes to understanding others, understanding course material and it broadens our thinking. It is therefore needed that pupils learn this skills and enjoy doing that.
- ‘Attention for the role of the instruction language vs. the learner’s language skills’. There must be awareness about the balance between the instruction language and the language skills of the student. The student develops skills in the different languages; this can vary from person to person and that should be recognized.
- ‘Continued work to support Papiamentu as a language, subject and language of instruction’. It is needed that more Papiamentu literary works, reference materials (grammar, spelling and terminology), teaching materials and resources will be published.
- ‘Continued work in the support of Dutch as a foreign language’. A change is needed to continue working with the Dutch language; the Dutch language should be seen as a foreign language, instead of the instruction language.

The ‘Directie Onderwijs’ also thought about the needs for a successful implementation of the recommendations of this advice. In their opinion, the following aspects are necessary: providing flexibility for school boards to respond to the specific needs of the different school populations they have at the various schools, developing policies that can find their legal translation in the various legal frameworks, as legislation is a crucial prerequisite for policy implementation, identifying financial implications and recognizing that if funds are not made available structurally, the implementation of the policy will remain

parked. While formulating recommendations, it is crucial that stakeholders see the importance of the proposed changes to existing policies or proposals for new policies.³⁰

Chapter 3:

The possible outcomes of the implementation of the new language advice

The new language policy is meant to support children in their education and make education more suitable for them. This also relates to receptive language skills: listening and reading. These are needed to access knowledge sources. It is important that children come in contact with written sources, because these sources are characterized by more abstract language, more difficult sentence structures and different word usage than spoken language. It is therefore important that the instruction language lend itself for this purpose. A broad objective of quality education is that it enables students and future adults to expand their knowledge beyond the educational curriculum, independently and entirely according to their own choices, necessities and interests. Providing children with access to (unlimited) sources of knowledge is thus a core task of education. Larger linguistic communities such as Dutch, Spanish or English, with many millions of speakers, have many opportunities for development of written (knowledge) resources. This is in contrast to smaller language communities such as Papiamentu with about 250,000 speakers. What is important in creating an educated population is the extent to which people are able to produce knowledge and information resources. In recent decades, the number of Papiamentu-language publications has expanded. It is important that this process keeps going, in order to make Papiamentu a suitable instruction language.³¹

Whether a language has enough publications to shape education well is a question that can hardly be answered.

In essence, determining the exact number of publications is not important. A quantitative approach suggests that one could empirically determine the numbers needed to adequately teach, but science is inconclusive about how many and which books should be read. A broad educational goal, however, especially emphasizes the freedom to make one's own reading choices. This implies that it is not just about the number of publications and not just educationally oriented materials. Free and unrestricted access to humanity's available written resources presupposes above all an enormous variety: in topics, genres, text types and suitability for different age groups.³²

Another important point when changing a part of the education system is the availability of suitable school methods. When the instruction language at schools changes, the methods that are being used for the different courses need to change as well. These methods are currently mostly written in Dutch and therefore do not match with the possible new instruction language, Papiamentu. To match the instruction language with the school methods, new methods written in Papiamentu will need to be developed. Another side note on this, is that certain topics or examples in the current schoolbooks and -methods used in Aruban schools, are usually not very familiar to Aruban students and therefore not suitable for them. Participants of the research indicated that for the course 'geography' for instance, they get taught about rivers. Rivers are very well-known in the Netherlands, but they appear not that much in Aruba. This phenomenon also appears in several other courses, where examples to clarify a certain point or theory, sometimes consist of terms or situations that Aruban students are not familiar with. The disadvantage of this is that these examples are meant to make a certain topic or theory more clear to the student, but in practice the opposite happens; students might get distracted because of the unfamiliar example and therefore do not focus on the actual explanation or assignment. If the school methods would be changed, it

would be good to keep this point in mind and possibly change it to examples that are more applicable to Aruban students.³³

According to Vanessa Scholing-Pietersz a change to Papiamentu as the instruction language in schools could provide better school results because students will understand the material faster, as it is explained to them in their native language. Students might become more confident, dare to speak more when it is in their native language and there would be more appreciation for Papiamentu.³⁴ Despite the fact that the possible switch to Papiamentu will be a real change, Fundation Lanta Papiamentu chairman Eduard Pieters does not see this switch as 'revolutionary'. This may be the case for teachers who have been teaching in Dutch for years and may have had lessons in Dutch themselves, but for students this will probably not feel that intense; they are not used to anything else by the time this plan is implemented and, moreover, they deserve to be taught in their own language.³⁵

Chapter 4:

The Attitude Of Arubans Towards The New Language Advice

In order to implement this possible new language policy, it is important that the Aruban society gets a say in this, because this change might cause some turmoil. And also because many Arubans are involved in education: students, parents and teachers, as well as the fact that school forms the basis on a person's life and is therefore relevant to all Aruban citizens.

Many participants of this research declare that they appreciate the effort that is being done to make Papiamentu more prominent, but they also make the important side note that they believe Papiamentu is not yet ready to take

such a prominent role within the education system. In their opinion, the language has some gaps and first needs to undertake some changes in order to become a standard language. It is now the case that the spelling of Papiamentu somewhat differs within different regions and generations. This is also due to the fact that Papiamentu is currently a language that is mostly being spoken and not so much being written and read. According to the participants, it is important that these differences disappear and that more Papiamentu publications appear, so the language becomes a cohesive whole. They think this is important, because education forms the basis of a person's future and it is useful for this person's next steps, to have a solid basis. Language plays a big role in this and should therefore be clear and consistent. Their opinion is that an insufficient command of Dutch would jeopardize the possibility for a broad knowledge development of young people.³⁶

This ties in to the research of Kibbelaar in which it is said that the reality now is that there are relatively few Papiamentu publications. If young people and adults are only dependent on Papiamentu, they have significantly fewer development opportunities than peers who master a language in which publications are available without restriction. This means that there are fewer opportunities to read frequently and diversely, to make their own reading choices and thereby build interest in reading. Less ability to read results in fewer opportunities to develop reading and other language skills, to build a broad knowledge and rich vocabulary.³⁷ It is therefore important that a possible new language policy for schools not only focuses on Papiamentu, but also takes into account Aruba's multilingual society. This is important for both the emotional and educational aspect. The participants of this research namely highlighted the fact that they are proud of the multiple languages that are being used in Aruba and it could also be valuable for children to get in contact with these different languages; this might broaden their horizons. An important side note here however, is the awareness that a multilingual approach

is not easy to be established, implemented and ultimately put into practice. Schools should be aware of the fact that the mother language of pupils in Aruba differs and that every student therefore comes from a different starting point when it comes to learning and working with a certain language. It might therefore be useful to test the students' fluency and other knowledge of a language and build up from that point.

The students' hesitation towards a shift from Dutch to Papiamentu as the instruction language, also comes from the fact that they are afraid that this switch might be disadvantageous for a student's future. Being taught in Dutch broadens their study and career options, while being taught in Papiamentu might mean a limitation on those options. In addition to this, the student participants say that they did have a bit of a hard time understanding the course material that was being explained to them in Dutch, especially when their teacher was completely Dutch and could not give extra explanation in Papiamentu, but that this was not too difficult for them. They learned the Dutch language through school and were therefore able to take courses in Dutch. It could therefore be the case that these students do not directly see the need for a change in the language policy for schools, because they did manage to complete their Dutch-oriented and Dutch-spoken school time. The students do however declare that their schools treated the Dutch language as it was the first language of their pupils. The schools therefore expected pupils to understand the Dutch language well, which was not always the case and this fact implies that a certain change in the language policy for schools might be useful and appreciated.³⁸

Students also find the Dutch language important, because the language in several official Aruban institutes or other legal matters is Dutch, for instance the judicial system, part of the political system and the signing of contracts. They find it important that they are able to handle these issues at a later stage in their life.³⁹ This ties in to a point Mijts makes

in the publication 'Pluricentric languages in the Americas: the case of Dutch in the Dutch Caribbean', in which it is said that "speakers of Dutch in the Caribbean generally accept Netherlandic Dutch as their norm".⁴⁰ It could therefore be argued that the Dutch language is already too intertwined in the Aruban society, to make the impact of the language less. Another reason for the hesitation of the students, which was acknowledged by 'Directie Onderwijs' employee Vanessa Scholing-Pietersz, is the upcoming of English. This is already one of Aruba's most spoken languages, but has gained more attention through the rise of social media. The rise of social media has provided an environment in which adolescents can easily get in contact with people from other countries. This is especially appealing for the Aruban youth, because living on an island could make them feel isolated. Because of this contact between Aruban young people and young people from mostly the United States of America, Aruban youngsters get influenced by the American way of living, which includes their way of talking; in English. This is why the English language also already takes a more prominent role within the Aruban society, which for Aruban youngsters might reduce the need for the rise of Papiamentu.⁴¹

One of the teachers of a primary school that was interviewed during this research said that she does not immediately agree with a change to Papiamentu as the language of instruction. She indicates that most of her students can cope well with the Dutch language at school. However, she does feel that for Aruban students it is more important than students from other countries to have a certain sense of language and to read a lot.⁴² Another primary school teacher acknowledges that there are some problems with having Dutch as the language of instruction when it is not the mother language of most students. However, she feels that a switch to Papiamentu as the language of instruction is not completely necessary. According to the teacher, this would be too much effort for relatively little result. Indeed, the teacher indicates that the results of elementary

schools that already have Papiamentu as their language of instruction do not necessarily hold better results. In fact, the results are even slightly less well. Therefore, the teacher wants to see more evidence before she would be open to a change to Papiamentu. According to the teacher, it would therefore be more useful to spend money and time on recruiting and using teaching assistants. These assistants could support the teacher by taking apart small groups of students who have difficulties with the Dutch language and/or a particular subject. With this you could also partly solve the problems of Dutch as a language of instruction in Aruban schools, which takes less time, money and effort than a complete change to Papiamentu. Especially since the latter change would also require adapting all school methods. The change proposed by the teacher is, in her opinion, quicker and easier to achieve. The teacher also highlights the fact that Dutch might be useful for pupils, especially in their further education and with legal issues. The teacher therefore thinks it is important to value the Dutch language.⁴³ This ties in to a conclusion of the work of Veronika Wezel, in which she highlighted that teachers feel trapped by the system, the method and the exams. Teachers want the best for their students, but at the same time do not want to let go of the method out of concern for not meeting the standards imposed. For example, the fact that the central exams are in Dutch. They assume that they have to explain the subject matter in full to the Aruban students in order to prepare them properly. As a result, they see no room for interaction in class.⁴⁴

The attitude of Aruban parents was not part of this research, but that is an important aspect of the implementation of a possible new language policy. Joyce Pereira did do research on this specific group. Pereira's conclusion on this was that parents' language background in particular influences their language attitudes. Although they have little information about 'Proyecto Scol Multilingual' – a trial on several Aruban schools in which Papiamentu is the main instruction language - most parents from all language

groups are very positive about educational innovation using Papiamentu as a language of instruction and want their child's school to be included in this project. The only exception here is the Dutch-speaking group. They want Dutch to stay as the instruction language, which is most likely fueled by their own fluency in the Dutch language. What also emerged is that the younger generations of immigrant families embrace Papiamentu as their first or strong second language, meaning that in many families a language shift is taking place in favor of Papiamentu. Also, this research shows that parents are willing to be involved in the educational process and that the 'Directie Onderwijs' can play a dynamic role in creating a platform where parents can be heard.⁴⁵

Chapter 5: The Value Of Papiamentu

The participants of this research explain that Papiamentu is an important aspect of their culture and identity. It is the language they use in their daily life, which among other things consists of being with friends and family, doing groceries and greeting people on the street. It is the language the participants speak automatically and in which they feel most comfortable. The participants also highlight the fact that Papiamentu makes them unique and is a way to talk with their family, without the interference of others.⁴⁶ One of the participants is originally from Colombia and therefore speaks Spanish at home, so for her Papiamentu has an extra layer; she uses the language to engage in the Aruban social life, which is important for her, because she did not completely grow up in Aruba.⁴⁷

Papiamentu is therefore also a tool to create a sense of belonging and solidarity. Because of this emotional influence of Papiamentu that the Aruban participants experience, it might be hard for Arubans to look neutrally at the possible change in the language policy for schools.

The organisation 'Fundacion Lanta Papiamentu' (FLP) tries to improve the status of Papiamentu. An activity in which they do that, is several lectures in which they give attention to writers. This point ties in to a earlier statement in which it was being said that not many Papiamentu publications have been published and that a rise of these publications might strengthen the possibility of success for the implementation of Papiamentu as the instruction language. These lectures are available for all interested people and thus constitute a certain approachability that can make Papiamentu more visible. Although the chairman of FLP, Eduard Pieters, appreciates the interest in those kind of activities, he is worried about the public that is present at those activities. This public namely consists of few young people and Pieters highlights the fact that young people are the future. In order to keep valuing Papiamentu and make the language sustainable, it is needed that Papiamentu will be passed on to the next generations and that these generations see the value of their language.⁴⁸

This issue could therefore also be seen as a competition between two sustainability issues; preserving Papiamentu as part of the Aruban culture and identity and making sure children receive 'inclusive and equitable quality education'. In practice, it is visible that these aspects are difficult to combine properly. Pieters sees the value of Papiamentu as a fight that needs to keep going and also sees the effort other Arubans put into this. However, he also highlights the fact that the value of Papiamentu needs to be seen everyday, not just on celebrations like the international day of the mother language. It is therefore important that the Aruban society, the Aruban government and the Papiamentu language stay a whole, in order to value Papiamentu, letting the language develop itself and making it sustainable.⁴⁹

Conclusion

The discussion on which instruction language should be used on Aruban schools is an centuries-old discussion

and still continues. It is argued that the issue of having Dutch as the instruction language is that Dutch is not the mother language of Aruban children, which could be seen as unnatural and unnecessarily difficult for them. Pupils might feel insecure when speaking up in class and it does not benefit their school results. A new language policy for schools could possibly, at least partly, solve this issue.

The main goal of this research was therefore to research the reactions from different sort of groups to the possibility of a new language policy for schools in which Papiamentu would have a more prominent role than it has now. The reaction of the teachers in this research was somewhat reserved, because they see both advantages and disadvantages of this change. Their final judgement however, is that a change to Papiamentu as the instruction language is not necessarily the best solution for the issues that some children experience with Dutch as the language of instruction. This is due to the fact that this change will cost a lot of time, money and effort, and because they value the Dutch language with regards to legal issues and further education and they think it is important to keep doing that. They recognize the fact that Papiamentu forms an big part of the Aruban culture and identity and that it is important to pay attention to the sustainability of Papiamentu, but they think that Dutch is more suitable for the education.

The student participants of this research agree with this final judgement. What they added to the previous things being noted, is the upcoming of the English language. Both through social media and studies that are being taught in English, the need for education in Papiamentu reduces. The student participants of this research do not directly see the need for a change in the instruction language at schools; they appreciate the Dutch language because of its usability for the future: study, career and legal aspects. An additional fact in this is that multiple studies are currently being taught in English which could create an environment in which both Dutch and Papiamentu will become less relevant.

Papiamentu therefore has competition from English, which makes it harder to take on a more prominent role. The students notice that the fact that Papiamentu does not have that many publications, is also a struggle to become the instruction language. They do however highlight the fact that Papiamentu is important for the Aruban culture and community. The general attitude of the Aruban participants of this research towards the new language can therefore be summarized as hesitant, including both advantages and disadvantages of the plan.

It must be said that this research is small-scaled and it is therefore not possible to make general assumptions. In conclusion of this research however, it can be said that the consideration of implementing Papiamentu into the Aruban education system and therefore reducing the Dutch language, is a fight between the head and the heart. The heads of Arubans say that the Dutch language is important for the development and future of their children and that Papiamentu is not yet ready to take a prominent role within the education. Their hearts however say that Papiamentu form an important aspect of their culture and identity and should therefore also be valued and cherished in schools.

The question of whether it is better to set up Papiamentu-speaking or Dutch-speaking education also has to do with the ambitions that Aruba wants to pursue with their education. What exactly would it be better for? What goal do they want to achieve with education? The main question in this matter is whether one considers it important that Papiamentu-speaking children have the opportunity to read about diverse and self-chosen subjects and thus expand their knowledge and skills. Is it the aim that Papiamentu-speaking children get the same development opportunities as other speaking peers on the islands and elsewhere in the world, who do master a language in which knowledge is available without limitation? This is an ethical question that touches on fundamental values such as freedom, equality and equal opportunities. These might be questions that are useful

for follow-up research, looking at what Aruba wants and needs regarding education and looking at the possibilities. The possible implementation of this new language policy, if approved by the Aruban minister of education, will most likely take several more years. Whatever decision is made about language policy in schools, it is important to keep the best interests of the children in mind and remember that they have a right to have "inclusive and equitable quality education and promote lifelong learning opportunities for all", as promised by the United Nations.

Endnotes

1. Manuela Julien, 'TOS kan ook voorkomen bij meertalige kinderen, maar niet vaker dan bij eentalige kinderen!' (23 oktober 2020), <https://www.clinicababilonica.eu/tos-kan-ook-voorkomen-bij-meertalige-kinderen-maar-niet-vaker-dan-bij-eentalige-kinderen/> (29 March 2023).
2. Departement onderwijs Aruba, 'Integraal Taalbeleid Onderwijs 2022: Voorlopige conclusie en aanbevelingen' (2022). (Concept version).
3. United Nations, 'Sustainable Development Goal 4', <https://sdgs.un.org/goals/goal4> (24 March 2023).
4. Joyce Pereira, 'Valorization of Papiamento in Aruban society and education, in historical, contemporary and future perspectives' [dissertation University of Curaçao] (2018).
5. Eric Mijts, 'Op de Antillen en Aruba is Nederlands een vreemde taal', *Ons Erfdeel* 51 (2008).
6. Gert Oostindie en Alex van Stipriaan, 'Inleiding: Antiliaans erfgoed, natievorming, nation branding', in: Gert. Oostindie, & Alex van Stipriaan, *Antilliaans erfgoed I; Toen en nu* (Leiden 2021) 1-21.
7. J. Kibbelaar, 'Onderwijs op de ABC-eilanden: Focus op kennisontwikkeling', *Levende Talen Magazine* 6 (2019) 24-29, there 26.
8. Aruba.com, 'Papiamento en Nederlands: De officiële talen van Aruba', <https://www.aruba.com/nl/ons-eiland/aruba-de-feiten/taal> (28 March 2023).
9. Gert Oostindie en Alex van Stipriaan, 'Inleiding: Antiliaans erfgoed, natievorming, nation branding', in: Gert. Oostindie, & Alex van Stipriaan, *Antilliaans erfgoed I; Toen en nu* (Leiden 2021) 1-21, there 1.
10. Gert Oostindie, 'Taal, geschiedenis en Antiliaanse identiteiten', in: Henny E. Coomans, Maritza Coomans-Eustatia & Peter Prins et al, *Caraïbische cadens; Liber amicorum* (1995) 148-153, there 148.
11. Aruba.com, 'Papiamento en Nederlands: De officiële talen van Aruba', <https://www.aruba.com/nl/ons-eiland/aruba-de-feiten/taal> (28 March 2023).
12. Eric Mijts, 'Op de Antillen en Aruba is Nederlands een vreemde taal', *Ons Erfdeel* 51 (2008), 94.
13. Vanessa Scholing-Pietersz (employee 'Directie Onderwijs'). Interview by Thijn Fruijtier, 9 March 2023, Oranjestad, Aruba. Recording <https://drive.google.com/drive/folders/1fVPU1M8pnk62yU9CxlExBO8DQVIXdyh>.
14. Vanessa Scholing-Pietersz (employee 'Directie Onderwijs'). Interview by Thijn Fruijtier, 9 March 2023, Oranjestad, Aruba. Recording <https://drive.google.com/drive/folders/1-fVPU1M8pnk62yU9CxlExBO8DQVIXdyh>.
15. Ana Castellón, Jeanmichel Kelly, Wenny Li and Chris Solognier (students). Interview by Thijn Fruijtier, 10 March 2023, Oranjestad, Aruba. Recording <https://drive.google.com/drive/folders/1-fVPU1M8pnk62yU9CXIExBO8DQVIXdyh>.
16. Anonymous school. Class visit by Thijn Fruijtier, 27 March 2023, Oranjestad, Aruba.
17. Department of Education Aruba, 'According to the Pilot Census, Papiamento is the most used language at home' (version October 2019), https://www.government.aw/news/news_47033/item/according-to-the-pilot-census-papiamento-is-the-most-used-language-at-home_54889.html (9 May 2023).
18. Ludo Verhoeven, Eliane Segers, Ronald Severing, et al., 'Taalonderwijs in Caribisch Nederland', *Didactief Special* 53 (2023) 3, 1-12, there 3.
19. Anonymous school. Class visit by Thijn Fruijtier, 27 March 2023, Oranjestad, Aruba.
20. Ana Castellón, Jeanmichel Kelly, Wenny Li and Chris Solognier (students). Interview by Thijn Fruijtier, 10 March 2023, Oranjestad, Aruba. Recording <https://drive.google.com/drive/folders/1-fVPU1M8pnk62yU9CXIExBO8DQVIXdyh>.
21. Anonymous school. Class visit by Thijn Fruijtier, 27 March 2023, Oranjestad, Aruba.
22. Anonymous teacher 1. Interview by Thijn Fruijtier, 27

- March 2023, Oranjestad, Aruba.
23. Jeanmichel Kelly (student). Interview by Thijn Fruijtier, 10 March 2023, Oranjestad, Aruba. Recording <https://drive.google.com/drive/folders/1-fVPU1M8pnk62yU9CXlExBO8DQVIXdyh>.
 24. Anonymous teacher 1. Interview by Thijn Fruijtier, 27 March 2023, Oranjestad, Aruba.
 25. Chris Solognier (student). Interview by Thijn Fruijtier, 10 March 2023, Oranjestad, Aruba. Recording <https://drive.google.com/drive/folders/1-fVPU1M8pnk62yU9CXlExBO8DQVIXdyh>.
 26. Ana Castellón, Jeanmichel Kelly, Wenny Li and Chris Solognier (students). Interview by Thijn Fruijtier, 10 March 2023, Oranjestad, Aruba. Recording <https://drive.google.com/drive/folders/1-fVPU1M8pnk62yU9CXlExBO8DQVIXdyh>.
 27. Vanessa Scholing-Pietersz (employee 'Directie Onderwijs'). Interview by Thijn Fruijtier, 9 March 2023, Oranjestad, Aruba. Recording <https://drive.google.com/drive/folders/1-fVPU1M8pnk62yU9CXlExBO8DQVIXdyh>.
 28. Departement of Education Aruba, 'Integraal Taalbeleid in het Onderwijs: powerpoint' (October 2022).
 29. Department of Education Aruba, 'Integraal Taalbeleid Onderwijs 2022: Voorlopige conclusie en aanbevelingen' (2022). (Concept versie) 1-46, there 21-22.
 30. Department of Education Aruba, 'Integraal Taalbeleid Onderwijs 2022: Voorlopige conclusie en aanbevelingen' (2022). (Concept versie) 1-46, there 21-22.
 31. J. Kibbelaar, 'Onderwijs op de ABC-eilanden: Focus op kennisontwikkeling', *Levende Talen Magazine* 6 (2019) 24-29, there 26-27.
 32. J. Kibbelaar, 'Onderwijs op de ABC-eilanden: Focus op kennisontwikkeling', *Levende Talen Magazine* 6 (2019) 24-29, there 27-28.
 33. Anonymous teacher 1. Interview by Thijn Fruijtier, 27 March 2023, Oranjestad, Aruba.
 34. Vanessa Scholing-Pietersz (employee 'Directie Onderwijs'). Interview by Thijn Fruijtier, 9 March 2023, Oranjestad, Aruba. Recording <https://drive.google.com/drive/folders/1-fVPU1M8pnk62yU9CXlExBO8DQVIXdyh>.
 35. Eduard Pieters (chairman Funcation Lanta Papiamento). Interview by Thijn Fruijtier, 28 February 2023, Oranjestad, Aruba. Recording <https://drive.google.com/drive/folders/1-fVPU1M8pnk62yU9CXlExBO8DQVIXdyh>.
 36. Ana Castellón, Jeanmichel Kelly, Wenny Li and Chris Solognier (students). Interview by Thijn Fruijtier, 10 March 2023, Oranjestad, Aruba. Recording <https://drive.google.com/drive/folders/1-fVPU1M8pnk62yU9CXlExBO8DQVIXdyh>.
 37. J. Kibbelaar, 'Onderwijs op de ABC-eilanden: Focus op kennisontwikkeling', *Levende Talen Magazine* 6 (2019) 24-29, there 28.
 38. Ana Castellón, Jeanmichel Kelly, Wenny Li and Chris Solognier (students). Interview by Thijn Fruijtier, 10 March 2023, Oranjestad, Aruba. Recording <https://drive.google.com/drive/folders/1-fVPU1M8pnk62yU9CXlExBO8DQVIXdyh>.
 39. Ana Castellón, Jeanmichel Kelly, Wenny Li and Chris Solognier (students). Interview by Thijn Fruijtier, 10 March 2023, Oranjestad, Aruba. Recording <https://drive.google.com/drive/folders/1-fVPU1M8pnk62yU9CXlExBO8DQVIXdyh>.
 40. Eric Mijts, 'Pluricentric languages in the Americas: the case of Dutch in the Dutch Caribbean', in: Rudolf Muhr, Eugenia Duarte, Cilene Rodrigues, Juan Thomas, et al, *Pluricentric languages in the Americas* (2022) 231-244, there 231.
 41. Vanessa Scholing Pieters (employee 'Directie Onderwijs'). Interview by Thijn Fruijtier, 9 March 2023, Oranjestad, Aruba. Recording <https://drive.google.com/drive/folders/1-fVPU1M8pnk62yU9CXlExBO8DQVIXdyh>.
 42. Anonymous teacher 2. Interview by Thijn Fruijtier, 27 March 2023, Oranjestad, Aruba.
 43. Anonymous teacher 1. Interview by Thijn Fruijtier, 27

March 2023, Oranjestad, Aruba.

44. Veronika Wenzel, 'Het Nederlands in het voortgezet onderwijs in Aruba: Een onderzoek naar de behoeften en attitudes van docenten 2021/2022', *Aruba: Bibliotheca Nacional Aruba* (2022) 1-106, there 81.
45. Joyce Pereira, 'Valorization of Papiamentu in Aruban society and education, in historical, contemporary and future perspectives' [dissertation University of Curaçao] (2018), 197.
46. Ana Castellón, Jeanmichel Kelly, Wenny Li and Chris Solognier (students). Interview by Thijn Fruijtier, 10 March 2023, Oranjestad, Aruba. Recording <https://drive.google.com/drive/folders/1-fVPU1M8pnk62yU9CXlExBO8DQVIXdyh>.
47. Ana Castellón (student). Interview by Thijn Fruijtier, 10 March 2023, Oranjestad, Aruba. Recording <https://drive.google.com/drive/folders/1-fVPU1M8pnk62yU9CXlExBO8DQVIXdyh>.
48. Eduard Pieters (chairman Funcation Lanta Papiamentu). Interview by Thijn Fruijtier, 28 February 2023, Oranjestad, Aruba. Recording <https://drive.google.com/drive/folders/1-fVPU1M8pnk62yU9CxlExBO8DQVIXdyh>.
49. Eduard Pieters (chairman Funcation Lanta Papiamentu). Interview by Thijn Fruijtier, 28 February 2023, Oranjestad, Aruba. Recording <https://drive.google.com/drive/folders/1-fVPU1M8pnk62yU9CxlExBO8DQVIXdyh>.

Bibliography

- Anonymous school. Class visit by Thijn Fruijtier, 27 March 2023, Oranjestad, Aruba.
- Anymous teacher 1. Interview by Thijn Fruijtier, 27 March 2023, Oranjestad, Aruba.
- Anonymous teacher 2. Interview by Thijn Fruijtier, 27 March 2023, Oranjestad, Aruba.
- Aruba.com, 'Papiamentu en Nederlands: De officiële talen van Aruba', <https://www.aruba.com/nl/ons-eiland/aruba-de-feiten/taal> (28 march 2023).
- Castellón, Ana (student). Interview by Thijn Fruijtier, 10 March 2023, Oranjestad, Aruba. Recording <https://drive.google.com/drive/folders/1-fVPU1M8pnk62yU9CXlExBO8DQVIXdyh>.
- Department of Education Aruba, 'Integraal Taalbeleid in het Onderwijs: powerpoint' (October 2022).
- Department of Education Aruba, 'According to the Pilot Census, Papiamentu is the most used language at home' (version October 2019), https://www.government.aw/news/news_47033/item/according-to-the-pilot-census-papiamentu-is-the-most-used-language-at-home_54889.html (9 May 2023).
- Department of Education Aruba, 'Integraal Taalbeleid Onderwijs 2022: Voorlopige conclusie en aanbevelingen' (2022). (Concept version) 1-46.
- Julien, Manuela, 'TOS kan ook voorkomen bij meertalige kinderen, maar niet vaker dan bij eentalige kinderen!' (23 october 2020), <https://www.clinicababilonica.eu/tos-kan-ook-voorkomen-bij-meertalige-kinderen-maar-niet-vaker-dan-bij-eentalige-kinderen/> (29 March 2023).
- Kelly, Jeanmichel (student). Interview by Thijn Fruijtier, 10 March 2023, Oranjestad, Aruba. Recording <https://drive.google.com/drive/folders/1-fVPU1M8pnk62yU9CxlExBO8DQVIXdyh>.
- Kibbelaar, J., 'Onderwijs op de ABC-eilanden: Focus op kennisontwikkeling', *Levende Talen Magazine* 6 (2019).
- Li, Wenny (student). Interview by Thijn Fruijtier, 10

- March 2023, Oranjestad, Aruba. Recording <https://drive.google.com/drive/folders/1-fVPU1M8pnk62yU9CxlExBO8DQVIXdyh>.
- Mijts, Eric. 'Op de Antillen en Aruba is Nederlands een vreemde taal', *Ons Erfdeel* 51 (2008).
 - Mijts, Eric, 'Pluricentric languages in the Americas: the case of Dutch in the Dutch Caribbean', in: Rudolf Muhr, Eugenia Duarte, Cilene Rodrigues, Juan Thomas, et al, *Pluricentric languages in the Americas* (2022) 231- 244.
 - NRC Nieuws, 'Stop op Aruba met examens in het Nederlands' (11 may 2018), <https://www.nrc.nl/nieuws/2018/05/11/stop-op-aruba-met-examens-in-het-nederlands-a1602653> (28 March 2023).
 - Oostindie, Gert en Alex van Stipriaan, 'Inleiding: Antiliaans erfgoed, natievorming, nation branding', in: Gert. Oostindie, & Alex van Stipriaan, *Antilliaans erfgoed I; Toen en nu* (Leiden 2021) 1-21.
 - Oostindie, Gert, 'Taal, geschiedenis en Antiliaanse identiteiten', in: Henny E. Coomans, Maritza Coomans-Eustatia & Peter Prins et al, *Caraïbische cadens; Liber amicorum* (1995) 148-153.
 - Pereira, Joyce, 'Valorization of Papiamentu in Aruban society and education, in historical, contemporary and future perspectives' [dissertation University of Curaçao] (2018).
 - Pieters, Eduard (chairman Funcation Lanta Papiamentu). Interview by Thijn Fruijtier, 28 February 2023, Oranjestad, Aruba. Recording <https://drive.google.com/drive/folders/1-fVPU1M8pnk62yU9CxlExBO8DQVIXdyh>.
 - Scholing-Pietersz, Vanessa (employee 'Directie Onderwijs'). Interview by Thijn Fruijtier, 9 March 2023, Oranjestad, Aruba. Recording <https://drive.google.com/drive/folders/1-fVPU1M8pnk62yU9CxlExBO8DQVIXdyh>.
 - Solognier, Chris (student). Interview by Thijn Fruijtier, 10 March 2023, Oranjestad, Aruba. Recording <https://drive.google.com/drive/folders/1-fVPU1M8pnk62yU9CxlExBO8DQVIXdyh>.
 - United Nations, 'Sustainable Development Goal 4', <https://sdgs.un.org/goals/goal4> (24 March 2023).
 - Verhoeven, Ludo, Eliane Segers, Ronald Severing, et al., 'Taalonderwijs in Caribisch Nederland', *Didactief Special* 53 (2023) 3, 1-12.
 - Wenzel, Veronika, 'Het Nederlands in het voortgezet onderwijs in Aruba: Een onderzoek naar de behoeften en attitudes van docenten 2021/2022', Aruba: *Bibliotheca Nacional Aruba* (2022) 1-106.



İmre İşmen, University College Utrecht

...what are the stories that come out of it all...

I think the most important lesson I learned in Aruba was how the luckiest part of me was the fact that I want to move back home, the fact that I can want to move back home. I wanted to ask around in Aruba about migration because in ways it amazed me; how people move from place to place, how Aruba is as a host country, what are the stories that come out of it all...

They were all questions I have been asking myself for a while, in different countries for different circumstances and I am very glad I had a chance to learn from Aruba.

It was refreshing to research about immigration in a place where autochthony is defined through blurred lines and through languages and songs. I wanted to go around and just ask everyone their thoughts and experiences. Of course it made it so much easier that people oftentimes wanted to talk as well. I want to specifically thank everyone who

helped me through my research project; I want to thank Luc Alofs for guiding me through the conception part of my research and helping me reach out to schools, and also Keisy and Kay-Linn for helping me research, translating documents and helping me transcribe all the interviews. Without them I wouldn't have reached my respondents.

I also want to thank all of my respondents for sharing their experiences with me. After transcribing the texts, analyzing them, I want to say how lucky I felt for knowing a part of their story and being curious about their futures.

For me Aruba was not the easiest place to live in, mainly because I couldn't move around the island as much as I had hoped for. On the bright side, I will get a driving license after this experience. I would like to have more freedom exploring the island but it can always be the next time. I made beautiful friends in Aruba and had the chance

to witness their lives. Our late night conversations, and brunches will be dearly missed.

I want to specifically thank my friend Jasmine, for being there to discuss how to actually write a research paper and all the existential dread that can come with it. I want

to thank Eric, for creating room for my mess and chaos and mentoring me through the process. His support and acceptance made the paper possible. I want to thank Jocelyn for organizing this project with Eric and finally I want to thank my thesis supervisor Markha for her guidance.



Through Relation; Sense of Belonging for Young Migrants in Aruba

İmre İşmen

1. Introduction

Aruba is a country within the Kingdom of Netherlands, a beautiful island state off the coast of Venezuela, filled with amazing people and a thriving culture. There are multiple reasons to claim that Aruba is such a special place to study migration. Firstly, as a small island, the first inhabitants Caiquetio Arawak people, came from Venezuela in 850 BCE (Coelho, 2023). Migration has been a part of Aruba from the start and thus has been shaping its make up and forming its culture. Secondly, throughout the history of the island, migration was an integral part of how the island's demography and economy were formed. Indeed so, an overwhelming majority of the island has some form of migrant background in their ancestry, making Aruba an intensely multicultural place. The official reports state that Aruba has a population of 108.166, with 39.903 of them being migrants, making Aruba one of the countries with the most migrants in relation to its population (*Quarterly Demographic Bulletin 2022*, 2022). Although, since the industrialization of the island the proportion of migrants within Aruba has been high, the current situation seems to be grounds for concern. The growth of the tourism sector in Aruba and global events in surrounding countries, notably the political and economic crisis in Venezuela, has brought the situation to what it is right now. The sheer number of migrants has started causing dissent within the island community. Although the people of Aruba are

generally very open-minded and accepting of what is new and different, there is also a growing xenophobic sentiment, especially towards Latin migrants. The questions of who has a right to arrive to Aruba; and once they are here, who can or should stay are some of the first things mentioned when migration is being talked about. These question essentially boils down to who belongs here, or who can belong here?

Belonging is a fundamental need and a purpose every human shares. Belonging, or the desire to do so, in some form of rootedness, familiarity, comfort, and acceptance shapes the foundations of our communities. As social beings, humans are dependent on communities. Belonging is one of the important components of emotional and psychological well-being. Belonging is also a difficult state to achieve or even to dream of for some. Furthermore, it is an incredibly interesting topic, touching the most intimate parts of ourselves and our lives while not being restricted by any physical border. People belong to online communities, people belong to other people, to songs and food... When it comes to adolescents and young adults, belonging entails their attempts of finding a place for themselves within this world. When it comes to migrants, belonging is a major challenge.

For this research, my aim is to answer the following question: How are the different senses of 'belonging' experienced, negotiated and understood by young migrants in Aruba?

What are the different factors affecting the processes of young migrants forming their belonging? I approach migration as a social phenomenon that introduces a new set of experiences to the individual. Mobility and change are interconnected, and they both hold great space within our daily lives as well as the projections of our world (Youhkhana, 2015). Migration is the experience of both mobility and change simultaneously, while societal and economic factors are continuously pulling and pushing at it. Within our current system composed of nation-states, migration becomes the process of both gaining and losing rights. Although in its barest form the word migration just denotes the movement of people from a place to another, which is the definition that will be used for this paper, it marks the movement of more than just people, but of ideas, dialects, languages and much more. Furthermore, migrants do not only carry their nationalities with them but also their dreams, experiences, and sometimes even families. They all have their unique experience of moving, and a variety of different factors forming said experiences. For this research, I asked young migrants what their personal experiences were, and which factors had an effect. This qualitative research adopts an interpretivist approach, which aims to understand and share the thoughts and feelings of the respondents. Belonging, as a construct, has the potential of offering an analytical framework that incorporates multiplicities alongside change, while simultaneously symbolizing safety and acceptance.

2. Literature Review

2.1 Belonging

One of the main reasons 'belonging' is such a widely used social construct is how it is experienced by everyone, yet in its own unique and ever-changing ways. People's belonging can relate to a whole array of objects that carry emotional meaning, and it can transpire in a whole range of ways (Yuval-Davis, p199, 2006). Furthermore, although it is experienced individually, it can never be separated

from the collective, as such it is always in the process of being negotiated, updated and revised. It "...can be an act of self-identification or identification by others, in a stable, contested or transient way" (Yuval-Davis, p199, 2006). Belonging carries the importance of 'mundane' parts of living, as attachment forms to habits, places and objects (Jones et al., 2011). Consequently, it provides room for understanding the attachments towards foods, accents etc. making it "...possible to include sentimental, cultural and symbolic dimensions" (Jones, p43, 2011).

Belonging has been one of the key concepts that informed and inspired social science fields like sociology and psychology (Yuval-Davis, 2006). Although it has widely affected said fields, when it comes to defining it as a construct and using it, contestations exist. Yuval-Davis divides belonging into three interconnected parts; social locations, individuals' identification and ethical and political value systems (2006). These levels can not be fully separated from one another and used exclusively to assess 'belonging' for doing so will lead to reductivist analogies, still, their unique contributions should be acknowledged and valued individually.

2.2 Belonging and Integration

Jardim and Silva carried out qualitative research in Portugal with young Ukrainian, Romanian and Afro-descendants on their sense of belonging with regards to Portugal and their parent's origin country (2021). They concluded that "social class, race, cultural and civic practices, social interactions, aesthetic appreciation of public spaces and cultures, as well as historical and political interests play a significant role in the formation of young people's belonging" and suggested that this information could be useful for states' programmes on assisting the youth's integration to Portugal (Jardim et al., p240, 2021).

2.3 Belonging and Identity

The integrationist and assimilationist approaches work

and affect policy making through an assumption of homogeneity, when it comes to the local population as well as to 'migrants'. Migrants are continuously referred to as a "coherent" and "internally consistent group", which aids the division of 'us' versus 'them' and completely disregards other aspects of migrants' positionalities that differentiate them (Jones et al., p 42, 2011). Jones explains this as one of the many issues of 'identity' in social sciences, stating that it could have been a useful construct had it not been handled in such an overarching explanatory framework" (Jones et al., p38, 2011). Their suggestion is to introduce 'belonging' and through the relationship of belonging and identity reach a much more hybrid, changeable construct that aids empirical research (Jones et al, 2011).

The relationship between belonging and identity has always been intimate, so much so that these words have been previously used interchangeably in social sciences (Youkhana, 2015). However, Jones explains the relationship between belonging and identity as;

- Vitaly then, belonging can be considered a process whereby an individual in some way feels some sense of association with a group, and as such represents a way to explain the relationship between a personalized identity and a collective one. In a purely conceptual way belonging is about the relationship between personal identity and a collective identity – there is something about one's personal belonging that is comparable to one's perception of the aims, constitution or values of a given collective (p 42, 2011)

Here, Jones handles belonging as it relates to collectives, and states that through analyzing belonging some of the misconceptions attributed to identity can be precluded. Most of these misconceptions are with regards to the differentiation placed between the 'self' and the 'other'. Jones argues that belonging and associations are formulated through the relations with the 'other', these relations can lead to belongings as well (2011).

In this sense, belonging does not have to be derived from a 'sameness' or a homogeneity but instead evolves from a 'fleeting solidarity', demonstrating the flexible nature of belonging even further (Jones et al., p46, 2011). Giving an example from Hesse's work, Jones suggest that this form of reading of belonging demonstrates that "as collective identities are often strengthened by dislocation from their (geographical) place of origin, with diasporic communities frequently reinterpreting or even reinventing national traditions in a new social setting" (2000, taken from Jones et al, p46, 2011). This opens a new opportunity for research when it comes to migrants' experience of belonging and identity.

2.4 Belonging, Home and Identity

As emotional attachments gained importance in people's understanding of both belonging and identity, one of the concepts that appeared in research was 'home'. Being at 'home' has even been used as a "superficial" definition of belonging (Jones et al, p41, 2011/ Yuval-Davis, p197, 2006). As such the relationship between belongings, identity and what people construed as 'home' becomes interrelated, it opens the door for another important aspect of belonging; place. Belonging as a sentiment, or even culture towards a collective has been discussed. However, belongings can also have material articulations such as 'home'. Home is never an easy concept to define and it can become even more complicated for migrants and people with migrant backgrounds, as they "...continue to load new meanings onto it centered on family, social relations, and emotional attachment and investment" (Liu, p24, 2014). Literature suggests that 'home' has strong associations with family and familial relations, as well as having an important material aspect to it. Liu theorizes that as the emotional ties and attachments materialize in a place or a setting 'home' takes form, and suggests the importance of the both physical and emotional aspects of its presence (p24, 2014). Liu further states that this construction of home is intimately connected with the ways migrants experience belonging

and negotiate their identities, tying all the concepts back together (p24, 2014). Home can not be understood without its physical components, it connotes a 'place' or a 'space'. Associating themselves with the beautiful sceneries of their host country affects the experience of belonging for migrants (Jardim et al., 2021). Existing within a place and how that place is experienced, has a strong influence on the sense of belonging for everyone, including migrants.

2.5 Belonging and Place

There have been other ways of conceptualizing the material and physical aspect of belonging that does not necessarily focus on the notion of 'home'. Youkhana draws on the work of Anthias on translocality, which aims to understand the structural factors that affect belonging, without denying the person's agency or personal histories, which utilizes space, abstaining from using it as a boundary (Anthias, 2010, 2015).

Youkhana discusses the ways "space" can be introduced as an analytical category to further understand belonging as a concept, as a way of combining the material and the social (2015). They aim at analyzing the relevance of space for the construction and performance of belonging. They focus on how public space could be used for acts of resistance through employment of art and creativity. This research handles a novel approach to space and thus belonging as they argue the collective and the individuals taking action for their belonging to a space, and thus taking part in the creation of new belongings. This research demonstrates how belonging is a construed concept, and how this construction can take different forms, in relation to others and space.

3. Contextual Background

Migration is spatial as it is influenced by socio-economic, political, religious and cultural factors. On top of that the cultural and social make-up, the history of the host community, and the host community's previous relations

with the migrants origin country influence how it is understood, regulated and experienced. When it comes to Aruba, most of what a Western European audience would presuppose on migration starts to become blurry, and loses meaning. Aruba's colonial history, coupled with the rapid industrialization the island went through within the 20th century creates a creolized community. The history of Aruba carries influence from a variety of cultures, which includes but is not limited to; its former colonizers, the Netherlands, the country of most of its tourists the U.S., to the surrounding countries and islands that brought both Caribbean and Latin American customs and traditions. I would like to provide a brief overview of some of the histories that may have played a part in shaping the respondents' experiences.

The oil refinery that opened in Aruba in 1929 brought wealth and job opportunities to the Island, although its effects were not felt by the locals instantaneously. Due to the company being an American company that required skilled labor, the refinery looked to surrounding countries to fill up its positions. Over the years the locals benefited¹ economically from its effect. The industrialization of the island brought labor migrants.

Later on with the tourism sectors beaming up, there was even more need for labor, which brought more people in. Migration being a constant, from various places, due to industrialization, affected culture formation and identity. As migration between the islands was widespread, the identity of Arubans and how it differed from others became an interesting topic. Luc Alof and Leontine Merckies wrote a book titled *Ken Ta Arubiano? (Who is Aruban?)* to address this topic. For although, as the results and the discussion will make it obvious, there is a perceived difference between those who are Aruban and those who came afterwards, Arubans' definition of autochthonous is hugely different than say a Western European's definition. The majority of the island's population has some form of a migrant background, the

origin of being Aruban is mainly dependent on birthplace, most of the second generation migrants know and speak Papiamentu and refer to themselves and are referred to as Arubans.

Another global event that affected the Island is the political and economic crisis in Venezuela. As Venezuelans flee the system that endangers their lives and well beings, a widespread refugee crisis emerged in Latin America. When it comes to Aruba, there has been an influx of Venezuelan refugees to the country since 2017, their unique experiences have been researched and documented by Hanna Mayr for a previous year's UAUCU research book (2020). Venezuelan refugees are being denied "refugee" status and thus being made "illegal" by the Aruban government (Mayr, 2020). Since last year, 1/6th of the island population was composed of Venezuelan refugees, most of whom were undocumented. This resulted in a growth of negative stereotypes toward Venezuelan migrants and affected the views of locals. Although not everyone shares these beliefs, as my respondents' experiences will demonstrate, it affects Latin American migrants and their experiences.

4. Theoretical Framework

For this research, an interpretivist approach will be used, to understand and express the experiences of my respondents as closely to their life as possible (Chowdhury 2014). Interpretivist approach entails an understanding of the social world through the ways it is lived by people. The interpretivist approach aims to understand rather than provide casualties, to demonstrate the unique experiences rather than generalize, and to share the realities of the respondents rather than draw conclusions. There are structural and material reasons behind the experiences of all of my respondents, just as it is the case for everyone else. My aim with the interpretivist approach is not to deny the socio-political circumstances that shape my respondents' experiences but to accept that with the current data at

hand I can not offer any generalizable conclusions. Instead, this research's aim is to give an overview of some of the ways belonging is experienced by young migrants within Aruba. The insights of this research can hopefully lead to the audience gaining a better understanding, and for researchers to have a starting point.

Another reason I chose to follow the interpretivist approach is because belonging and how it is experienced is incredibly subjective, although there have been clear patterns within some of my respondents' answers, there have also been considerable differences that I can only attribute to how the island and migration has been experienced by my respondents. Through this research I wanted to abstain from making overarching statements on what my respondents have shared with me because doing so would require me to connect them to factors they themselves did not mention. My aspiration has been to only reflect upon what they themselves deemed important, and decided to share. Although it is impossible for this research to be objective research, as it is people I ask my questions to, and it is a person² who wrote and asked said questions, I want to proceed through accepting this limitation and trying my best to display their experiences of belonging.

5. Methodology

5.1 Data Collection and Research Design

This research will aim to answer what are the different factors affecting young migrants' sense of belonging, after they migrated to Aruba. For this research, belonging will not be conceptualized only in regard to the host country, but also will aim to understand how they articulate what "belonging" means for them, and its effects in their lives. The research design for this project was semi-structured interviews that lasted approximately 45 minutes with each respondent, alongside with 2 focus group discussion, both of which lasted slightly over an hour. The method of semi-structured interviews was chosen, as it provided

the opportunity for an in-depth conversation about their experiences that could be changed and arranged for their personal lives, as most of my respondents had different experiences. For the interviews open ended questions were used. The decision of adding focus groups was to ensure the comfort of my respondents as well as for an ease of time arrangement, as the focus groups took time during my respondents' school hours. Focus groups also created the room for my respondents to interact with one another and share their thoughts and feelings of each other's experiences.

For this research I had a total amount of 14 respondents. I interviewed 6 people, ages 17 to 23 and held two focus groups, one group consisting of 3 people and the other consisting of 5. A vast majority of the respondents were migrants, with two respondents being second generation migrants. For the one on one interview a snowball sampling was used, my respondents and research partners shared the contact information of people they knew would be interested. They also shared a collective message on WhatsApp, explaining the research and the procedure, which led to 1 of the respondents reaching out to me. The gender ratio was not equally divided as most of my respondents were women, only 5 of my respondents were men, and most of whom participated in the focus groups. The respondents were from the surrounding Islands and South American countries, the origin countries that were mostly represented were Colombia, Venezuela, Haiti and the Dominican Republic. The majority of the respondents were students, either in high school, university or vocational schools.

All of the one on one interviews and one of the focus groups were audio-recorded. Data collection was further aided by notes taken after. For the other focus group the only method of data collection was note taking. Before the interviews started the research was explained, either verbally or through the written consent form. The consent form was translated into Papiamentu and Dutch for the respondents who felt

more comfortable with those languages. The consent form was sent to the respondents before the interviews. They were informed that they could withdraw from the research until the 3rd of April 2023, none of them reached out with such a request. The audio recordings were transcribed, after the transcriptions were complete the voice recordings were deleted. Within the transcription process the respondents were made anonymous.

Some of the limitations of my research is my sample size, as well as the lack of diverse background within my sample size. Furthermore, as explained above, most of the respondents who identified as men joined the focus groups and not the one on one interview. Thus, I did not have as much of a chance to discuss the personal experiences of young men migrating to Aruba in depth, apart from one respondent. Another limitation is my lack of the necessary languages, multiple of my respondents felt more comfortable talking in Papiamentu or Spanish, as I know neither of the languages we conversed in English. This opens up space for misinterpretations and miscommunications.

5.2 Analysis

To analyze the data, thematic analysis was used. For the analysis I decided to use an inductive approach as it made it possible to stick to an interpretivist framework. Inductive approach entails deriving themes that are "data-driven" to ensure a "bottom-up" understanding (Kiger 2020, Braun 2006). I am using the 6-step plan method that has been outlined by Braun and Clark as it is a widely accepted methodology for thematic analysis (Kiger, 2020). The transcriptions obtained from the interviews are being studied on and read multiple times by the author to familiarize themselves with the data. From the transcriptions I derived initial codes, as it has been laid out by Braun and Clark (2006). I am abstaining from framing the codes in a hierarchical order as my interpretivist approach requires.

This entails that there was not a separation of importance

or relevance attached to the key themes that have been identified within the interviews. Whether or not a theme presented itself for multiple of the respondents or only one, did not alter the importance attributed to the theme, however common themes within respondents answers and patterns were noted through the mind map that is being created to formulate preliminary “themes”. While formulating the themes a semantic approach was decided upon and identified the themes based on “...the explicit or surface meaning” of the respondents explanations. This necessitates refraining from assumptions, generalizations or ideologies as well as not interpreting underlying meanings (Braun, 2006). The semantic approach was particularly useful for the interpretivist framework I am following for this research since it places value on not imposing value judgments to what my respondents have shared with me based on their lived experiences. The themes will be reviewed, assessing if they are adequately supported by the codes and then proceeding on finding sufficient representation within the transcriptions. From this two-step process, a final definition for the themes will be reached on the sense of belonging experienced by young migrants who moved to Aruba.

5.3 Limitations

Among the limitations of my research is my sample size, as well as the lack of diverse backgrounds within my sample. All of my respondents were from this part of the world, which means that I didn’t get a chance to converse with young people coming from backgrounds other than Latin America and the Caribbean. Furthermore, as explained above, most of the respondents who identified as men joined the focus groups and not the one-on-one interview. Thus, I did not have as much of a chance to discuss the personal experiences of young men’s migration to Aruba in depth, apart from one respondent. Another limitation is my lack of the necessary languages, multiple of my respondents felt more comfortable talking in Papiamentu or Spanish, as I know neither of the languages we conversed

in English. This opens up space for misinterpretations and miscommunications. Especially since belonging is a complex and intricate feeling, the language gap presents itself as a potentially serious limitation.

5.4 Positionality statement

I am a 22 year old Turkish woman(?)³ coming from an upper-class socioeconomic background and I am about to obtain my bachelor’s degree from a university in the Netherlands. My positionality not only influenced how I interacted with my respondent but also with my data, in fact, I can argue that my background is one of the main reasons I wanted to research migration. I realized that my Turkish identity and sense of belonging to my country increased the more time I spent in the Netherlands. I further realized how I was growing and changing in different directions as opposed to my friends who are still living in Turkey. These realizations made me spiral into hours of contemplation, which I can essentially summarize as “trying to find my place within this world”. Furthermore, I got a chance of witnessing, first hand, how Turkey’s approach to migration was completely different from The Netherlands. I could observe how the politics, demographics and culture resulted in different reactions from the locals, and different experiences when it came to the migrants. I found myself relating to other people who moved from their origin country, and started viewing “migration” as a phenomenon that both connects people, and a new set of experiences that are difficult to explain and maybe even harder to understand. I observed how the “othering” Turkish people experience in the Netherlands depend more on socioeconomic situation, and less on Turkishness⁴. Lastly, I have spent the last decade of my life arguing at dinner tables, passing conversations, and classrooms and (occasionally) streets for a world without borders.

As you can see, I began this research not with a clean slate but with enough contemplation and experience to fill multiple journals. With enough information to know

that I can not possibly know anything important with regards to the experiences of young migrants in Aruba, and enough curiosity to still ask. I do not have any answers, and I don't suppose I will reach a conclusion any time soon. Nonetheless, I feel grateful to Aruba and to all of my respondents for showing me a new context, a different world and a completely different way of experiencing migration.

6. Preliminary Results and Discussion

The results and the discussion is both the most important and the most difficult part to write for me. For starters, I want to state that the analysis of the data is still ongoing so the results and thus the discussion will most likely be updated, these are just the preliminary findings. However, there is another reason for the difficulty I experienced writing this part, every theme seems to be connected to the other themes, it is very difficult to explain how 'mobility' plays a role within my respondents' lives without also mentioning 'documentation', while their 'family's and relations to others stand in the middle of everything, the 'boundaries set by others on their sense of belonging' comes out of a tangled piece of yarn of 'documents' and 'mobility'.

6.1 Family

A majority of the respondents talked about their families when the questions of "belonging" were asked. More specifically, an overwhelming majority of my respondents mentioned their families when asked about what 'home' was for them. One of my respondents (5) answered the question regarding their home saying "I think home is where I'm happy, and yeah, my home is like my family and also my cats and my dogs". Home for them was attached to happiness and family. They did not mention a specific location or a place, stating that anywhere their family was could be home. With this regard, for my respondent (5) the physical and the material aspects of home do not seem to be as important as literature would suggest. Liu states that 'home' is the materialized location of the emotional

attachments people form, and thus is both physical and sentimental (2012). Although my respondent didn't specifically give a 'place' for their home, they stated that the house didn't feel like a home and when asked said that they "could call Aruba home.

One of my respondents (4) stated that they had "different homes" and explained that their house feels like a home when their family is in it. They further stated that they feel at home in their origin country, even though it feels difficult to feel at home there. They tied this to the fact that they spend most of the year here in Aruba, and explained that as time passes by in their home in their origin country it becomes easier. The understanding of family as home, as well as what my respondent explained with regard to their house outside of Aruba has been studied and experienced by Liu. In her research she draws from her own experiences as someone who returned back to China, even for a seemingly short while, after migrating to New Zealand. She writes of her difficulties feeling at home in her first months and adds "Eventually, when this journey came to an end, I found that I was once again just one of the people who belonged there" (Liu, p21, 2012). On a similar line, my respondent (4) stated that as time passes by they feel more comfortable in their origin country. Belonging is a continuously changing and readjusting concept for both Liu and the respondent (4).

6.2 Documentation

When it comes to documentation, the respondents who were denied citizenship' experiences differ then their so-called "legal" counterparts. Lack of documentation leads the respondents to be stuck on the island, taking away their ability to participate in the workforce, and joining in some of the activities with their peers like obtaining driving licenses or going on exchange. Some of the participants are left with no choice but to continue their school life although they are legally adults, and would prefer to work instead. In ways, by denying them documentation the government is

placing a barrier in front of them gaining capital (Schinkel, 2018).

From these directions a lack of documents ties them to the island of Aruba both geographically and to some of its institutions. Without documentation, the respondents can not participate in life as adults which leaves them frustrated. One of my respondents, (2) stated this frustration as

“Sometimes, sometimes I feel happy, sometimes I feel really sad because I am.

Yeah, I would like to be more independent./ And right now I cannot do that because I don't have my legal papers”

While answering my question regarding their happiness here. This lack of independence sometimes translates into a loss of sense of belonging, at a different point within the same interview my respondent (2) stated that

“Like I love the island, and sometimes I just want to leave just because of that. Because yeah, I don't feel like I belong here because I don't know that that makes you feel that I'm not being accepted.”

Similarly, another one of the respondents (6) stated that they did not feel like they belong to Aruba, because of being undocumented. The literature on belonging suggests that although it is a personal experience the boundaries other's set have impact on the sense of belonging of individuals (Jones et al., 2008). Consequently, one of the ways belonging is politicized is through national borders, and who is allowed to reside within them and who is not. Although my respondents have an emotional connection to the island, because of the boundaries set in front of them they can not feel as though they belong sometimes.

Furthermore, most of the respondents who didn't have their documentation, have plans and desires of migrating to a

third country. Without the documents they are left unable to do so. As explained above, they also continue their ties with the country through being enrolled in its schools. Moreover, because they can not leave Aruba, their spatial connections with their origin country is blocked. Hence, documentation affects their mobility directly. The lack of documentation results with a loss of independence not only within the borders of the island, but also within the bigger world. Mobility is one of the themes that kept on reappearing in different forms through the interviews and focus groups.

6.3 Mobility

As stated above, most of the respondents have plans or at least desires of migrating to a third country. Being in Aruba has great importance within these plans, but more importantly the accessibility of Aruba makes it possible. Most of my respondents stated that with their passports most of the Global North⁵ is inaccessible, while Aruba was. With an Aruban passport they (hopefully) will have the opportunity of migrating to another country that will give them better opportunities. Furthermore, witnessing their families' willingness to move to their origin countries for a better life provides one of my respondents (5) with a sense of self that is willing to do the same for their life. From here we can observe that although specific themes can be drawn from the data, the themes are interconnected and relate to one another. Just as documentation is related to mobility, mobility is related to familial relations.

Another aspect of Aruba that influences the desire of moving elsewhere for my respondents was how many people migrate from Aruba to begin with. As they are growing up, my respondents were being prepared to go to university in The Netherlands alongside with their classmates⁶, hence mobility is present in their lives in various forms and from various directions.

6.4 Better Life

This is tied to how an overwhelming majority of my

respondents view Aruba as an opportunity for a better life, more importantly a life that is in progression. Multiple of my respondents expressed that had they stayed within their origin countries they would have a stagnant life. Here not only do they have access to a better job market, education and new languages but as explained in the previous paragraph they have access to the rest of the world. Some of my respondents also expressed that being in a multicultural society made them more “open minded” people, and led them to understand other’s experiences more. Another part of the opportunities that my respondents mentioned in Aruba was schools, and the psychosocial aid they received at schools. All of these positive experiences made them feel more connected to Aruba and heightened their sense of belonging to the island, in the meantime, it also gave those who want to move to a new place better chances, connecting them to a wider world. This is one of the many ways multiple, and even seemingly exclusive belongings can be present in people simultaneously (Jones et al. 2008).

6.5 Boundaries to Their Sense of Belonging

Some of the factors that kept ties between the respondents and their origin country was language and food. For the Afro-Caribbean respondents the Black community they had was amongst the strong losses they felt after arriving in Aruba. From their experiences, their race affected others’ perception of them. They defined Aruba as a country who is not aware of racisms⁷, which obviously had a negative impact on their experiences. They stated that they felt a strong sense of belonging to their Black community back in their origin country.

When it comes to the Latin American respondents, they have expressed unpleasant comments about Latin American (and mainly Venezuelan) migrants from their peers, and teachers. Interestingly, some of the Colombian respondents stated that they were assumed to be Venezuelan, which led to discriminatory behavior. One of my respondents (2) while talking about their friends explained

“Sometimes I think they forget that I’m not Aruban, so they start talking about friends of like people from my country, like Venezuelan people and like. I don’t know, like the Aruban perspective. Like they are, they are not from here. They’re stealing their jobs and things like that. So that like sometimes I’m like, Oh my God, that’s me you’re talking about me”

They continued explaining that they became insensible to those comments when it comes from people they don’t know, but when the people are close to them they feel bad.

7. Conclusion

Migration, in and of itself is a unique and life changing experience for a variety of different reasons and forms its own ways of relating and belonging. It can not be generalized. I started this research with a desire to see migration as a route of forming its own narrative. What constitutes its difference is not the nationality or ethnicity of the migrants but the movement and change they experience. Everyone has a different way of dealing with the change that arrives, and unquestionably the intersecting identities have a huge effect on how migration is experienced, intersections between documentation, socioeconomic class, race, gender, ethnicity and language all lead to a different set of experiences. Within the globalized world, living through moving has the potential of introducing new forms of belonging that are worthy to be researched and understood for it offers something new. (It is also not to say that having migrated to Aruba was the most important aspect that influences their lives, for I do not believe it was for at least some of my respondents, it just creates an opportunity to find new ways of relating to a space).

Experiences of sense of belonging for migrants can be useful for the entire population, not as a way of aiding the governments on how to better integrate⁸ the migrant population, but on how everyday people can, deal with

and ultimately embrace the continuous change that has been a part of our daily lives. As Jardim and Silva start their article with the difficulty of European countries on accepting migrants, the experiences and narratives used by migrants on making sense of their new surroundings could be beneficial for the locals who are refusing to make sense of the newcomers (2021). Certain ideals of learning new languages, trying for better opportunities, learning to accept the other, and experiences that are more determined by relations.

Not every change is positive, nor should be embraced but within our current world the fear of change results with people clinging to increasingly conservative ideals. If we can actually look at migrants' experiences not to theorize how they are different but to see if it could be adopted, maybe a more constructive answer could be found on how the host communities can better host the newcomers.

Endnotes

1. I do not have the word count nor the knowledge to discuss the ethical implications of an oil refinery for this paper
2. me
3. Need more time to figure out gender
4. whatever that means
5. For lack of a better word, for this context it refers to the European Union and the United States
6. It is important to note that this is an experience only the socioeconomically privileged (or academically inclined) respondents shared
7. oh boy do I know it's not my place, nonetheless it really is
8. whatever that means

Sources

- Alofs, L. J., & Merkies, L. (2001). Ken ta Arubiano?: sociale integratie en natievorming op Aruba, 1924-2001.
- Black, I. (2006). The presentation of interpretivist research. *Qualitative Market Research: An International Journal*, 9(4), 319–324. <https://doi.org/10.1108/13522750610689069>
- Braun, Virginia and Clarke, Victoria (2006) Using thematic analysis in psychology. *Qualitative Research in Psychology*, 3 (2). pp. 77-101. ISSN 1478-0887
- Chowdhury, M. E. H. (2014). Interpretivism in Aiding Our Understanding of the Contemporary Social World. *Open Journal of Philosophy*, 04(03), 432–438. <https://doi.org/10.4236/ojpp.2014.43047>
- Dahinden, J. (2016). A plea for the ‘de-migranticization’ of research on migration and integration. *Ethnic and Racial Studies*, 39(13), 2207–2225. <https://doi.org/10.1080/01419870.2015.1124129>
- Definition of assimilation. (2023). In *Merriam-Webster Dictionary*. <https://www.merriam-webster.com/dictionary/assimilation#:~:text=Assimilation%20refers%20to%20the%20process,life%20of%20an%20embracing%20culture>
- Delanty, G., Wodak, R., & Jones, P. (2008). *Identity, Belonging and Migration*. Oxford University Press.
- Easthope, H. (2009). Fixed identities in a mobile world? The relationship between mobility, place, and identity. *Identities-global Studies in Culture and Power*, 16(1), 61–82. <https://doi.org/10.1080/10702890802605810>
- Jardim, C. M., & Da Silva, S. M. (2021). Belonging among young people with migrant background in Portugal: local, national, and transnational identifications. *Social Identities*, 27(2), 229–244. <https://doi.org/10.1080/13504630.2020.1816459>
- Jones, P. J., & Krzyzanowski, M. K. (2008). Identity, Belonging and Migration: Beyond Constructing “Others.” *In Identity, Belonging and Migration* (pp. 38–52). Liverpool University Press.
- Kiger, M. E., & Varpio, L. (2020). Thematic analysis of qualitative data: AMEE Guide No. 131. *Medical Teacher*, 42(8), 846–854. <https://doi.org/10.1080/0142159x.2020.1755030>
- Liu, L. S. (2014). A search for a place to call home: Negotiation of home, identity and senses of belonging among new migrants from the People’s Republic of China (PRC) to New Zealand. *Emotion, Space and Society*, 10, 18–26. <https://doi.org/10.1016/j.emospa.2013.01.002>
- Mayr, H. M. (2020). The Condition of ‘Illegality’: Deconstructing the ‘Illegalization’ of Undocumented Venezuelans on Aruba. *UAUCU Student Research Exchange Collected Papers 2020*.
- CBS Aruba (2022, June 16). Quarterly Demographic Bulletin 2022. <https://cbs.aw/wp/index.php/2022/06/16/quarterly-demographic-bulletin-2022/>
- Schinkel, W. (2018). Against ‘immigrant integration’: for an end to neocolonial knowledge production. *Comparative Migration Studies*, 6(1). <https://doi.org/10.1186/s40878-018-0095-1>
- Waldinger, R. (2017). A cross-border perspective on migration: beyond the assimilation/transnationalism debate. *Journal of Ethnic and Migration Studies*, 43(1), 3–17. <https://doi.org/10.1080/1369183x.2016.1238863>
- Youkhana, E. (2015). A Conceptual Shift in Studies of Belonging and the Politics of Belonging. *Social Inclusion*, 3(4), 10–24. <https://doi.org/10.17645/si.v3i4.150>
- Yuval-Davis, N. (2006). Belonging and the politics of belonging. *Patterns of Prejudice*, 40(3), 197–214. <https://doi.org/10.1080/00313220600769331>



Jasmine Coelho, University College Utrecht

My time in Aruba has been a whirlwind of wonder.

My time in Aruba has been a whirlwind of wonder; from wondering how to narrow down my research to wondering how to get to school without a car, it has been a real adventure to say the least. From boat excursions in the first 24 hours to hitch-hiking across the island, this field research programme in Aruba has been without a doubt one of the most formidable experiences in my life. I'm really grateful for the time I've had here because it has taught me a lot about the world and a lot about myself.

Every day I am more and more astounded at the warmth of the people here in Aruba who really have enriched my time here by teaching me so much about culture and community on the island. I'm thankful for all the mentors who went above and beyond to help us, especially Eric, Jocelyn and Carlos for helping make Aruba home for a little while. I'm so glad to have the experience to learn so much in such a short amount of time while forming bonds that I know

will last a lifetime. A big thank you to Clifford Rosa at Stichting Rancho for letting us be a part of his community through volunteering and to sharing the beautiful culture of Rancho with us. I am so lucky to have the chance to have made such great friends here who have shouldered both the ups and downs with a smile and drink in hand. Shoutout to Alexandra, Andrew, Abi and Ray who are the sweetest Arubans ever and the best reasons to come back to this beautiful island.

I feel it has been a journey with a lot of growing pains but in the end I will say that I am so extremely proud of what we've accomplished here. Although it took a lot of workshopping to get to a feasible research idea, I am so proud of the way everything eventually came together in the end. I am thankful to everyone who participated and to all of those who helped in even the smallest of ways. Special thanks to my AFY research assistant, Tajikah Richardson, who also

became a huge inspiration for my research project. Overall, I am just blessed to have the opportunity to experience such a transformative journey here in Aruba and I really hope I can come back soon.



Framing culture: exploring the perceptions of the Aruban cultural identity and the role of murals in representing it

Jasmine Coelho

Identity

*Truth is, I'm not fully secure in my identity,
for my whole life I've been told I'm not that pretty.
It's not because I'm conventionally unattractive,
it's because of my complexion,
that's it.*

*I'm not fully secure in my identity
because society has an image of what black is supposed to be,
a mold I should fit into.
Narrow minds who see me as someone who is trying to be white
because of what I'm into.*

*I will be honest,
it has crossed my mind that it would be easier if I were white,
that I wouldn't have to fight
for the right to be free.
Wouldn't have to struggle to love all my features
and culture unconditionally.*

*Although I'm not fully secure in my identity,
I'm happy with how far I've come,
I'm happy with the black person I'm becoming.*

*I'm no longer that little black girl filled with hatred,
no longer that girl who hated her 4c hair and needed it
straightened,
no longer that girl who hated her lips,
the same lips that are speaking so eloquently.*

*No longer that girl who couldn't look in the mirror and see her own
beauty.*

*So although I'm not secure in my identity
I'm finally becoming a person I can be proud of,
I'm becoming the very black excellence that I've always dreamed of.*

*So no, I'm not fully secure in my identity
but one thing my people have taught me
is that I am strong.*

*My people did not march, protest, survive and persevere
for me to get bossed around.
I no longer will allow anybody to police me on my blackness,
on whether I'm pretty for a black girl
or whether I'm well spoken for a black person,
because I'm ready to be fully secure in my identity.*

Tajikah Richardson

Introduction

Asking an individual to describe what makes them who they are would result in them outlining their identity. As a complex concept, identity is the shifting frame we use to interpret the world and the way we frame ourselves to be interpreted by the world. Influenced by factors such as ethnicity, religion, history and culture, identity is multifaceted and constantly changing. Identity is dynamic. The three truths that exist in identity are where we come from (past), who we are now (present) and who we want to become (future). Identity is malleable. From these truths, we understand that there are core influences of cultural heritage that form a foundation that constitutes who we are. This is the starting point from which many start to negotiate their identity. As social creatures, human beings need each other and so we formed a community. Within the community, we also have a quest to find our place and how we relate to others within and beyond our community. The cultural identity that is shared by the community fulfils our search for belonging.

The manner in which cultural identity is formed is based on the shared conceptual maps, culture, of a community and how it is represented. Stuart Hall, a Caribbean-born cultural theorist, explored the complexities in cultural identity construction and the role of representation in this process. Many people use their cultural heritage as the foundation for their cultural identity and the representations of this heritage can affirm and negotiate their cultural identity. Hall (1990) institutes a framework for understanding cultural identity based on the principles of similarity and difference. Hall (1997) posits that representation, a means to communicate cultural identity, is imperative in shaping our perceptions of our cultural identity. He proposes that the collective community searches for a cultural identity rooted in the shared history and ancestry based on migration that negates all superficial differences that can occur (Hall, 1990). Additionally, the collective community positions themselves in opposition

to other cultures, migrant or otherwise, in a way to better understand their own cultural identity (Hall, 1990). Hall ties this framework together with the concept of representation which is the “signifying practices and symbolic systems that discursive constitute and (re) produce meanings and subject positions” (Moss, 2010; Hall, 1997; Woodward, 1997). While representations can come in many forms, the visual language of art has the ability to capture the complexities of cultural identity using cultural codes emblematic to a community. Murals, especially, offer a unique insight into the “concerns of a community” through an expressive yet accessible technique (Barnett, 1984).

One such concern is the negotiation of cultural identity which is captured in the powerfully poignant words of Tajikah Richardson that is used to begin this paper. Tajikah, a third-generation Aruban, shares her struggles to find her place within her community and in relation to others in her community. As she addresses her concerns with beauty standards, conformity and political consciousness, she positions herself in opposition to other members of the Aruban community in order to establish points of similarity and of difference. She addresses questions of race in a pluralistic society built on centuries of cross-cultural exchange that have shifted what it means to be Aruban. She finds her place among others who share her struggles, speak her language and celebrate her traditions. Tajikah also finds her place in what she is not. She expresses the characteristics that sets her apart from others in her community and uses this difference as a celebration of plurality within herself, and within her community. Her poem highlights the dynamism of cultural identity as transmutable names we give ourselves that are in a constant state of development. Through her vulnerability, Tajikah captures the uncertainty that comes with the dynamism of cultural identity that triggers continuous negotiation of one’s place in the society. Tajikah’s sentiments in her quest to conquer her cultural identity have been immortalised on the walls of the city she calls her home, San Nicolaas.



Tajikah by SEPC for Aruba Art Fair (Source: Researcher)

She becomes an emblem, a visual cultural code, that refers to the struggles of Aruban youth to negotiate their cultural identity in a plural society which is in constant flux.

The cultural identity of the Aruban people is represented in the mural movement started in 2015; it captures the creolised culture of Aruba that can only be understood as a stew pot of cultures. Unlike a melting pot, the different elements of culture that constitute the Aruban cultural identity are not indistinguishably mixed into each other. To the trained individual, the different ingredients are recognizable and dominant flavours can be traced to each ingredient (German, 2003). With each additional cultural ingredient, the flavour of the Aruban cultural identity changed, and it tastes different to each person. In an attempt to reconnect the Aruban people to their cultural heritage and identity, the Aruban government commissioned the establishment of cultural disseminating institutions such as museums; however, these remain accessible to a certain demographic, while having no effect on the wider majority. The mural movement in Aruba led by ARTISA paved an accessible and engaging way to (re) connect the community to their history and cultivate a connection to

their cultural identity (Bolívar, 2023). The murals offer a site for cultural expression based on significant cultural codes that constitute the Aruban identity. This formed a crucial (re) education programme as the education system in Aruba does not educate local students on their island's history. In this capacity, the murals are a tool of refusal to conform to the inadequate education curriculum and offer space to cultivate a new society based on a cultural identity linked to narratives of heritage.

Grounded in the cultural identity theory and the works of Stuart Hall on representation and cultural identity, this research aims to explore the perceptions the Aruban community have on their cultural identity. These perceptions were captured using photovoice method, a participatory action research method, which localises the data within the lived experiences of the community. Additionally, the research questions the role of murals as a mode of expressing cultural identity as a tool for reconnecting Arubans to their cultural heritage and as a tool for (re) education. The ideologies that contribute to the Aruban cultural identity are contextualised into themes that highlight the enduring and changing aspects of Aruban identity. This contributes to efforts in heritage conservation on the island and celebrating intersectionality in the community.

Creolisation of Aruba

Aruba, like most Caribbean territories, has been influenced by migration that has shifted the demographics, social structures and economic development and has led to creolization. Migration and creolization are inextricably linked as historical processes that have led to the cultural development of many Caribbean cultures, like Aruba. Creolization is defined as the “cross-fertilization between different cultures as they interact” where members of a culture adopt select elements from “incoming or inherited cultures” by ascribing them a new cultural meaning (Cohen,

2007). With each cultural encounter triggered by migration, the Aruban cultural identity shifted into a new cultural variation that superseded the previous cultural form.

Migration is the inception of culture on the island of Aruba as even the first inhabitants of the island, the Caiquetio Arawak people migrated from Venezuela in 850 BCE. The Amerindian culture thrived until the arrival of the Spaniards in 1499 which marked the first European encounter of colonisation. The island was taken over by Britain and then the Netherlands who took control in 1636 through the Dutch West India Company (WIC) before turning Aruba into an official colony in 1754 (Alofs, 2008). The cultural exchange between the local Amerindian population and the European settlers diversified in 1863 when the abolition of slave trade introduced a newly found peasant culture in absence of the plantation economy (Alofs, 2008). This incited a cultural shift with the introduction of a new cultural demographic as the “colonists, Indians, and blacks intermixed forming the traditional Mestizo-Creole population” (Alofs, 2008).

Migration incited further cultural development in Aruba around the 1920s after the economic structure shifted from plantation-focused (*cunucu* culture) to wage based labour force. With the introduction of the oil industry on the island, a process of rapid industrialization took place, especially in San Nicolaas where the oil refinery and main port were situated. With a lack of skilled industrial labourers within the native population, the demand for labour attracted a multitude of “industrial labourers, merchants, and civil servants from the Caribbean, Europe, the Americas, and China” (Alofs, 2008). This saw the island’s population increase from 9,000 to 55,000 in about 30 years (Razak, 1995). The traditional population was surpassed by the Afro-Caribbean migrants in economic and socio-cultural status and the traditional economically elite position was adopted by the Lebanese, Jewish and Chinese migrants (Alofs, 2008).

With the decline of the oil industry, Aruba was forced to shift to tourism, at that time, as the secondary economic sector. Tourism in Aruba represented this revolutionary change that established a cultural connection with the wider world and integrated the Aruban economy with that of the International market. With tourism as a budding sector with promising potential, the second wave of migrants from the Caribbean, the Americas, the Netherlands, and the Philippines came to the island (Alofs, 2008). In addition to the labour migrants, the tourists who mostly came from North America brought with them Americanism and consumer culture. With an economic structure reliant on extraversion, the Aruban people needed to be culturally flexible and open to adapt easily to the influx of external cultures.

Theoretical Framework

This research is grounded in cultural identity theory by Collier and Thomas (1988), which explores “how individuals use communicative processes to construct and negotiate their cultural group identities and relationships” (in Cultural Communication, 2014). This theory posits properties of cultural identity which act as starting points for deconstructing how identity is communicated within a cultural group. These properties include avowal and ascription, modes of expression, components of identity (individual, relational and communal), aspects of identity (affective, cognitive and behavioural as well as enduring and changing), content and relationship levels, and salience or prominence (in Cultural Communication, 2014). While these properties are of equal importance and all contribute to a richer understanding of cultural identity, this research draws on the properties of expression, avowal and ascription, and the enduring and changing aspects of identity. These properties are used to theorise the concepts of murals as a mode of expression, the perceptions Arubans have of their cultural identity as a process of avowal, and the intersectionality within the Aruban cultural identity as enduring and changing elements of their identity.

Murals are theorised to be a mode of expression that can be used to frame cultural identity, as they tap into a system of representations based on shared cultural codes. The modes of expressing cultural identity refer to the manner in which core symbols, the “expressions of a group’s cultural beliefs and theories about the world around them”, are communicated (in Cultural Communication, 2014). Murals in this context, take the shared cultural codes and translate them into a visual expression of cultural identity. Stuart contextualises the connection between cultural identity and representation as mutually influential. Hall posits that representation is the framework in which cultural identity is constituted. Representation “connects meaning and language to culture” by working with symbols that have been cultural meaning attributed to it and translating it with language (Hall, 1997). Hall uses a constructivist approach to advance that the meaning that is found in representation is constructed both in and through language (Hall, 1997). Murals are based in a visual language that tap into a culturally established *system of representations* that hold specific meaning to the cultural group and their identity (Hall, 1997). This system is based on a set of signs that come to symbolise a wider set of meaning that individuals can use as points of reference (Hall, 1997). This system taps into the shared conceptual map of a cultural group and provides a pool of knowledge that language can translate into an interpretable, *common language*, like art (Hall, 1997).

The ability of murals to effectively represent cultural identity are dependent on the perceptions that Arubans have constructed of themselves during the process of avowal. The process of avowal involves the way in which members of a community articulate their view on the group identity based on self-identification (in Cultural Communication, 2014). The perceptions the Aruban community have on their cultural identity will be based on what is represented in the murals and what they believe is representative of their cultural identity. This is based on the individual concept of cultural identity where the

individual member interprets the group identity based on subjective experiences. The individual concept of cultural identity in turn creates, affirms and negotiates the shared cultural identity. By exploring this property of cultural identity, it highlights how the construction of an Aruban cultural identity is based on cultural codes that represent how Arubans see themselves. This will contextualise the murals within varying discourses surrounding Aruban cultural identity. Murals as tools of “ideological storytelling” capture the nuances of cultural identity within a specific narrative context (Poon, 2016). The discourse in which a mural is situated will reflect the discourse that each participant situates themselves and their culture in. This can also be used to offer insight into the overlapping nature of cultural identity, influenced by multiple discourses that contribute to a more holistic understanding of the Aruban cultural identity. By recognizing the opportunity for this multiplicity, the potential to capture intersectionality in the cultural identity is greatly increased.

This intersectionality is important to explore within the research as it highlights the enduring and changing aspects of the Aruban cultural identity and how the murals capture these shifts. Cultural identity as a dynamic concept is at liberty to different factors of social, political, economic and contextual influence. This is ratified by Stuart Hall’s understanding of cultural identity as a place in which we position and are positioned in relation to others. Hall (1990) advances that cultural identities are the “points of identification” that are contextualised within “discourses of history and culture” but are positioned rather than essentialised. In this philosophy of interpreting cultural identity, the boundaries of similarity and difference between members of the same and different cultural groups are constantly being revisited. The acknowledgement of this highlights points of *enunciation*, the lived experiences, from which individuals express their cultural identity and the contexts in which it changes (Hall, 1990). Furthermore, this theory grounds the cultural identity within a historical

context of production while highlighting the possibility of negotiation as cultural identity is in a constant state of *play* with history, culture and power (Hall, 1990). The enduring aspects of cultural identity will inform a deeper understanding of what elements of Aruban cultural identity serve as “stable, unchanging, continuous frames for reference and meaning” (Hall, 1990). The changing aspects of cultural identity will illuminate the negotiation of cultural identity based on *positioning* (Hall, 1990). This is imperative when exploring a pluralistic culture with a large variety in demographics that position each individual differently in context and in representation.

Literature Review

Cultural identity through murals

Cultural identity and murals have their meaning constructed within and through each other. Murals use imagery inspired from the expressions of cultural identity to represent it while cultural identity uses murals as a site for constructing, affirming and negotiating cultural identity. Mural movements across the world have been used to communicate cultural identity through means of heritage celebration, education and advocacy for change.

Murals serve as an ideal mode to express cultural identity because it is considered an art of the people. Beyond the ivory tower of gallery art but rooted in a rich artistic history in its own right, murals are a bridge between what is considered “high art” and “low art” (Moss, 2010). While murals rely on a repertoire of artistic skill, they remain accessible to the general public in both physicality and subject matter which make it “communal art” (Moss, 2010). Barnett (1984) advances that murals are a “movement of authentic people’s art” as it is close to the people and reflects the “concerns of the community”. Community murals are created in tandem to everyday human experience that infuse it with the essence of the local culture. They are a

“mirror of life” as they are infused with “local cultural essence and character” (Sadatseyedmahalleh et al., 2018). Murals offer referents for cultural identity through tangible and intangible elements infused with shared cultural codes (Escorteganha et al., 2013). Murals reference a “system of representations”, a set of wider meanings symbolised by culturally agreed upon signs, to communicate cultural identity to and beyond a community (Hall, 1997). These signs hold great value to a community as they are symbols of shared history and experiences that contribute to their cultural identity. In an interview with Mónica Lettieri (2001), the Chicano artist Leo Tanguma spoke on the use of murals as a means to reconnect the Chicanos with their Mexican heritage while acknowledging their contemporary cultural identity in America. Tanguma referenced the use of cultural symbols, which have been “taken away and neglected”, to trigger communal contemplation on their cultural identity. He argues that Chicano artists illustrate their “cultural and historic symbols in great public view” with murals in order to “stimulate the community to discover their own past” (Tanguma, 2001). These symbols are publicly displayed through murals as a way to reconnect people to their cultural heritage.

Murals also act as a site for empowerment by celebrating cultural heritage through ideological storytelling. Interpreting the images that constitute murals can prove to be extremely useful in “revealing implicit values and ideologies” that inform cultural identity (Moss, 2010). These ideologies act as factors such as ethnicity, history or religion that influence the construction, affirmation and negotiation of cultural identity. As a mode of expression, murals actively communicate cultural identity by using “ideological storytelling” to narrate the lived experiences of the community (Poon, 2016). The ideology that is used in murals can be grounded in community empowerment through the celebration of heritage. A study on the mural movement in El Salvador highlighted the role of murals in mediating a connection to the heritage of the people

within the tumultuous time of the revolution. Murals referenced cultural symbols in an attempt to “construct a shared cultural identity as it actively defines, interprets and debates the nation’s historical meaning” (Heidenry, 2014). Contextualised within the struggle to negotiate national identity at a time of conflict, murals became a point of reference which the people could return to.

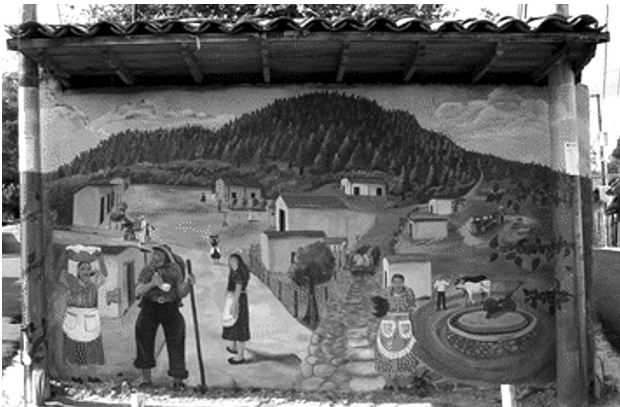

Walls of Hope. Memorias de los Niños de Ayer (2008) in Morazán (Source: Rachel Heidenry 2012)

As “touchstones for identification” the murals in El Salvador relied on the cultural imagery relating to Salvadoran history to “reclaim local identities, subvert contemporary struggles and exert political power” (Moss, 2010; Heidenry, 2014). Murals provided a forum for celebration of heritage to empower the community with imagery of peace in a time of struggle.

Murals can also make a commentary on the struggles of cultural cohesion within the community in order to advocate for change. Murals can be used to unpack the process of negotiating cultural identity positioning within a multicultural arena. As public art, murals become innately connected to the social discourse of a community and

can be used as a tool to advocate for social coherence. A study conducted in Malaysia on murals as a unique source of tangible cultural heritage, proposes that they can be used to celebrate pluralism and cultural cohesion within a multicultural society (Poon, 2016). The author, Stephen Poon, argues that in Malaysia, “multi-ethnic imagery” based on the “multicultural experiences” that occur on the group of islands serves to celebrate and advance “cultural harmonisation” (Poon, 2016). This is because murals can be referents for identification that can validate cultural identity and individual positioning within it (Hall, 1997). This not only advocates for the mediation of cultural tension but highlights intersectionality that is present within the interpretations of cultural identity.

Mural movement in Aruba

Mural movements are characterised by their relation to the struggle of negotiating cultural identity and it is no different in Aruba. With little published literature on the subject of murals in Aruba, news articles and interviews with key informants were used to explore the development of the mural movement in Aruba. Unlike many mural movements, what Aruba faces is not a political struggle to negotiate identity but rather a cultural one. The Aruban mural movement began in 2015 when the Aruban Government implemented a cultural action plan to re-brand San Nicolaas, the site of the oil-refinery, from a post-industrial ghost town into a cultural capital (Bolívar, 2023; Geronimo, 2023). The government worked collaboratively with Art Is Aruba (ARTISA) to plan ways to remodel the cultural landscape of the city and the Aruba Art Fair was born. Aruba Art Fair had its debut in November 2015 hosting muralists from across the world in San Nicolaas for a multi-day festival of art, music, food and community (Bolívar, 2023).

Each year the muralists are invited to create a mural based on a theme relevant to the community such as conserving

nature, community vices and local heroes. Inspired by the mural movement in Colombia, the Aruban mural movement aims to address the Aruban “concerns of community life” (Barnett, 1984). The artists are invited to conduct in-depth research into the cultural motifs that can be used to construct a telling narrative that aligns with the theme. In this way, the murals are used to raise awareness on local challenges such as the problems of gambling addiction. The Czech muralist, Chemis, used his work *House of cards* to problematize gambling as a vice in the community.



House of Cards (2015) by Chemis for Aruba Art Fair (Source: Chemisland)

The location of the mural itself holds great significance as murals are contextualised within their environment. This mural by Chemis is painted on what used to be a Casino for the people of San Nicolaas. By placing the mural in that location, the mural becomes part of the “historiography and performed layered extension” of communal cultural identity (Heidenry, 2014). Murals affect the public landscape embedding their iconography onto existing cultural sites to make a commentary that aims to trigger meaningful contemplation.

The mural movement, as a rebranding project, also has an explicit goal of (re) education for both the incoming tourists on the local culture and the local people to connect them with the history that constitutes their cultural identity (Bolivar, 2023). The current education system in Aruba, as part of the Kingdom of the Netherlands, is close to an exact copy of the curriculum studied in the Netherlands. This curriculum narrowly focuses on the history of the main-land Netherlands with little to no exploration of history in the Netherlands Antilles, let alone Aruba (Geronimo, 2023). This has caused a rift between the local people and their history. Hence, the Aruban mural movement uses murals in an educational capacity to educate the public on the history of San Nicolaas, the old port that welcomed multiculturalism in Aruba. The murals take different elements of the city’s history and use cultural codes to portray the narratives of Aruban history in an engaging way.



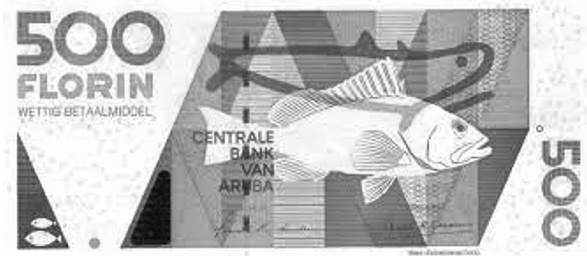

Now you see me now you boat by Juan Vera for Aruba Art Fair (Source: Researcher)

This mural by Juan Vera uses the iconography of the *boto crioyo*, the traditional Aruban fishing boat, that is moulded using a 500 Florin note, the currency of Aruba (Cherouny, 2023). This mural references Aruba's traditional history of fishing which served as the primary economic activity prior to the establishment of an extraverted economy in Aruba. It celebrates a cultural motif symbolic of ingenuity and adaptability in a reminiscent capacity as the skill of making the *boto crioyo* has been lost to time (Rosa, 2023). This mural, like many others, takes these narratives of history and displays them as educational anecdotes that celebrate heritage and in turn shape cultural identity construction.

Methodology

Research Design

In order to research the perceptions the Aruban community have on their cultural identity and the role of murals in representing this, a qualitative community based research centred around the lived experiences of the participants has been implemented. This was facilitated through the use of the photo-voice research method that is a participatory action method (Wang & Burris, 1997; Catalani & Minkler, 2010; Sutton-Brown, 2015). Within this research method, participants use photography as a means to capture their perspectives on specific topics relating to the community. The

photographs are then used as prompts for discussion in hopes to trigger critical dialogue and social change (Wang & Burris, 1997; Catalani & Minkler, 2010; Sutton-Brown, 2015).

As a creative research method, it is ideal for the context of this research as it captures the artistic role that visual language can play in the process of representing culture. Moreover, it is accessible to individuals who may be limited in literacy or verbal skills who are interested in participating (Wang & Burris, 1997). The most imperative choice for implementing this research method is because it is empowering to the participants who are given an active role in the research process as core producers of knowledge. It also ensures ethical considerations as the data is controlled by the participant. This aims to attain rich and detailed data on the perceptions the Aruban community has based on lived experiences rather than imposed by the researcher or external theory (Sutton-Brown, 2015).

The disadvantages of the photo-voice is that is a subjective methods that limits the generalizability of the results to a wider group, however, as a qualitative research, this limitation is recognised but inconsequential (Wang & Burris, 1997). This is due to the nature of the study as a qualitative community based research project that does not aim to make generalisations or eliminate the biases in subjective experiences as this dilutes the potential for attaining a thick description analysis. However, a disadvantage of implementing the photo-voice method in this research is the potential for discomfort to arise in sharing photographs or experiences out of fear of being perceived differently. It is then the role of the researcher to ensure that a safe and comfortable environment is established and maintained throughout the study.

Sample

The sample consists of 15 individuals who identify as Arubans, aged between 18 and 65, who are interested in sharing their perceptions on their cultural identity and the

role of murals in representing it. The choice to welcome participants who identify as Aruban rather than strictly native or generational Arubans serves to not exclude any participants who have adopted the Aruban cultural identity as part of their own. This inclusive approach is representative of the creolised culture of Aruba.

Participants were recruited through convenience sampling based on social interactions such as hitchhiking, social events and volunteering throughout the island. The potential participants were thinned out based on availability to commit to the two part research process of photo-voice as well as questions of feasibility. Hence the first random 15 participants who confirmed availability were chosen as participants for the study.

Data collection

The data collection process involves two phases that are part of the photo-voice research method. In the first phase, the participants are given a set of instructions which asks them to take a photograph of a mural they feel best represents the Aruban cultural identity from their perspective (Appendix 1). They are asked to submit this photograph within a four-day period after receiving the instructions which designates ample time for reflection while ensuring time is used efficiently. In the second phase, the participants are invited to join a focus-group to discuss the data collected in the first phase. The 15 participants are designated into 3 focus groups of 5 participants each, excluding the researcher, determined by their time and date availability. The focus-groups were held in a private and comfortable space that is accessible to all participants and was audio-recorded with consent from the participants. The focus-groups used the photographs taken in the first phase as prompts for discussion on the chosen murals, how it relates to Aruban cultural identity and the roles of murals in representing this. This was followed by an open conversation for comments and reflections relating to the choices of other participants.

The advantage of using a focus-group in opposition to a one-on-one interview succeeding the photography phase is a shift in the power dynamics between the researcher and the participant. Moreover, the juxtaposition of different perceptions is used in the hope to prompt dialogue and encourage meaningful reflection beyond the knowledge and experience of the participant or researcher. This does, unfortunately, increase the potential for discomfort with sharing photographs or experiences as the audience is larger and may threaten confidentiality. Therefore, the participants must all be made aware of the confidentiality clause in their informed consent forms. Additionally, the researcher must actively ensure to the best of their ability that a safe and comfortable space is established and maintained throughout the study.

Data Analysis

The data from the photographs and audio-recordings were transcribed and analysed using thematic analysis. This method of analysis aims to identify the patterns that occur in the data and designate them to themes and categories. This aids in the processing of large amounts of data with a rigorous analysis that aims to root themes within data and supporting statements. This method allows for transparency as there is clarity in the analysis and evaluation of raw data into the themes. Thematic analysis can be criticised as being reductive in aims to oversimplify complex perceptions, however, this method allows for in-depth analysis without compromising the parameters of feasibility for a 10 week research period.

Ethical considerations

This research ensures ethical guidelines for research involving human participants are enforced at every stage. These include obtaining informed consent, protecting confidentiality and actively taking measures to protect the well-being of the participants (Appendix 2). This active

effort can be exemplified by addressing trigger warnings and mediating discussion to minimise/ avoid potential harm to the participants. As an ethnographic study, it is important to ensure the reflexivity of the researcher which will include the reflection of positionality in relation to each stage of the research process.

Reporting of findings

Each of the participants submitted one photograph of a single mural which resulted in 15 murals ranging in subject-matter and location. A majority of the participants chose murals from San Nicolaas (11/15 murals) which is expected as it is the site of the Aruba Art Fair and has many murals to choose from. The other 4 murals were chosen from different areas across the island such as Rancho, Oranjestad and even Arikok National Park. The subject-matter of the murals ranged from flora and fauna and socio-cultural emblems to historical events and members of the community. The participants agreed that the personal connection to the subject matter of the mural further ratified the mural as a representation of their cultural identity as it mirrored their lived experiences and histories. It is important to note that no participant chose the same mural.

The focus-group discussions produced rich data, based on complementary and contrasting opinions relating to the chosen murals and their role in representing Aruban culture. Some participants acknowledged the role murals play in shaping their perceptions of their cultural identity as a source of pride and celebration of heritage. Other participants admit that a lack of awareness on the subject matter of the murals may render them inconsequential beyond aesthetic value. Several participants nodded to the use of murals as a tool to educate the tourists as well as Aruban people on local culture and heritage. This was explicitly suggested as a supplementary tool to the education system in Aruba which neglects to inform students on the history of their island beyond superficial anecdotes.

Discussion of findings

The results of the photovoice research have revealed that while the participants chose murals that best represented Aruban cultural identity based on their subjective experience, there are recurring and overlapping categories. The murals chosen highlight elements such as multiculturalism and indigenous pride that constitute the Aruban cultural identity. They also emphasise the relations between the local community and the island as a habitat, their history and the global economy as factors that contribute to the negotiation of their cultural identity.

The perceptions that the Aruban people have of their cultural identity is largely influenced by their subjective experiences as members within a plural community. Deriving from different ancestries, the characteristic that constitutes the Aruban identity most frequently brought out is **multicultural**. After centuries of exposure to cultural influences that creolised Aruba, there is a unanimous perception that the community is multicultural, boasting over 100 nationalities that coexist on the small island. This recurring theme was more prominent in some of the murals chosen and more subtle in others but the layer of multicultural exchange was present in all murals.



Mural of young children by Nigel Matthew for Aruba Mural Projects

The nature of multicultural exchange is rooted in the personal experiences of each participant who have lived the pluralism on the island in subjective ways. Participant 3 chose the mural of young children by Nigel Matthew as it captures the experience of children celebrating a festival together. Each child is wearing a hat that represents an animal that is important to Aruban culture to represent the diversity of the fauna on the island. Even without colour, it is evident that the children are from different ethnicities yet they are not defined by it. There is an emphasis on the cultural cohesion of the children as the future of Aruba, all raising their flags in collaborative celebration. This mural encapsulates the feeling of Aruban students who come from different backgrounds but find themselves in cultural exchange in schools, religious institutions or even at local festivities. This is exemplified by the “**one** happy island” slogan that celebrates the pluralism that exists on the island as a result of this cultural flexibility. This cultural adaptability represents the changing aspects of Aruban identity towards pluralism.

From a young age, Arubans are taught cultural flexibility, rooted in a history of extraversion, where the community had to adapt to the incoming cultures brought about by industry. After the transition from the *cunucu* lifestyle, a plantation based economy, to a wage based economy, the Aruban community had to adopt extraversion as their economy became reliant on the external world to earn a living. This began with the high demand for skilled labourers to fulfil the demand of the American oil industry which attracted a diverse work-force. Participant 14 chose a mural of two different workers, a refinery worker and an aloe vera farmer, in a loving embrace. This highlights the role of industry in attracting, integrating and assimilating incoming cultures with a warm embrace.



Mural of the San Nicolaas embrace by Chemis for Aruba Art Fair

The mural also highlights the creolisation that came through finding love which could only have happened through the industries that brought together people from other cultures. It is more than a merger of industry, it is a merger of culture. This participant shared their experience with this as a third generation Aruban, with ancestry in Colombia, whose predecessors met because of the oil refinery. It historicised the role of industry within a social context as a site for creolisation and assimilation.

The decline of the oil-industry resulted in the growth of the second largest sector in Aruba, the tourism industry. With tourism came globalisation as the Aruban economy became intertwined with the global market and heavily relied on it for economic stability.



Welcome to Sunrise city, San Nicolas; artist unknown

Participant 11 chose the mural Welcome to Sunrise City because it captures the impact of industry on the Aruban history and culture. As an elderly person in the community, they experienced the transition between the closing of the oil refinery to the building of the hotels and how this impacted the role of the Aruban workforce. Entering the service industry gave the people more economic opportunities but introduced a tourist culture that existed in parallel to the local culture. The local culture became synonymous with service to the tourists as it was necessary for economic survival. The participant chose this mural because it highlights the culture of servitude that has become a prominent feature in the Aruban cultural identity that is extended by a welcoming nature, open mindedness and jolly attitude. This is alluded to in the “one, **happy** island” slogan that celebrates this culture of extraversion.

However, this process of extraversion through industry began earlier than when many believe it did. While many are aware of the impact of the oil industry, the development of other industrial sectors is lost on many. A lack of education on their industrial development has caused a disconnect between the community and their history.



King of the streets by Chemis (Aruba Art Fair)

Participant 8 picked the mural King of the Streets because it captures the industrial history of Aruba and proposes that it aids in a better understanding of the Aruban cultural identity as it proves creolisation through migration even prior to the oil refinery. This mural takes a journey from the traditional economies of fishing (boat on the shirt) and agriculture (traditional farmers hat) to the modernised industry like phosphorus (bat), gold (necklace), aloe vera farming and lastly, the oil industry (pipes beneath the chair). The mural uses cultural codes, emblems, that reference the development in history as markers of significant cultural shifts. Industry brought with it migration of people from across the globe who were in search of economic promise. This began much earlier than migration attributed to the oil refinery, which is taught in Aruban schools. *The King of the Streets* mediates a connection between the modern and the traditional in a cohesive collaboration that pays tribute to the traditional Aruban ways of life, while acknowledging the impact of modernisation on the people.

The connection to traditional Aruban culture is exemplified in the celebration of indigeneity which is an enduring aspect of Aruban cultural identity. The connection to the indigenous peoples of Aruba, the Caquetio Arawak peoples, is a source of cultural pride for many Arubans. Notably, the Amerindian heritage through ancestry appears to be lost in the contemporary Aruban community. However, what remains is the symbolic connection to the indigenous peoples as a way to root their cultural identity within a distinguishable starting point.



Cave painting by Caquetio Arawaks in Arikok National Park

Participant 2 made reference to this indigenous pride by choosing to submit a photograph of the indigenous cave paintings found in Arikok National Park as their mural of choice. Their reasoning for this is that it not only fits within the definition provided of a mural but it also represented the starting point of culture on the island. This indigenous pride serves as a means to make sense of the disruptions of migration and creolisation that have taken place on the island by finding unity in a shared common history. The connection to the indigenous is not only based on shared direct ancestry but paying tribute to the indigenous peoples of the island that has now become home to many other cultural groups.

This is shared through the many traditions that are expressions of Aruban cultural identity which may have found its inception with the indigenous peoples or picked up from incoming cultures but have become a prominent feature nonetheless. An example of this is the rooster which is an animal that plays different roles in the traditions of Aruba. Participant 12 chose a mural depicting a rooster because of the connotations it has to the *cunucu*, traditional, agricultural lifestyle which is emblematic of Aruban history.



Mural of a rooster on the National Library of Aruba; artist unknown

The rooster is also present in other shared practices such as cock-fighting which is another traditional sport and pass-time for the community. The traditional festival, Dera Gai, meaning “to bury the rooster” is centred around the decapitation of a

rooster whose blood would make the earth fertile for the next planting. Dera Gai is a mediation of Christian and Pagan influence as it celebrates St. John the Baptist with other Pagan emblems from the Arawak peoples to highlight the creolisation of religious practices in Aruban traditions.

Aside from the rooster, other local flora and fauna were suggested to be a unifying cultural factor as a clear connection to the island. The love for the island is the very thing that bonds all the members of the cultural identity and is exemplified through the pride in the local flora and fauna that exists on the island. Multiple participants made reference to the endemic species that share the island with the local communities and some went on to speak on the importance of conserving these species as a means to strengthen their ties to the island. Participant 6 chose a mural of the Aruban burrowing owl, or the Shoco as it is commonly known. The *Shoco* is the national bird of Aruba and is a cultural emblem for national pride. An endemic species to Aruba, the Shoco has experienced a threat to their natural habitat by off-road vehicles driven as a tourist activity in the Arikok National park. They elaborated on the species as the Shoco have a strong attachment to their nests that are burrowed in the land as they rarely leave them, according to participant 6 just like Arubans would do.

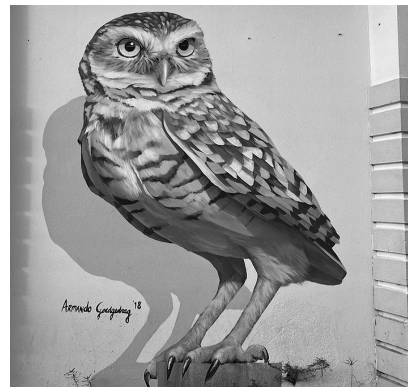

Shoco Owl by Artmando (Aruba Art Fair 2018)

Participants 1 and 9 also made references to beloved animals in Aruban culture, the turtles, as representatives of Aruban people but in very different ways. Turtles within the Aruban culture have come to symbolise different things ranging from the conservation efforts of the people to a delicious traditional dish. Participant 1 chose a mural that shows 3 turtles swimming in different directions to symbolise the different pathways taken by the Aruban people but the coexistence within a bale. These different pathways include the path to Europe, specifically to the Netherlands, which is a popular destination in the pursuit of higher education as Aruba is still a part of the Kingdom of the Netherlands. The characteristic of the turtle that this participant associates with Aruban culture is that despite the different paths that Arubans take, they can still always find their way home like the turtles do.



Mural of migrating turtles by Ice One (extended by Aruba Art Fair)

In contrast to this, participant 9 uses the emblem of migrating turtles to represent the brain drain of Aruban youth who commit their skills to attaining a Dutch way of life at all costs and inevitably losing connection to their land. In this interpretation, as a student geared towards studying in the Netherlands, this participant alluded to the pursuit of a “better” life that is attractive to many Aruban youngsters. This is especially influenced by the educational system instituted in Aruba that prepares the Aruban students for academic life abroad by teaching in Dutch in the higher levels of school. At the promise of a better life

than what is offered on the small island, many leave to find better opportunities resulting in brain drain.



Mural of hyper realistic turtle by Artmando (Aruba Art Fair)

In the group-discussion, the factor that contributed to attracting many emigrated Arubans to return manifested in the sense of community that they feel on the island. This bond transcends superficial differences and is seen in the celebration of the community. Community is the core of the Aruban cultural identity as it represents true cultural flexibility that has been mediated by industrialisation on the island built upon a connection to shared indigenous heritage. The way in which community is represented in the murals is exemplified in the depictions of local community members.

Participant 4 chose a mural of a local quenepa peddler, Aruban fruit, who, although he suffered from drug addiction, was admired for his hustler way of life. The muse of the mural, Sky, was a recognisable member of the community in Rancho and after his passing, the community decided to paint him on a mural in tribute. The participant chose this mural because it represents the struggles that many Arubans face, such as drug abuse, gambling and health problems, and the role of community in mediating the effects. Sky received a lot of help from people in the community who would help him by purchasing his quenepa and offering him support through other means. Participant 4 emphasised that community played the most important role in how they perceived Aruban culture.



Mural of Sky by two local artists in Rancho

This notion was advanced by Participant 15 who chose a mural of a local Aruban musician, Ataniro, known for producing music in the local language of Papiamentu. As an icon of the Aruban community and making music in Papiamentu, the language of his people, Ataniro represents pride in Aruban culture. Papiamentu, an alternative mode of Aruban cultural expression to murals, is a culmination of the creolisation process that has resulted in the unique Aruban culture of today. The palette of the mural uses the colours of the Aruban flag in allusion to this cultural connection to his community. Hence Ataniro's choice to produce music in Papiamentu is seen as a tribute to the Aruban people. He represents the love for the community and the sense of belonging that comes with speaking the language.



Mural of Ataniro by Mr. Lowe (Aruba Art Fair)

The importance of language as a representation of community was brought up by participant 7 who submitted a photograph of the mural with a single word written, *Wekulcha*. According to the participant who had a long history with the city of San Nicolaas, the term is slang in the city for Our Culture. This term represents the creolisation of Aruban culture with San Nicolas as the site of cultural encounters since its role as the main port of the island. San Nicolas was the welcome mat into Aruba during the time of the oil refinery as many came into the island through the port and settled in the city to be close to the refinery. When the oil refinery closed the people stayed in San Nicolaas. *Wekulcha* is a tribute to the different cultural amalgamations that are represented in the San Nicolas community with heritage outside of Aruba but now call the island their home. It celebrates multiculturalism while maintaining Caribbean heritage as a core element of the community's cultural identity.



Wekulcha in San Nicolaas by Rudyomar Leysner for Aruba Mural Projects

This raises an interesting element of the Aruban cultural identity as intersectional on the communal and individual level. The ability to acknowledge each facet of cultural identity expression is welcomed and encouraged within the multicultural arena of relations. Through globalisation, Aruba has become the home to many expatriates who have opted to move to the island and build businesses and eventually a life

there. By doing so, they do not neglect their cultural heritage but rather negotiate the assimilation process into their cultural identity formation in order to belong within the Aruban community. Participant 13 chose a mural that highlights this cultural negotiation by juxtaposing numerous national emblems of other countries, such as flags, in cultural harmony with the emblems of Aruba such as the local flora and fauna.

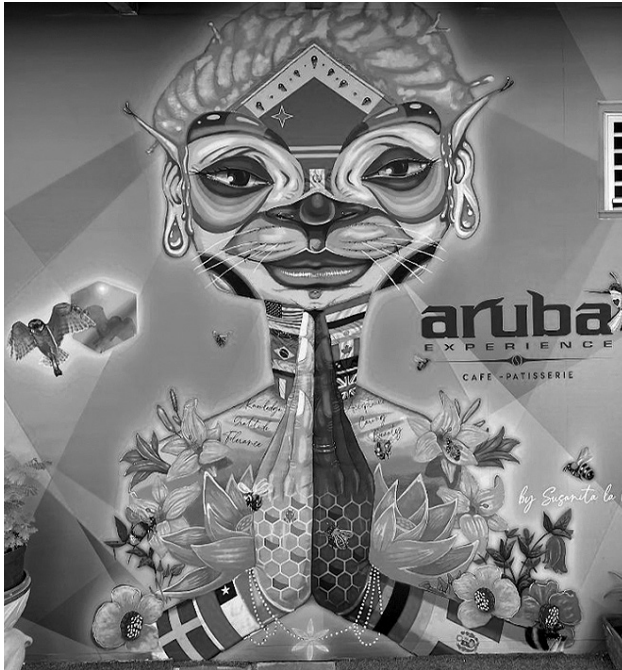

Mural at Aruba Experience, Oranjestad by Susanita La Billa

This mural highlights multiculturalism in a manner that acknowledges the variety of distinctive cultural groups that exist on the island without compromising their value as expressed aspects of cultural identity. This further emphasises the methodological choice to open the research to any participants who identify with the Aruban cultural identity. Within the discussion, this brought about reflection for those

who feel a sense of belonging within the Aruban community yet still have a strong attachment to their heritage and ancestry. This reflection concluded that cultural identity in its multiplicity can be expressed in different ways but does not devalue the other aspects not expressed at the time. The mural highlights that all aspects of cultural identity can be affirmed through coexistence in splendour.

This cultural coexistence is something considered to be an enduring aspect of Aruban cultural identity as the community consists of individuals with subjective experiences and unique backgrounds that are all connected by their love for the island of Aruba. Participant 5 selected a mural that depicts three children with distinctly different ethnicities building a sandcastle that resembles the oil refinery.



Mural of children building a sand oil-refinery by Chemis (Aruba Art Fair)

This mural highlights cultural harmony, beyond coexistence, as an active collaboration to build a future for Aruba. It pays

tribute to the history of collaboration that has creolised the culture and advanced the economic development on the island through the oil refinery.

However, by depicting it in sand, it shows that the future is not set in stone but rather malleable and requires active effort from each child to contribute something worthwhile to the future of Aruba.

A future built by the Aruban youth is one to look forward to when it is infused with the strong values of cultural identity shared by the likes of Tajikah Richardson. Participant 10 chose the mural Tajikah, the very mural referenced at the beginning of this research, for the exact reason that it was used to begin this work. As a dynamic concept, the Aruban cultural identity is subjective to the experiences of each person and the voices that illuminate the negotiation of its complexity deserve to be celebrated. Hence, Tajikah is a representation of this ever-changing understanding of Aruban cultural identity that is influenced by shifting frames of lived experiences. She is a representation of the Aruban cultural identity.

Conclusion

The quest to explore the perceptions that the Aruban community members have on their cultural identity and the role of murals in representing this has resulted in a rich and holistic understanding of characteristics of importance to the community. Murals as tools of representation have proven to be a crucial entry point to deconstructing cultural identity by translating the cultural emblematic codes of the Aruban community into an interpretable visual language. As a cultural outsider, it has provided me with a means to begin to understand the lived experiences and histories of the community without having experienced them for myself. The murals shared by the participants of this study highlight the manner in which subject experience has informed the individual conception of cultural identity which in turn shapes the shared cultural identity.

Grounded in tribute for those who came before, the Aruban

community has built their identity from the foundation of the indigenous peoples who brought the first culture to the island. From then, imperative historical moments, such as industrialisation and globalisation, triggered cross-fertilisation of culture into the unique amalgamation that is expressed today. Within this amalgamated cultural identity are the many layers of cultural existence that coexist. Each individual is in an active role of negotiating these layers based on how they are positioned or how they position themselves. And while at certain times some elements of their identity may take precedence, each layer is imperative to constituting a whole. This highlights the intersectionality that exists within the Aruban community as there are different groups of people who can adopt the cultural identity of Aruba without compromising other aspects of their identity.

Through the representations of the murals, a strong connection is found between the Aruban people and the island, traditions and community. The element of community especially has proven prominent as it illuminates the adaptability to mediate multiculturalism from centuries of creolisation. The negotiation of the Aruban cultural identity is a testament to the cultural flexibility and inclusivity that constitutes oneness on the island. The ability to welcome this change is an enduring aspect of the Aruban identity where the sense of community and belonging is at the core of their culture.

Murals as a mode of expressing the properties of Aruban cultural identity have become a source of cultural pride and intangible cultural artefacts. While the awareness of the Aruban mural movement is still growing, the aim of the murals to (re) educate the locals and tourists has caught on and is making a significant impact. With further collaboration with the local community, such as through school field trips or free virtual mural tours, the murals can become more effective as a didactic tool. By understanding the stories of heritage and empowerment embedded by the murals into their surrounding landscapes, the Aruban community can use the murals as a way to construct, affirm and negotiate their cultural identities further.

Bibliography

- Alofs, L. (2008). The Aruba heritage report. *Aruba's*.
- Barnett, A. (1984). Community murals: The people's art. Cranbury, NJ: Associated University Presses, Inc.
- Catalani, C., & Minkler, M. (2010). Photovoice: A review of the literature in health and public health. *Health education & behavior*, 37(3), 424-451.
- Cherouny, J. (2023). *San Nicolaas Mural Tour*.
- Coelho, J., & Bolivar, O. (2023, February 24). ARTISA & Aruba Art Fair. personal interview.
- Coelho, J., & Geronimo, R. (2023, March 1). Cultural history of Aruba. personal interview.
- Coelho, J., & Rosa, C. (2023, February). Customs and Traditions of Aruba. personal interview.
- Cohen, R. (2007). Creolization and cultural globalization: The soft sounds of fugitive power. *Globalizations*, 4(3), 369-384.
- Escorteganha, M. R., Santiago, A. G., Magosso, H. A., Richter, F. A. & Costa T. G. (2013). Conservation state of mural paintings from a historic house in Florianópolis-SC, Brazil: A multidisciplinary approach. *International Journal of Conservation Science*, 4(1), 13-24.
- German, P. (2003). interview.
- Hall, S. (1997). The work of representation. In *The applied theatre reader* (pp. 74-76). Routledge.
- Hall, S. (1990). Cultural Identity and Diaspora. In *Colonial discourse and post-colonial theory* (pp. 392-403). Routledge.
- Heidenry, R. (2014). The murals of El Salvador: Reconstruction, historical memory and whitewashing. *Public Art Dialogue*, 4(1), 122-145.
- Cultural Communication. (2014, September 8). *Cultural identity theory*. Communication Theory. Retrieved from <https://www.communicationtheory.org/cultural-identity-theory/#comment-20523>
- Lettieri, M., & Tanguma, L. (2001). Cultural identity and ethnic dignity in Chicano mural art: An interview with Leo Tanguma. *Confluencia*, 136-146.
- Moss, K. L. (2010). Cultural representation in Philadelphia murals: Images of resistance and sites of identity negotiation. *Western Journal of Communication*, 74(4), 372-395.
- Razak, V. (1995). Culture under construction: The future of native Arubian identity. *Futures*, 27(4), 447-459.
- Sadatiseyedmahalleh, S., Suraiyati R. & Aldrin A. (2015) Critical review on the role of street art of Georgetown, Pulau Pinang. *Advances in Environmental Biology*, 9(4), 181-184.
- Sutton-Brown, C. A. (2014). Photovoice: A methodological guide. *Photography and Culture*, 7(2), 169-185.
- Poon, S. F. (2016). Street murals as a unique tangible cultural heritage: A case study of artifact value preservation. *International Journal of Cultural and Creative Industries*, 4(1), 48-61.
- Wang, C., & Burris, M. A. (1997). Photovoice: Concept, methodology, and use for participatory needs assessment. *Health education & behavior*, 24(3), 369-387.
- Woodward, K. (Ed.). (1997). Identity and difference: Culture, media, and identities. Thousand Oaks, CA: Sage.

Elizabeth van Hofwegen, University of Aruba



SISSTEM in my System.

Since the Faculty of SISSTEM in Aruba caught my eye in 2018, I was very interested in this field. For students with beta subjects, apart for the Faculty of Mathematics, there were not many opportunities for further study after high school in Aruba at the time. It is a blessing that this study is realized on our island in collaboration with KU Leuven.

SISSTEM is very all-rounded and one learns a lot in a short time. What one studies does not only stick to theory, but can often be applied directly in the real world. The topics concern problems and situations that thousands of scientists, governments and people from different sectors of society are looking for solutions to. These are issues that often require urgent solutions with the looming background of climate change and all its consequences.

We stay up to date with the latest developments through guest lecturers with an expert presentation or we meet guests of UNICEF for example. It always remains a pleasant

surprise, but who would have thought that the world is more or less coming to Aruba now?

Issues that increasingly regularly enter our homes via TV images and other media, like catastrophes, such as floods, hurricanes, forest fires where one normally watches helplessly, now might be part of this fascinating study, where one can possibly contribute to future occurrences.

To know that you can actually do something to improve world problems is, to say the least, intriguing, but first start locally, where it is becoming increasingly clear that a lot needs to be done in the field of environmental action.

The theory is a lot and necessary, but its direct application is very motivating and empowering. The fact that you can participate in biological research in the form of diving and do real research on the seabed, during your studies, gives you the feeling that you are already engaged in the profession.

Very nice is that in between studying there are also educational, but extremely fun bus trips, field trips and the like, which alternate the lectures. In this way, you get to know and explore your island well and you know where the bottlenecks are that you can work on in your studies. You learn to see your island from a completely different perspective. You are curious where this path that you have embarked on, will eventually lead in the light of your new study.

If you suddenly find yourself in a class full of international and multidisciplinary students, where you learn a lot from

each other in a pleasant way, you imagine yourself abroad in an international exchange program: an unexpected and unique experience. Through the fun events in between, such as the cookout at the home of the boss himself, everyone gets to know each other in a casual way, almost in a holiday atmosphere.

A heartfelt thank you goes out to Dr. Eric Mijts, who warmly welcomes and continues to support everyone and who is the engine of SISSTEM. He creates a unique educational setting in a cordial atmosphere that greatly benefits the students. So yes, I can warmly recommend SISSTEM to everyone.



Vegetation as Insulation

Elizabeth van Hofwegen

Abstract

Rediscovery of the unique and completely sustainable way of designing buildings of the Aruban designer Mr. Francisco (Chico) Dijkhoff, very well known in Aruba in his time, was crucial for this research. On every street or corner of Aruba there are many houses from his drawing board. His houses are cool without air conditioning unless people change them.

Thanks to the insight of Mr. Francisco (Chico) Dijkhoff who in all his designs built on the traditional Aruban building principles of the traditional Cunucu House, and thanks to the fact that numerous Aruban houses come from his drawing board, there is now a large stock of sustainable houses. Many houses of this large collection are approaching the end of their life cycle. For this treasured large collection, circular renovation can guarantee to continue to preserve their valuable traditional building principles, and their sustainability, as is the case with post-war houses in the Netherlands (Maastricht City Deal).

For other houses that need air conditioning (A/C), a circular solution for insulation was devised and investigated through this research.

This research paper is relevant in solving the important architectural problem to insulation in a circular and affordable way with Vegetation as Insulation. Insulation material is a part of the large construction waste, that

causes emissions of CO₂ and other toxic substances when combusted in the landfill, causing global warming and climate change. It is time for Aruba to tackle the problem of construction waste in a circular way.

The result of this study, renders a partial reduction of the large waste stream for building materials.

At the same time, Vegetation as Insulation offers a solution to ecological and social issues, such as food security that play a role in Aruba, as a Small Island Developing State (SIDS).

Furthermore, this circular and affordable insulation, is the perfect solution to drastically reduce the utility bills for electricity, where A/C is the largest user in the home (Elmar, 2023).

Moreover, by reintroducing the tradition of maintaining the own garden, this report also shows the importance of being prepared for times of crisis, such as during COVID, where most Arubans suddenly became unemployed, while still dependent on the expensive import of products.

In summary, with this circular research solution of Vegetation as Insulation, Arubans can cool their homes, while producing fruits and vegetables in their garden, both in an affordable way. Additionally, Aruba will be able to comply partly with its commitment as a member of the United Nations (UN).

The methods used in this research involve desktop research, literature study, and interviews.

In conclusion, with the circular solution to an architectural

problem to insulation, other important issues of Aruba are also partly resolved.

Introduction

The Situation

As a Small Island Developing State (SIDS), Aruba experiences the same problems as other islands. SIDS are in relative isolation, because they do not border on other countries. As a result, they depend on expensive imports for most products, while their economies tend not to be strong. Additionally, many islands have only one economic pillar; for Aruba, that is tourism. Although SIDS often have a small population, they nevertheless have a high population density due to their small surface area. They often lack the manpower needed for a strong economy and often do not have raw materials (United Nations, n.d.).

The Problem

In Aruba, a small island in the South of the Caribbean Sea, the climate is hot, and according to prognoses (UN, 2015), it will get warmer. Fossil fuels besides that they emit CO₂, they will become increasingly unsustainable. Aruba faces the challenge of taking steps quickly, especially, because it is for the most part dependent on non-renewable fuels. Air conditioning (A/C) is already not affordable for many households, as the largest user of energy in the home (CBS Aruba, 2010), (Elmar, 2023). There must be a more affordable alternative for the use of air conditioning for cooling for peoples houses. This problem of affordable circular cooling is the focus of this research. Circularity is based on the principles ‘make, use, and reuse’.

Top Quality Circular Insulation

According to the website, Isolatienuoord (n.d.), ‘Metisse Katoenisolatie’ is an ecological and affordable insulation. It is a 100% natural and fully circular insulation material, made from old non-reusable cotton clothing. It serves as both thermal and sound insulation with a moisture control

effect and an optimal heat storage capacity, making it suitable in hot and cold weather.

The old cotton clothing is torn up and processed into small fibers, after which they are washed and treated with a product that makes the cotton fire and mold resistant. A binder is added and the cotton is heated to 100 degrees Celsius. As a result, it merges into a flexible shape-retaining piece of cotton insulation that is then processed into insulation boards, acoustic plates and into insulation rolls that consist of 90% recycled cotton fibers. It regulates moisture and contributes to a comfortable and healthy living environment.

How does it work at high temperatures? It has a high heat storage capacity. This means that the insulation material can store the heat at high temperatures. The more heat, the longer it takes for the heat to penetrate the material. This ensures that a space insulated with cotton stays cool longer in the summer. Compared to traditional insulation materials, this quickly saves 6 to 7 degrees in temperature.

What is the Rd value (insulation value) of cotton? That depends on the thickness, but cotton insulation is comparable to rockwool or glass wool from the Rockwell brand, which counts as one of the best, if not the best insulation material. However, the cotton insulation is quite pricey, especially if it has to be transported to Aruba, which is not financially feasible for people with a lower income. Therefore, research is necessary for an affordable alternative.

Research Questions

The starting point of this paper is circularity in the construction world. One of the problems of SIDS and also in Aruba is the huge problem of waste streams. Especially because Aruba has a high population density and millions of tourists visit Aruba every year. Moreover, the only

landfill, ‘Parkietenbos’, has been overfull for years and causes nuisance to the neighborhood (Gobierno Aruba, n.d.). In 2022, the minister in charge announced that the decision had been taken to close it.

Construction creates a high percentage of waste in most countries. When combusted, old building materials emit many fumes that are very dangerous to the environment. Therefore, it is important to prevent them from ending up in the landfill, and solutions must be found to prevent this from happening. Ideally, these solutions should be financially feasible for the different parties concerned. If one or two problems can be solved at once, that would be a better option.

Buildings, especially houses, can be difficult and expensive to change. Reintroducing the tradition of maintaining a garden, preferably in combination with, for example, growing fruit, vegetables and herbs, solves the problem of rising prices for these basic necessities and can possibly be an affordable circular solution for insulation material since the vegetation provides for shade.

The main question of this research is therefore: ***‘Is vegetation as insulation on walls a circular option?’***

The sub-questions are:

1. ***What are the benefits of vegetation in general?***
2. ***What are the advantages of vegetation near buildings?***
3. ***Can vegetation serve as a sound barrier?***
4. ***What are factors to take into consideration regarding vegetation (on walls)?***

The answers of the sub-questions lead to the final answer of the main question.

1. ***What are the Benefits of Vegetation in General?***

In general, vegetation offers numerous economic, technical and sustainable benefits. Many websites, often by plant experts, provide information about the benefits of plants. According to one of them, Flora News (2022):

- Green façades are protected from the radiation of the sun, because 70% of the solar radiation is used by the plants for photosynthesis.
- The underlying façade remains better protected and requires less maintenance, because the wall is not directly exposed to external influences. Maintenance is necessary only after an average of ten years.
- Due to the greenery, there is better air quality, because more particulate matter is filtered through the air.
- In addition, plants release oxygen, which contributes to better air quality and health.
- As for biodiversity, in a green façade birds can nest and it is a good habitat for insects, such as bees and butterflies.
- A vertical green façade does not need much space: plants in hanging pots, climbing plants on the wall or on a trellis.
- Green facades reduce the temperature that is 7 degrees Celsius cooler compared to a stone façade on hot days.
- Plants are good for the environment, because they work as a biofilter: they bind CO₂, absorb particulate matter and ensure cleaning of rainwater.
- As for the temperature and insulation, the green façade does not heat up and water evaporates. This significantly reduces the heat load. Therefore, the green façade insulates, leading to considerable energy savings, since an A/C becomes superfluous.

2. ***What are the Advantages of Vegetation Near Buildings?***

The Advantages of Vegetation Near Buildings

According to Armson et al. (2012), compared to concrete, grass can lower the surface temperature by 24%. Through extra evaporation, vegetation ensures that less solar radiation changes into stored heat, and as a result, there is less warming of the air. This evaporation is strongest during the day, and therefore, less heat is stored, causing the environment to be less warm at night.

Trees provide cooling through evaporation and shade.

Vegetation as Insulation

A well-known phenomenon in Aruba is that for hours in the evening, it is warmer indoors than outdoors. This is due to the fact that the exterior walls have been exposed to the sun's rays for hours. The walls retain the heat (heat accumulation) and radiate their heat inwards the house.

Trees, shrubs, and green façades can cool the surface temperature up to 15.5 degrees Celsius on the outer walls and 1.7 degrees Celsius on the inner walls. The advantage of cooler façades is that they radiate less heat and that they contribute to a comfortable environment (Hoelscher, et al., 2016). A wall that is covered by a dense layer of leaves, prevent the sun's rays from reaching the wall, and thus functions as insulation.

Vegetation Provides Cooling

According to Encyclopædia Britannica, inc. (n.d.), wind chill/ windchill/ wind chill factor/ wind chill temperature or wind chill, they are all equivalent. They have to do with the fact that as the wind speed increases, the heat loss of the body also increases. This makes air "feel" colder. According to Hiemstra (n.d.) in his article on Wageningen University & Research, where Professor Dr. Ir. J. Kluck is quoted, wind chill is the 'gevoelstemperatuur', this is the temperature a person experiences/ feels and they state that this is equivalent to PET. According to Klok et al. (2019), PET is the Physiological Equivalent Temperature, which is equal to wind chill.

According to Klok et al. (2019), wind chill can be significantly reduced by shade: a single tree can already provide localized cooling of 12 to 22 degrees Celsius. So, providing shade is the best way to bring down the wind chill. Wind chill is the temperature that is experienced and this may differ from the actual temperature. Dr. Ir. L. Klok is an expert on this topic and she studies the possibilities on how to cope with heat waves in The Netherlands.

During the day, there is more or less shade, and before planting a tree, it is important to choose its spot strategically in order for the tree to give shade where it is most needed.

If there is a cool breeze, it already feels a lot cooler, while the actual temperature remains the same. A little bit of wind already provides coolness, especially in combination with shade (e.g., an overhang) and vegetation. However, since wind directly affects the wind chill: it is the cooling effect of the wind, it is of the essence to ensure that the vegetation does not block the wind.

Under the trees, it is always cooler, even at times when there is no shadow. This fact is due to the low surface temperature and because the surfaces that were previously in the shade, radiate less heat.

When choosing greenery, it is important to take into account the species for a better choice for these advantages. Plant experts at the Santa Rosa Department of Agriculture, Livestock, Fisheries and Farmers Market, and specialized plant stores are happy to advise on this.

3. *Can Vegetation Serve as a Sound Barrier?*

Gaudon et al. (2022) conducted a study to investigate the effect of roadside vegetation to determine whether there is noise reduction from road traffic. Their research found that vegetation greatly reduced high frequencies.

Zhu et al. (2010) compared six species of evergreens on different variables. The result shows that there is a noticeable difference in noise-canceling effects for low frequency and high frequency ($p < 0.5$) when the plants are arranged differently.

According to van Leeuwen (2016), a 6 m wide and 5 m high strip of bamboo as a sound barrier is comparable to a 3 m high solid noise barrier.

According to Arch20 (2010), vegetation, especially nearby schools or other crowded places, can serve as sound barriers.

The studies consulted, indicate that the leaves of plants absorb sound, but how much, depends on different factors. There are many factors at play, such as the species, the type of leaf, etc. and there is not much research on this.

The sub-question 3: ‘Can Vegetation Serve as a Sound Barrier?’, is answered by this information. This outcome brings a relevant benefit for Aruba, since on Aruba many people live in small apartments close to each other and privacy is much appreciated: they can use plants to decrease the noise from outside, like that of traffic and people.

4. *What are Factors to Take into Consideration Regarding Vegetation (on Walls)?*

The Influence of Temperature Indoor and Outdoors

As mentioned before, it is important to take into consideration factors regarding vegetation in general, or vegetation on walls. The temperature indoors and outdoors and vegetation around a building, or vegetation on the walls, play a significant role, especially when it is very cold, or hot like on Aruba.

When it is very hot, more people die according to the international news in the media. Especially the elderly and also people suffering from high blood pressure, for instance. Due to the heat, people cannot sleep well without cooling. In Aruba, the financial situation has worsened after COVID for the group that already could not afford air conditioning. A circular solution that is affordable for the current and the future situation, would provide considerable monthly savings for this group.

As a consequence, it is of the essence to ensure that buildings are as cool as possible inside, but take also into account that the outdoor space near the home also affects the indoor temperature. Much is known about the indoor temperature of houses, but not much is known about the influence of the outside temperature on the indoor climate.

Therefore, this study is important, as it tries to find a circular solution in the outdoor area, thus making the use of air conditioning redundant. The concept of wind chill, plays an important role in this research, and so do four principles for lowering wind chill.

Wind Chill

According to Klok et al. (2019), in the same city the difference in the temperature that is experienced (the wind chill) between different places can be about 12 to 22 degrees Celsius. This difference is caused by the absence of shade, too much heat emission of certain materials or too much reflection of solar radiation through glass windows or façades and light-colored surfaces.

In Aruba, for example the temperature is experienced as warmer, because of the average high humidity of 74.0% (Meteorologische Dienst Aruba, 2021). This is due to the fact that less sweat can escape and therefore less heat goes through the skin. However, good ventilation guarantees that the body can get rid of the heat more efficiently and this ensures that one feels the heat less.

Four Principles for Lowering Air Temperature

According to J. Kluck, et al. (2018), lowering the air temperature is based on four principles: evaporation, shading, ventilation and reflection.

With evaporation, there is a decrease in latent heat, and this leaves less energy for heating air and surface. The leaves of vegetation take care of

evaporation of water with the heat.

Shading ensures the capture of solar radiation and therefore limits the amount of energy on the shaded surface: trees provide shade.

Reflection reduces the available energy that heats up. The dense foliage of plants on a wall prevents the sun rays from reaching the wall. Ventilation ensures the removal of warm air: therefore, avoid vegetation on a spot that prevents the wind from bringing fresh air into the building.

The Influence of Temperature on the Human Body

These parameters are also important in the human body, because they determine how hot or cold the environment feels.

Shading and ventilation can reduce the perceived temperature. According to Shahidan, et al. (2010), on a hot

day the maximum incoming solar radiation can reach 1000 Wm², but in the shade this radiation is 10 times smaller, which means that there is ten times less energy to heat our body, making it feel cooler, because just outside of the shade is the real temperature.

Because the wind provides the heat exchange between body and environment, it provides cooling. The body is often warmer than the air temperature. Consequently, a higher wind speed causes a decrease in body temperature.

Evaporation not only cools the air, but can also be used to lower the perceived temperature: when water evaporates from the skin, the temperature feels lower.

Shade can lower incoming sun rays ten times, leaving ten times less solar energy for the temperature of the surface under a tree. As a result, the skin of a person under that tree heats up ten times less. According to Klok et al. (2019), the wind chill can differ 12 to 22 degrees Celsius between a spot in the sun and a spot in the shade. Of all these four parameters, shade is the best way to reduce the wind chill.

In addition, shade from vegetation is a very affordable way of cooling, especially when choosing indigenous vegetation, that is resistant to drought and therefore requires little water.

When designing a garden, or another outdoor space, these are the parameters to take into account, as is the case as well with vegetation as insulation on the outer walls of a building.

The result is that with these findings, the main research question 'Is vegetation as insulation on walls a circular option?', has been completely answered.

Methods

Since not much is known about the heat resistance of the outdoor space, this study works with the available literature and visions, as hard standards of temperature are difficult

to control or achievable. Desktop research and literature review has been used.

In connection with the climate change that causes a lot of discomfort, especially in big cities during heat waves, the urgent need for solutions arose, leading to the motivation to start research about the heat resistance of the outdoor space.

For this research, different people were interviewed for different purposes. They are all anonymous.

For this study, it was important how people experienced and remember the indoor temperature of different types of Aruban homes. There are five people in every age range of 65-75 years; 55-65 years and 45-55 years interviewed.

The result was as follows. All interviewees of category I-III have been in the first four types of houses. Their close relatives or friends lived or they themselves still live in these types of homes. They remembered that all four of them are cool inside. None of them have been in modern cubed shaped houses.

The interviewees are people who happened to be walking the street. Their age has been estimated, because in Aruba it is not appropriate to ask people about their age. The fifteen people interviewed are eight men and seven women, and the interview sheet is on the next page.

These results served the part about the houses of the Aruban designer Mr. Francisco (Chico) Dijkhoff.

For information about the L-houses, Dijkhoff houses (my naming) and other designs of his drawing board, I interviewed a close relative of the late Mr. Francisco (Chico) Dijkhoff, who explained the basic principles of his designs, and showed me a lot of his designs. The houses are indeed designed in such a way that they are cool inside without air conditioning, entirely according to the principles of the traditional 'Cunucu House', and Mr. Dijkhoff came up with new solutions for the modern houses of his time to meet these principles. This interview gave a lot of insight in designing sustainably.

As the history of Aruba has not been recorded, I interviewed someone who in the last century had a key position in the government for making decisions regarding preparing Aruba for tourism after the closure of the LAGO.

Since Aruba at the time had solely one economic pillar, the oil refinery, and now tourism, the way a solution was found, can teach people how to be creative when an economic crisis surges, and what they can learn about this in order to be better prepared.

For information about the traditions and customs of the past, especially with regard to agriculture, horticulture, animal husbandry and lifestyle, I interviewed three people aged seventy to around eighty years old. They talked between half an hour and three quarters of an hour. After several church services, I approached them and they were willing to cooperate. The stories matched those of older close relatives and acquaintances and what one can see on television over time.

As one can learn a lot from people who rely on their common sense, and in doing so successfully survived in times of crisis, their stories and information are very insightful. Moreover, the interviewees described a time where people were very creative and lived in harmony with each other, while sharing and caring. For example, they showed their visitors and their neighbors their garden, and these never left empty handed.

A few years ago, someone from Santa Rosa Department gave me information, in the absence of the actual person who normally is in charge. Due to lack of time, I could not visit for this research, but it is important that people know that they can get specific information about indigenous plants there, including about their care, how high and wide they become, how deep or wide their roots grow, and the like. One can buy indigenous plants at a very reasonable price there.

The fieldwork consisted of observations of houses and taking photographs.

Interview about Opinion Indoor Temperature and Aesthetics of House



1. Have you ever been in a 'Cunucu House'?
2. Is the temperature inside:
A. cool / B. normal / C. hot
3. Do you think this is a beautiful house?
A. Yes / B. Average looking / C. No



1. Have you ever been in a Fifties' house?
2. Is the temperature inside:
A. cool / B. normal / C. hot
3. Do you think this is a beautiful house?
A. Yes / B. Average looking / C. No



1. Have you ever been in an L-house?
2. Is the temperature inside:
A. cool / B. normal / C. hot
3. Do you think this is a beautiful house?
A. Yes / B. Average looking / C. No



1. Have you ever been in a cube house?
2. Is the temperature inside:
A. cool / B. normal / C. hot
3. Do you think this is a beautiful house?
A. Yes / B. Average looking / C. No



1. Have you ever been in a Dijkhoff House?
2. Is the temperature inside:
A. cool / B. normal / C. hot
3. Do you think this is a beautiful house?
A. Yes / B. Average looking / C. No

Results

One important learning outcome of this research is that centuries of traditional construction methods have proven that experience is a good learning tool. In all harsh climates, buildings are completely adapted to the circumstances with knowledge passed down from generation to generation.

Aruba used to have traditionally very sustainable houses, named 'Cunucu Houses'. This same type of 'Cunucu Houses' can be found on other Caribbean islands as well, but they were not designed with the wind and sun direction in mind, unlike the Aruban 'Cunucu Houses', which led to very cool, thus sustainable houses according to Rosenstand (1986), in his master thesis for TU Delft.

With the advent of modern times in Aruba, the principles of traditional construction have been disregarded, while they only bring benefits, since they provided sustainable homes: they were already cool without air conditioning.

Fortunately, the Aruban designer Mr. Francisco (Chico) Dijkhoff did not allow himself to be entirely dragged into

the modern progress of his time. He designed his houses as sustainably as the traditional constructions, along with the application of new building materials and construction methods of his time. Additionally, he also came up with other solutions to keep his designs sustainable. As a result, Aruba has a large stock of sustainable homes, and a part of them are reaching the end of their life cycle after more than fifty years.



Aruba, as a member of the UN agreement of 2015, and following in the footsteps of the Netherlands, which renovates its post-war houses in a circular way (e.g., Maastricht City Deal), would do well to ensure that this large collection of houses from Mr. Dijkhoff's drawing board, are renovated circularly, too. Moreover, people find them beautiful and therefore rather renovate

them than demolish them, as the nicely renovated examples in the photos show.

Unfortunately, over time, some of these houses have been given an extension or for example, façade openings have been bricked up; these changes sometimes make them needlessly hot. The houses of Mr. Francisco Dijkhoff that have been changed, causing them to cease being cool without A/C, for these houses and the houses of other designers that are not designed with sustainability in mind,

and therefore need A/C, the best way to solve the heat problem is by installing insulation.



Mr. Francisco (Chico) Dijkhoff's home

In the knowledge that a good deal of the houses in Aruba are designed by Mr. Francisco (Chico) Dijkhoff and therefore they are cool without air conditioning, and knowing that Vegetation as Insulation is affordable and effective, and that at the same time it solves other important problems, it seems logical to choose Vegetation as Insulation. Especially for the rest of the houses that are not cool without air conditioning.

Discussion

For SIDS like Aruba, circularity seems to be the solution to many problems that islands experience. If we do not take action, the future is nevertheless approaching and it will be too late to solve a number of problems. That is not fair to the future generation that is then deprived of the opportunity to adjust or tackle the problem in time.

First of all, in Aruba, as everywhere else, construction takes up a large part of the waste, like in the Netherlands for example, this is 23.5% (CBS Nederland, 2019). Small Island Developing States often already have to deal with

landfills. Partly, because of the scarcity of land on an island. The idea of the solution of vegetation as insulation is an example of a circular solution to this waste problem, where every reduction of waste counts, because this solution keeps insulation material from going to the landfill at the end of its life cycle.

Secondly, it is known that there are good circular solutions now for insulating buildings. However, if insulation material has to be imported on an island like Aruba, it becomes too expensive for many Arubans, who are more financially depleted after COVID.

Moreover, it turned out that this is a fairly large group that already has difficulty paying the costs of the expensive air conditioning, for according to CBS Aruba (2016), there are many families of single parents with a minimum income or less. This target group does not have the means to buy expensive insulation for cooling for their dwellings.

Furthermore, with the expected increase in temperature due to climate change, the need for cooling will rise. Why not come up with affordable circular solutions for this vulnerable group, for vegetation can be grown from seeds and there is no need for much water if it is only for a small number of plants for a family.

In the knowledge that it has already been experienced that in moments of crisis and with the impending disasters of climate change in sight, there are large groups of people who have no financial leeway if they suddenly find themselves in a helpless and hopeless situation. It is therefore unfair not to look for affordable solutions in advance. Thus, that these people in need can have the possibility to build up a back door ahead with which they can get on top of a crisis, relatively more quickly. Especially on SIDS where people have nowhere to go in times of need, this is important. Everyone is grateful for food parcels and clothing and the like in an emergency, but what happens next?

The question then arises, with whom the responsibility for solving issues such as this or, as here, issues in construction, begins. Some will think that the architects, and the engineers should start, others think that the responsibility lies with the government. However, important is, that someone starts. The concept of this study could serve as a basis for further research, where affordable circular solutions are sought with the focus on financially weaker groups on SIDS such as Aruba.

Conclusion

The positive answer to the main question of this study: 'Is vegetation as insulation on walls a circular option?', makes it possible to offer an affordable circular insulation solution for cooling through vegetation, which significantly reduces the expensive electricity bill for air conditioning.

The solution offered by this study makes the use of air conditioning optional. There will still be people who want to use the air conditioning when sleeping, because for example they work night shifts or for more privacy or for security reasons.

In the expectation that climate change causes the temperature to rise, and due to the scarcity of fossil fuels, the prices for electricity will increase. With this in mind, this affordable circular solution for cooling, which anticipates the future situation, is an outcome for especially people with a lower income.

Since Aruba, as a member of the UN, must start taking measures in line with the agreements for 2030, the circular solution of vegetation as insulation contributes to the reduction of CO₂ emissions, by preventing insulation from being burned at the end of their life cycle. In addition, more greenery also reduces carbon dioxide emissions.

The waste that is released from a small garden is organic and can be used for compost, for example.

On most SIDS, the greater part of the goods must be imported. Shipping makes them extra expensive. Vegetables, fruit and herbs are also imported into Aruba. One reason that many Arubans no longer consume them is, among others, because they are too expensive. The proposed solution increases food security.

The lack of land availability for fruits, vegetables and herbs no longer plays a role, as one's own backyard, or even a wall indoors or outdoors with vertical farming, provides enough products for a family.

This also introduces a healthier diet, so that diseases of affluence such as diabetes can be reduced.

The garden also makes it necessary to move more when you maintain it, which also benefits health.

The water is expensive in Aruba, but a small garden does not require much water. Rainwater can be collected in a container via a gutter and used for watering the garden. In the long run, the yield of the garden's produce compensates for the investment of the gutter and the container.

Finally, more plants provide habitat for many species, which ensures greater biodiversity. More greenery ensures a comfortable wind chill and a more beautiful Aruba.

All these aspects show in the direction of a circular approach. By answering the main question, circular solutions have also been found for other problems that play a role in a community, such as in Aruba. This result is more than planned and expected for.

Recommendation

This research shows that it is possible to find an inexpensive circular solution to a construction problem.

Finally, at the beginning of this research it was not known that this affordable circular building solution would tackle several hot items at the same time, but in

the knowledge that this is a possibility, why not draw the attention of others, so that from now on this will be pursued if possible?

References

- *Air Conditioning*. N.V. Elmar aruba. (n.d.). Retrieved March 28, 2023, from <https://www.elmar.aw/save-energy/air-conditioning>
- Arch2O. (2022, June 20). *FIU School of International and Public Affairs: Architectonica*. Arch2O.com. Retrieved March 24, 2023, from <https://www.arch2o.com/fiu-school-of-international-and-public-affairs-architectonica/>
- Armson, D. (2012). *The effect of tree shade and grass on surface and globe temperatures in an urban area*. *Urban Forestry & Urban Greening*.
- Centraal Bureau voor de Statistiek. (2019, November 3). *Meeste afval en Hergebruik Materialen in bouwsector*. Centraal Bureau voor de Statistiek. Retrieved March 31, 2023, from <https://www.cbs.nl/nl-nl/nieuws/2019/45/meeste-afval-en-hergebruik-materialen-in-bouwsector#:~:text=Bijna%20een%20kwart%20van%20alle,was%20dat%20bijna%2011%20procent>.
- Central Bureau of Statistics *Quarterly Demographic Bulletin*. Central Bureau of Statistics Aruba. (2022, June 16). Retrieved March 29, 2023, from <https://cbs.aw/wp/>
- Encyclopædia Britannica, inc. (n.d.). *Wind Chill*. Encyclopædia Britannica. Retrieved May 6, 2023, from <https://www.britannica.com/science/wind-chill>
- Gaudon, J. M., McTavish, M. J., Hamberg, J., Cray, H. A., & Murphy, S. D. (2022). *Noise attenuation varies by interactions of land cover and season in an urban/peri-urban landscape*. *Urban ecosystems*. Retrieved March 27, 2023, from <https://www.ncbi.nlm.nih.gov/pmc/articles/PMC8761103/>
- *Groene gevels en Daken must voor Koelere Steden*. FloraNews.com. (n.d.). Retrieved March 29, 2023, from https://floranews.com/nieuws/18840/Groene_gevels_en_daken_must_voor_koelere_steden.html
- *Hiemstra, J. (n.d.). Groen in De Stad Klimaat en temperatuur*. Wageningen University & Research. Retrieved May 6, 2023, from <https://edepot.wur.nl/460543>
- Hoelscher, M., Perini, K., Lindroth, A., Hunter, A. M., Cameron, R. W. F., Koyama, T., Ip, K., Mazzali, U., Wong, N. H., Susorova, I., Stec, W. J., Pérez, G., Bowler, D. E., Gabriel, K. M. A., Sham, J. F. C., Takebayashi, H., & Arnfield, A. J. (2016, February 15). *Quantifying cooling effects of facade greening: Shading, transpiration and insulation*. *Energy and Buildings*. Retrieved March 25, 2023, from <https://www.sciencedirect.com/science/article/abs/pii/S0378778815300761?via%3Dihub>
- *Income and expenditure survey 2016 - central bureau of statistics*. CBS Aruba. (2016). Retrieved March 26, 2023, from <https://cbs.aw/wp/wp-content/uploads/2019/04/Unda-mi-placa-ta-bai-2016.pdf>
- *Katoen Isolatie: Ecologisch & Milieuvriendelijk Isoleren*. Isolatienoord. (n.d.). Retrieved March 26, 2023, from <https://isolatienoord.nl/ecologische-isolatie/katoen-isolatie>
- Klok, L., Rood, N., Kluck, J., & Kleerekoper, L. (2019, November 4). *Assessment of thermally comfortable urban spaces in Amsterdam during hot summer days - international journal of Biometeorology*. SpringerLink. Retrieved March 23, 2023, from <https://link.springer.com/article/10.1007/s00484-018-1644-x>
- Kluck, J., Loeve, R., Bakker, W., Kleerekoper, L., Rouvoet, M., Wentink, R., Viscaal, J., Klok, L., & Boogaard, F. (2018). *The climate is right up your street*. Research programme Urban Technology. Retrieved March 23, 2023, from https://klimaataadaptatienederland.nl/publish/pages/119885/book_of_showcases.pdf
- Meteorologische Dienst Aruba. (2021). *METEOROLOGISCHE DIENST ARUBA SUMMARY CLIMATOLOGICAL DATA 2021*. Meteo.aw. Retrieved March 31, 2023, from <http://www.meteo.aw/files/Download/2021.pdf>
- Overheid, A. (2019, May 27). *Parkietenbos*. Vuil stortplaats - Wonen en woonomgeving (subthema's)

- Informatie Dienstverlening - Aruba Overheid. Retrieved March 26, 2023, from https://www.overheid.aw/informatie-dienstverlening/wonen-en-woonomgeving-subthemas_46949/item/parkietenbos_37162.html
- Rosenstand, A.S. (1986). *Het Arubaanse Kunukuhuis, bouwwijze en typische eigenschappen*, (Eindscripctie TU Delft 1986). Retrieved April 22, 2023, from <https://archive.org/details/BNADIGARUBIANA3200>
- Shahidan, M. F., (2010). *A comparison of Mesua ferrea L. and Hura crepitans L. for shade creation and radiation modification in improving thermal comfort. Landscape and Urban Planning.*
- Theobald, E. (2014, December 8). *Global change and local solutions: Tapping the unrealized potential of citizen science for Biodiversity Research.* Biological Conservation. Retrieved March 29, 2023, from <https://www.sciencedirect.com/science/article/pii/S0006320714004029>
- United Nations. (n.d.). *About small island developing states | office of the high representative for the least developed countries, landlocked developing countries and Small Island Developing States.* United Nations. Retrieved March 26, 2023, from <https://www.un.org/ohrrls/content/about-small-island-developing-states>
- *Utilities Report - Central Bureau of Statistics.* CBS Aruba. (2010). Retrieved March 27, 2023, from https://cbs.aw/wp/wp-content/uploads/2015/10/UtilitiesReport_okt_2010.pdf
- van Leeuwen, H. J. A. (2016). *Harmonoise: Simplification of comprehensive source and ... - DGMR.* DGMR Consultants for construction, industry, traffic, environment and software. Retrieved April 28, 2023, from <https://dgmr.nl/wp-content/uploads/files/Harmonoise%20-%20simplification%20of%20comprehensive%20source%20and%20propagation%20models%20into%20an%20accurate%20and%20practicable%20engineering%20method.pdf>
- Zhu, Z. (2010, April). *The investigation of noise attenuation by plants and the corresponding ...* Research Gate. Retrieved March 30, 2023, from https://www.researchgate.net/publication/43344334_The_Investigation_of_Noise_Attenuation_by_Plants_and_the_Corresponding_Noise-Reducing_Spectrum



Alexandra Ulacio, University of Aruba

“Everything happens for a reason”...

Oh boy, let me tell you about my thoughts on this program! I am currently sitting at school, trying to figure out what to write. But instead of feeling stuck, I am filled with joy and gratitude for something that has changed my perspective on life. It's the simple notion that “everything happens for a reason” and that we should take things as they come.

As a big dreamer and ambitious person, this idea has been a game-changer for me. It's helped me in this program when things didn't go as planned, as well as given me a sense of peace in my everyday life. You see, if I had the power to make everything go according to plan a few years ago, I wouldn't be here right now, writing this reflection. I would have missed out on so many amazing opportunities that have come my way. But luckily, life never goes according to plan and I've come to learn that that's a good thing. Things always end up better than I could have ever imagined.

Writing my paper reminded me of something I already knew about myself, but hadn't felt in a while. It was 10 PM on a Friday, and I was on campus, sitting in the courtyard with only the security guard for the company. I'd been there since 11 am, working on my paper, and even though I was exhausted, I didn't want to stop. I was having so much fun researching and writing about waste management and smart bins. It was at that moment that I was reminded of a time back in high school when I had to write a final report. I chose the topic of time travel through the eyes of Einstein, something I was extremely passionate about. I spent endless hours researching and writing my paper, but I never once felt irritated or annoyed. That's what life is all about - enjoying what you do. So, whether it's a thesis topic, a job, a project, or anything else, choose something you're passionate about, and the journey will be just as rewarding as the destination.

I would describe the UAUCU program as a rollercoaster ride. There are moments when you feel like you're on top of the world - carpooling with 8 people in a small car, visiting new places with new friends (shoutout to Colombia!), snorkeling with turtles, dancing next to energetic teenagers at Moomba, and swimming on the beach at night. And then there are moments where you're exhausted from sitting behind your computer, trying to make sense of your paper, feeling like you're going insane as you try to juggle school and life.

But you know what? I wouldn't have it any other way. I am so grateful for all the beautiful, yet sometimes distressing moments I've experienced during this program. And I couldn't have done it without the support and love of my friends and family, Eric for the kindness he showed us during the program and his patience and flexibility with my super late deadline submissions, my thesis supervisor Alba for her guidance, the UA community who are always kind and caring, my new bestie chatGPT in helping me with my paper, and last but not least, Aruba, my safe heaven I will always call home.

So here's to another edition of the book! Cheers!



Sorting Waste In A Smart Way: Conceptual Design of Small-Scale Smart Bins for The Improvement of Waste Sorting in SIS

Alexandra Ulacio

1. Introduction

Waste management is at a critical state worldwide as the amount of waste generated continues to increase with population growth, urbanization, and consumerism (Karakas, 2021). Small Island States (SIS) also face issues with waste management, yet in more unique ways than other countries. Their limited space for waste disposal, underdeveloped waste infrastructure, limited regulations and poor enforcement, barriers to waste transportation, and limited recycling opportunities due to economies of scale have hindered progress toward sustainable waste management (SWM) (Fuldauer et al., 2019). All these factors make waste management in SIS a complex issue and contribute to there not being one straightforward easy solution. It can therefore be considered a ‘wicked problem’ that requires creative and innovative holistic approaches beyond just analyzing and optimizing technical systems to address effectively (Moraes et al., 2021; Lonngren & Svanström, 2015; Puen, 2023).

Recycling is a crucial waste management practice that plays a significant role in safeguarding natural resources and minimizing solid waste and has been identified as an important waste management measure for SIS (Fuldauer et al., 2019; Karakas, 2021; Mihaliková & Lachytová, 2020). The practice involves separating, collecting, and preparing waste materials to enable their reprocessing or remanufacturing

into alternative materials (Mohee et al., 2015). There is little involvement in recycling activities in SIS due to the relatively smaller population, economic development, and the lack of education and awareness of the community and decision-makers on such matters (Mohee et al., 2015). Regardless, policymakers have regarded recycling as an important waste management measure for SIS (CBA, 2019; Fuldauer et al., 2019; UNEP, 2019).

One important step in the recycling procedure is waste sorting (Mohee et al., 2015). This involves the separation of waste materials which are then placed into designated waste containers for proper sorting (Mihaliková & Lachytová, 2020). This practice has been successfully implemented in various countries, highlighting its recognized significance in reducing waste generation and promoting recycling efforts (Hao et al., 2023). While there is a lack of research on the matter in SIS, waste sorting is valued as an effective approach to waste management in other countries, and implementing this measure in SIS could potentially aid with the waste challenges present.

Waste sorting is most optimal when implemented at the source of waste generation, such as in households, offices, and commercial areas (Mihaliková & Lachytová, 2020). However, traditional sorting measures in these areas can be met with some challenges. Factors such as limited cognizance of waste management practices, convenient recycling measures,

and waste regulations and incentives all contribute to the community not having adequate knowledge or not feeling morally or socially pressured to sort waste adequately and dispose of it in a sustainable manner (Fuldauer et al., 2019; KARAKAŞ, 2021; SER, 2017).

One solution to address such waste sorting challenges can be implementing mechanisms that sort waste automatically, reducing the reliance on individuals to separate waste manually (Pereira et al. 2019). *Smart bins* are technologically advanced waste bins equipped with hardware and software components that help improve waste management. These bins can be equipped with different components that detect the type of waste being disposed of and direct it to the appropriate compartment within the bin, while simultaneously collecting waste data (Fataniya et al., 2019; Pardini et al., 2020; Patel et al., 2020). Smart bins increase the efficiency of waste sorting and thus the number of recyclable materials that are diverted from landfills (Fataniya et al., 2019; Pereira et al., 2019).

Various types of smart bins are already available. These can be categorized based on their scale: either large or small. Large-scale smart bins are commonly installed in communal areas where a significant amount of waste can be disposed of all at once (Burger et al. 2020; Zhang & Zhu, 2020). However, the effectiveness of recycling with these types of bins can still be hindered by the need for human efforts to sort the waste previous to using the bin. On the other hand, implementing small-scale smart bins at the main waste generation points can address waste sorting challenges at the source, reducing the need for human effort in sorting (Mihaliková & Lachytová, 2020; Pereira et al., 2020).

Moreover, Burger et al. (2020) differentiate smaller-scale smart bins into home or indoor smart bins for personal use, and public smart bins to promote environmental awareness. While households are a main source of waste generation, implementing smart bins in homes can be challenging

due to the high initial costs. Therefore, it is more feasible to implement smart bins in public areas. However, while addressing waste sorting challenges in public areas is necessary, it is equally important to extend the impact to individuals' homes. By incorporating an additional educational feedback feature, as suggested by Burger et al. (2020) and supported by Guna et al. (2020), users can learn about SWM measures, potentially empowering them to adopt these measures in their households.

By incorporating various technological systems to tackle different challenges, smart bins hold the promise to serve as a holistic approach that can help tackle the wicked problem of waste management in SIS. Moreover, a crucial factor in establishing an effective waste management system is a comprehensive understanding of the waste produced, the available recycling resources, and the environmental awareness of the society in question. Therefore, this research focuses on the Caribbean island of Aruba, where challenges in adopting SWM practices are present. These challenges arise from limited waste management measures, limited knowledge about SWM, and a fragile regulatory system that lacks sufficient data due to limited research conducted on the topic (GoA, 2019; SER, 2017; WWPA, 2018). Based on this, this research aims to create a conceptual design of a smart bin that focuses on incorporating suitable components for successful implementation in Aruba, to address the existing waste sorting challenges. This design will serve as the blueprint for the further development and implementation of the smart bin. This design will serve as the blueprint for the further development and implementation of the smart bin.

This research is part of a bachelor's thesis project, and this paper aims to outline the initial steps and preliminary design of the final product. To achieve the research objective, a Design Thinking methodology was followed. This method is characterized by a non-linear, iterative, and user-centered approach and encompasses five stages of design: *Empathize*,

Define, Ideate, Prototype, and Test. Each stage has a different aim and utilizes different methods to acquire data. In this paper, the results of the methods used in the Empathize, Define, and Ideate stages will be presented.

The remaining parts of this paper are designed as follows: Chapter 2 explores the research methodology. Chapter 3 presents the research findings, and finally, Chapter 4 presents conclusions and areas for further research.

2. Research Methodology

The methodology used for this research is Design Thinking (DT). DT is a problem-solving methodology characterized by its non-linear, iterative, and user-centered nature (Cieminski, 2022; Plattner, 2010; IDF, n.d.). It has been employed by businesses to design products and services, and by non-profit organizations to enhance their services for marginalized and vulnerable individuals and communities (Puen, 2023). DT offers a solution-based approach, particularly valuable for addressing complex and undefined problems - *wicked problems* (IDF, n.d.; Puen, 2023). By focusing on understanding human needs, reframing the problem from a human-centric perspective, and generating multiple ideas through various methods, design thinking proves to be highly useful in designing user solutions (IDF, n.d.). Since, to the author's knowledge, there have been no previous studies conducted on waste sorting smart bins in SIS or Aruba, adopting DT as the methodology for this research becomes essential for the alignment of the smart bin design with the unique requirements and needs of the Aruban context. There are multiple models of DT (Cieminski, 2022), but for this research, the model developed by the Institute of Design at Stanford, a DT institute at the renowned Stanford University, will be utilized (Plattner, 2010). This approach encompasses five key stages in the DT process: *Empathize, Define, Ideate, Prototype, and Test.* Each stage has a distinct aim and employs different methods to gather the required data. Moreover, the iterative nature of

DT enables feedback and insights gained from each stage to inform and further shape the different stages (IDF, n.d.). Therefore, the DT process requires flexibility, openness to new ideas, and a willingness to adapt the approach based on emerging findings and insights. *Figure 1* provides a visual representation of the five stages of DT and how iterations can happen within these stages.

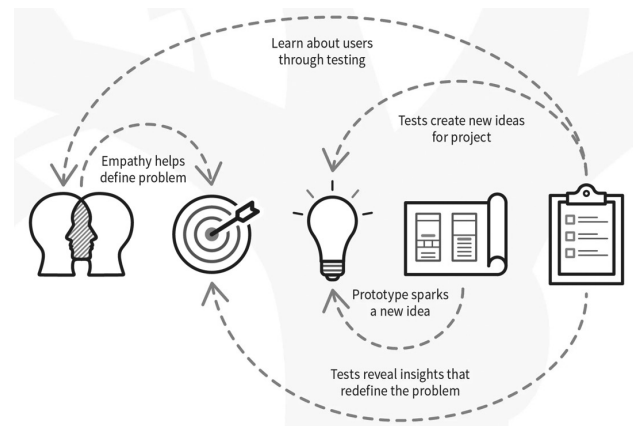

Figure 1. Image showing the DT stages and iteration process. Stages from left to right: *empathize, define, ideate, prototype, and test* (IDF, n.d.).

As the scope of this paper was limited to the initial steps and preliminary findings of the research project, the only stages that were employed were the first three stages of DT: *Empathize, Define, and Ideate.* The *prototype* and *test* stages were left for future research to obtain the final research results. Iterations can happen within any stage of the DT process. However, as this paper only employs the first three stages of DT, there was limited iteration between the stages of this research. The following paragraphs provide an overview of the three stages and detail the methods used to gather data at each stage. *Table 1* presents the stages and the methods employed in each stage.

Stage	Methods used
1. Empathize	1. User observations 2. Waste bin items observations
2. Define	1. Analysis of data acquired in Empathize stage 2. Desk research on waste management in Aruba 3. 'How-Might-We...?' statements
3. Ideate	1. Brainstorming sessions 2. Desk research on existing waste sorting smart bins 3. 3D CAD prototyping

Table 1. *Stages and methods used for this paper.*

2.1. Empathize

The DT process starts with the first stage of *Empathize*. This stage is an integral part of the human-centered design process, focusing on understanding people within the context of a design challenge. It involves observing, engaging, and listening to users to gain empathy for their needs, behaviors, and values. The goal is to develop empathy and see things from a fresh perspective, which ultimately leads to innovative solutions. This stage emphasizes the importance of recognizing hidden beliefs and values that shape user experiences and using the environment as a prompt for deeper understanding. In *Empathize*, observation can be used as a method.

The aim of this research is to develop a conceptual design of a smart bin that tackles the waste sorting challenge present in Aruba. Therefore, to understand what issues users face when confronted with waste sorting practices, the first method in this research was observations to study the usage of normal and recycling waste bins at the University of Aruba. The research user group for this method included students, lecturers, employees, and visitors of the university. Specifically, observations were carried out for one hour each day over the course of a week, focusing on a pair of

bins from each category that are placed next to each other. Users' behavior when approaching the bins and disposing of waste items was observed. Furthermore, throughout the same week, observations were conducted on all waste bins present on the campus, both regular and recyclable bins. This was done to analyze the types of items users disposed of in these bins and evaluate how effectively this is done. Additionally, the *Empathize* stage includes conducting interactive short interviews with users to gain a deeper understanding of their concerns and personal experiences related to the problem being studied. However, due to time constraints, this method was not performed in this research.

2.2. Define

Subsequently, the *Define* stage was continued. This stage involves bringing clarity to the design process by crafting relevant problem statements (PS) based on user insights and needs. It helps define the right challenges to address and leads to greater quantity and higher quality solutions when you are generating ideas.

The *Define* stage typically utilizes the method of analyzing and synthesizing information through identifying patterns and developing PS to frame the problem. In addition to this method, desk research was performed to explore waste management practices, regulations, and user involvement documentation in Aruba to help formulate further PS. Although these documents may not directly address waste sorting challenges, their findings remain relevant as waste sorting is a part of the broader waste management system. If the overall waste management system is not handled properly, it can have an indirect impact on the effectiveness of waste sorting. Furthermore, while not a traditional method of the d.school (Plattner, 2010) design process, this research was deemed valuable in complementing the analysis of data gathered during the *Empathize* stage. As a last step before moving to the next stage, it is suggested to make a list of statements using the 'How-Might-We...?' (HMW) method that helps make the transition from

the problem identification stage (*Define*) to the solution generation stage (*Ideate*).

2.3. Ideate

Finally, the *Ideate* stage was employed. This stage focuses on idea generation by exploring solutions for the HMW statements formulated in the *Define* stage. *Ideate* involves combining understanding with imagination to generate diverse solution concepts, encourage innovation, and uncover unexpected areas of exploration. Methods such as brainstorming sessions and sketch prototyping help generate and visualize various ideas.

In this research, 30 to 60-minute brainstorming sessions with academics and industry experts were held where smart bin components and features were proposed using the HMW statements formulated in the *Define* stage. Four sessions were conducted with participants who have backgrounds in waste management systems and/or engineering technologies. Furthermore, the session followed an iterative process where the ideas generated in one session were presented in the subsequent session to encourage further discussion and the introduction of additional ideas beyond the ones already mentioned. This approach was taken to help prompt outside-the-box solutions, as the more obvious and straightforward ideas had already been mentioned. Alongside the brainstorming sessions, desk research was carried out to explore previous studies on waste sorting smart bins and identify existing possible solutions. The analysis was guided by the HMW statements to identify relevant solutions. The selected year range for the analyzed papers was between 2017-2023, ensuring the inclusion of up-to-date and relevant information. The literature was obtained by conducting keyword searches related to the smart bins on online databases such as EBSCO, JSTOR, and Google Scholar. This method, although not traditionally part of the d.school (2010) design thinking process, was employed to further support and expand upon the ideas generated during the brainstorming sessions. Finally, from

these proposed solutions, a 3D CAD was made as a virtual prototype to visualize the ideas.

3. Research Results and Discussion

This chapter presents the results of the methods used during the research. The chapter is divided into three subchapters based on the three stages of the DT methodology that were employed for this paper. For each stage, a table with the defined methods and results is presented at the end of the subchapter.

3.1. Empathize

The purpose of this DT stage is to thoroughly understand the user's concerns and needs regarding waste sorting. This is accomplished through observational methods, where the user's interaction with waste bins is observed, along with an analysis of the waste items present in the bins. The following paragraphs present the results of this stage..

3.1.1. Method 1 - User observations

The first method employed in the *Empathize* stage was that of observing users disposing of waste items in waste bins. From the observations, two distinct behavioral patterns were observed:

1. Improper waste disposal disregarding the type of waste and waste bin
2. Proper waste disposal by checking the type of waste and waste bin before disposal

While both behaviors were observed, most users exhibited the improper waste disposal behavioral pattern.

3.1.2. Method 2 - Waste bin items analysis

Subsequently, observations were carried out on all waste bins situated within the University of Aruba campus, both regular and recyclable bins, to assess the waste sorting patterns of the users. The observations revealed that

the recycling bins contained more recyclable items than the regular bins, however, a mix of recyclable and non-recyclable items was present in both types of bins.

Method	Results
1. User observation	<ul style="list-style-type: none"> - Two behavioral patterns of users were identified: improper and proper waste disposal - Most users displayed improper waste disposal behavior
2. Waste bin observation	<ul style="list-style-type: none"> - Recycling bins contain more recyclable materials than regular bins - Both types of bins contained a mix of recyclable and non-recyclable waste.

Table 2. Results of the methods employed in the Empathize stage.

3.2. Define

The purpose of this stage is to analyze the problems identified in the *Empathize* stage and synthesize PS that can be utilized to understand what technological components a smart bin needs to help solve the problem. This was done through the use of data analysis and desk research on the waste management system of Aruba. An additional method of HMW statements was performed to aid the transition from problem identification to solution generation. The following paragraphs present the finding of the research performed in this DT stage.

3.2.1. Method 1 - Analysis and synthesis from Empathize data

The first method employed to find these PS is analyzing the results of the Empathize stage to synthesize PS. The results imply that users do not have regard for proper waste disposal as they show wrong waste disposal behaviors.

This was supported through the waste items observations of all the waste bins, as the items were not sorted properly. Disregard for SWM practices can be attributed to various factors such as a lack of interest and awareness of solid waste management practices, limited societal and regulatory pressure, and inconvenient accessibility of recycling bins (Karakas, 2021; Mihaliková & Lachytová, 2020). Based on this, the PS for this method is that *improper waste sorting is present due to the user's disregard for utilizing sustainable measures when disposing of waste.*

3.2.2. Method 2 - Desk research on the waste management landscape in Aruba

The second approach employed in this stage involved conducting a desk research analysis of existing waste management documentation in Aruba. The purpose of this analysis was to identify challenges in the waste management system that can potentially impact waste sorting. The findings from this analysis are presented in the following paragraphs, and corresponding PS were formulated at the end.

The Caribbean island of Aruba is no exception to the wicked problem of waste management, as it faces several challenges in the matter. Aruba has a population of approximately 110,000 citizens, which is predicted to keep increasing over time (CBA, 2021; CBS, 2022). The island received in 2019 almost two million visitors, more than double the population on an average monthly basis (CBS, 2021). As a result, the amount of waste the island generates is significantly higher than it can sustain (CBA, 2019; WWPA, 2018). Additionally, the increase in population size also puts additional pressure on the waste management of the island (CBA, 2021). For years, the majority of the waste produced was sent to the island's landfill Parkietenbos. However, on the 31st of December 2022, the landfill was closed as it reached its maximum capacity. There was also major pressure on the government by the community to close the landfill as it was causing serious negative effects on the surrounding environment and the community's physical and mental well-being (Mijts et

al., 2022). Additionally, this measure was also introduced to promote sustainable waste disposal measures (Trash2Cash, n.d.). Currently, domestic and commercial waste is collected by Serlimar and Ecotech, the waste collection companies on the island, and sent to the Ecotech Freezone installation, which accumulates all types of waste and stores it in bales deposited in holes in the ground (Aruba Gobierno, n.d.; KIVI, n.d.; WWPA, 2018). Furthermore, Ecotech separates recyclable materials from the waste they receive at their facility (Henriquez, 2022). Considering the large amount of waste handled, it is possible that a significant portion of recyclable materials may face difficulties in the separation process, which could result in them being mistakenly thrown away as non-recyclable waste. Additionally, while technically feasible, waste sorting after collection is not advised, as it may result in lower purity and quality of the sorted components compared to when it is sorted at the source (Mihaliková & Lachytová, 2020).

The government of Aruba (GoA) has shown concern by implementing several initiatives and regulations to try to manage waste efficiently and sustainably. Some examples are waste regulations such as the plastic-ban law, AB 1995 no. GT 8 Article 55a, introduced in 2017 to prohibit the distribution of plastic bags and subsequently expanded in 2019 in AB2019 no.67 to include various single-use plastic items. Furthermore, the GoA promotes the recycling of waste by identifying several waste streams and providing a blueprint indicating where the waste materials of each stream can be disposed of, highlighting companies that recycle or reuse the materials as being the most preferred companies for waste disposal (Trash2Cash, n.d.).

Despite the government's ambition to transition to a SWM system, the number of initiatives implemented only cover a small fraction of the overall waste management system, making it challenging to bring about significant change. Furthermore, there is also a lack of implementation of additional proposed initiatives, as well as limited regulations

and regulatory enforcement and instruments to support the already implemented initiatives (CBA, 2019; SER, 2017; WWPA, 2018). This shortcoming can diminish the sense of importance and urgency among the Aruban population to engage in recycling practices. A study mentions that a lack of implemented infrastructures for recycling has a negative influence on the effectiveness of recycling in households (Karakaş, 2021). Additionally, the study also mentions that correct perception of political regulation leads to environmentally responsible behavior. Similarly, Mihaliková & Lachytová (2020) note that attention must be paid to raising environmental awareness of the population as this will increase public participation in governance. As a result, waste management processes, such as waste sorting, can be ineffectively performed, leading to a significant reduction in the amount of recyclable waste that effectively reaches the recycling facilities. For example, 27.3% of Aruba's total waste generation consists of plastic. Of this amount, less than 1% is recycled (Trash2Cash, n.d.).

Aside from governmental initiatives, the community has also implemented efforts to help mitigate the waste issue. For example, recycling bins have been implemented at the University of Aruba by the environmental student organization MAGEC. The purpose of these bins is to facilitate the recycling of aluminum and plastic on campus. To distinguish them from regular waste bins, they are painted green. In addition, posters are placed on the bins to guide the types of materials that can be disposed of in the bins. From personal experience as a MAGEC member, and the observations performed during the *Empathize* stage, it is evident that the usage of these recycling bins is not optimal. These first hand observations suggest a limited awareness and regard for proper waste management by the community, as supported by GoA (2019) and SER (2017).

Despite the efforts to implement initiatives on the island, several challenges still impede the progress toward SWM developments in Aruba. These challenges include limited

and/or improper participation in SWM due to: 1. limited waste management measures; 2. a fragile national waste management regulatory system; and 3. limited public awareness of SWM practices. Based on these challenges, the following PS were defined:

- *Limited SWM participation due to a limited number of waste management measures available*
- *Improper and limited SWM participation due to the user's limited awareness of SWM*
- *Improper and limited SWM participation due to a fragile national waste management regulatory system*

Method	Results (PS)
1. Analyze results from Empathize stage	1. Improper waste sorting due to user disregard of SWM measures when disposing of waste
2. Desk research on Aruban waste management	2. Limited SWM participation due to lack of waste management measures available 3. Improper and limited SWM participation due to the user's limited awareness of SWM 4. Improper and limited SWM participation due to a fragile national waste management regulatory system

Table 3. Results of the methods employed in the Define stage.

3.2.3. Method 3 - 'How-Might-We...?' statements

Lastly, HMW statements were created based on the PS identified during the first and second methods of this stage (Table 4). The statements were formulated to prompt solution ideas for smart bin design requirements that

effectively tackle the identified challenges. However, a HWM statement was not made for the second PS as the objective of this research is already a solution to address the challenge of limited SWM measures present in Aruba.

PS	HMW statements
1.	"How might we design a smart bin for users so that proper waste sorting is performed despite the user's regard for SWM practices?"
2.	"How might we design a smart bin for users so that users' awareness of SWM can be increased?"
3.	"How might we design a smart bin for users so that the national waste management regulatory system can be strengthened?"

Table 4. HMW statements for the formulated PS during the Define stage.

3.3. Ideate

The purpose of this stage is to generate solutions for the challenges identified during the Define stage. Brainstorming sessions with academics and industry experts on waste management and/or engineering technologies were conducted. The sessions were guided using the HMW statement formulated in the Define stage. Furthermore, a desk research analysis was conducted on existing waste sorting smart bins to further find solutions to the identified challenges. Using the solutions derived from the brainstorming sessions and desk research, visual representations of the proposed solutions were created in the form of 3D CAD designs.

3.3.1. Method 1 - Brainstorming sessions

Utilizing the HMW statements as guiding questions, four brainstorming sessions were conducted with academics and industry experts to come up with solutions to the generated PS in the Define stage. During the sessions, several solutions related to hardware and software

components and features for the smart bin were proposed. Furthermore, as the sessions progressed iteratively, some participants did not contribute any new solution ideas beyond those presented in the previous session. This absence of additional ideas is presented in the table as “no additional ideas”. Table 5 displays the suggested solutions proposed for each HMW statement.

Session	HMW 1 - waste sorting	HMW 2 - user awareness	HMW 3 - strengthen regulatory system
1. With academic specialized in waste management	<ul style="list-style-type: none"> - Camera to identify incoming waste items and categorize them - Conveyer belt to move items around in the bin - Separate box in the bin where incoming items can be identified and then sorted 	<ul style="list-style-type: none"> - Two exterior holes corresponding to recyclable and non-recyclable waste - A screen on the exterior for user interaction 	<ul style="list-style-type: none"> - Weight sensors to collect waste data
2. With academic specialized in engineering and education	<ul style="list-style-type: none"> - Collapsible flaps on the exterior holes of the bin - Motion sensor to identify when a waste item enters the bin 	<ul style="list-style-type: none"> - Red and green light on the exterior of the bin for user feedback of bin usage 	no additional ideas
3. With an industry expert on SWM in Aruba	<ul style="list-style-type: none"> - An open-source online platform to label images for image classification - A spectrometer to identify different types of plastic 	no additional ideas	<ul style="list-style-type: none"> - Connecting a waste app to the smart bin for data monitoring
4. With academic specialized in software engineering	<ul style="list-style-type: none"> - A microcontroller suitable for the smart bin functions - Already existing image classification models such as Convolutional Neural Networks - An offline image classification algorithm stored on a device located in the bin 	no additional ideas	no additional ideas

Table 5. Proposed ideas of technological components for the smart bin during the brainstorming session.

3.3.2. Method 2 - Desk research on existing waste sorting smart bin

This section of the report presents desk research of existing literature on smart bin designs and their components. Additionally, the HWM statements were used to guide the analysis. Some studies prioritize the hardware components, while others place a greater emphasis on the software aspect of the mechanism. Therefore, the analysis is divided into two subsections, one for hardware-focused studies and one for software-focused studies. At the end of each section, a table is included to provide a summary of the solutions identified during the analysis.

Hardware-Focused Literature

Smart bins typically employ a two-step process to sort waste: first, by identifying the type of waste, and then by sorting it into the appropriate compartment. Some smart bins rely solely on sensors for waste identification (Fataniya et al., 2019; Kumar et al., 2017), while others incorporate an additional camera module to assist in the identification process (Longo et al., 2021; Patel et al., 2020; Shenoy et al., 2022). Sensors analyze specific characteristics of the incoming waste to determine its appropriate waste type. On the other hand, the camera is strategically positioned to capture an image of the waste item after entering the bin. This image is then processed through an artificial intelligence (AI) algorithm that classifies the item into a specific waste type. While relying solely on sensors allows for the identification of various waste types (Kumar et al., 2017), it often necessitates adding various types of sensors for each type, which can result in increased costs. This may explain why some designs limit the number of categories to a select few (Fataniya et al., 2019; Patel et al., 2020; Pereira et al., 2019). On the other hand, utilizing a camera module offers the advantage of identifying a broader range of categories, as the AI algorithm can be expanded to accommodate additional categories as needed (Longo et

al., 2021; Vu & Kaddoum, 2017). However, it should be noted that the use of a camera module restricts the bin's ability to identify and sort only one waste item at a time (Longo et al., 2021; Patel et al., 2020).

To sort items into respective compartments, some smart bin designs utilize a motor-controlled flap that moves in one physical dimension (Fatanyia et al., 2019; Patel et al., 2020). This method, however, limits the number of waste types that can be sorted, due to its limited movement. Alternatively, other designs employ more advanced methods such as robotic arms (Cheema et al., 2022; Shenoy et al., 2022), conveyor belts (Gupta et al., 2018), and rotating circular structures (Agbehadji et al., 2022; Longo et al., 2021) to sort a wider range of categories. While more mechanically complex, these methods offer greater flexibility in sorting as they allow for strategic and ample movements.

Certain studies introduce components aimed at raising awareness of SWM. Burger et al. (2020) and Guna et al. (2022) suggest incorporating a screen to provide users with feedback on their proper or improper use of the bin. This mechanism aims to raise cognizance of SWM by giving feedback to users on how they use the bin.

Some studies incorporate other types of sensors to give the bin additional features. For example, some designs include sensors to measure the weight of the incoming waste (Guna et al., 2022; Longo et al., 2021; Pardini et al., 2020), while other designs have sensors to measure the fill level of the bin (Fatanyia et al., 2019; Gupta et al., 2018; Shenoy et al., 2022; Verma et al., 2020). These sensors add additional data collection and monitoring features that allow for the optimization and improvement of the system (Mishra et al., 2022; Sidhu et al., 2021).

HMW 1	HMW 2	HMW 3
Waste identification system using: - a camera - sensors - both a camera and sensors	A screen allowing for user interaction	Weight sensors for used data collection
Waste sorting system using - motor controlled flaps: - a robotic arm - conveyor belts - circular rotating structures		Fill level sensors used for monitoring and data collection

Software-Focused Literature

The papers that employ a camera as a waste identification method utilize an AI image classification algorithm. After researching and comparing algorithms with each other, most studies concluded that the best performing algorithm is a type of machine learning (ML) model called convolutional neural network (CNN) (Agbehadji et al., 2022; Azis et al., 2020; Fadlil et al., 2022; Bobulski & Kubanek, 2019; Hulyalkar et al., 2018; Shi et al., 2021; Sreelakshmi et al., 2019; Vu & Kaddoum, 2017). It involves extracting features from an image dataset, clustering the data, and then using this information to classify unknown images accurately. A CNN consists of multiple layers, including the Convolutional layer, activation and pooling layers, and the fully-connected layer, as illustrated in *Figure 2* (Fadlil et al., 2019).

Table 6. Summary of hardware components used in previous smart bin research.

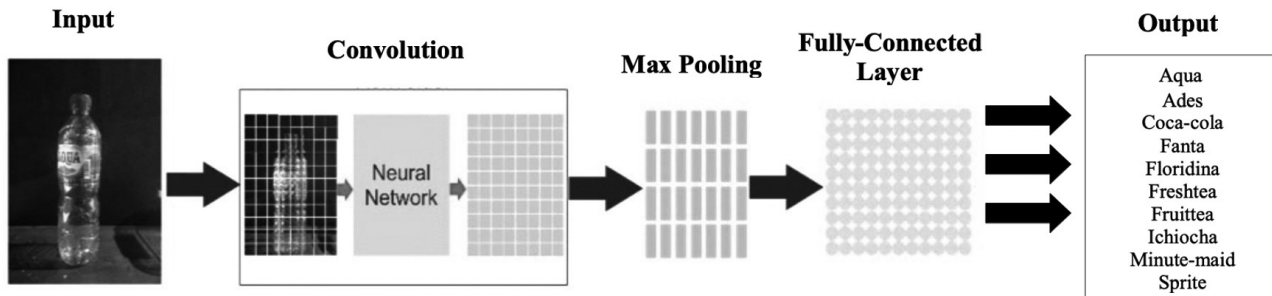

Figure 2. Steps in the CNN model (Fadlil et al., 2019).

CNN is a technique widely and has been proven to be very effective in learning from existing data leading to more efficient identification and classification of waste objects (Azis et al., 2020; Hulyalkar et al., 2018; Nnamoko et al., 2022). In addition, some studies focused on the performance of existing CNN models, with certain image input and algorithm parameters influencing the algorithm's accuracy (Agbehadji et al., 2022; Cheema et al., 2022; Mao et al., 2021; Shi et al., 2021; Sreelakshmi et al., 2019). Most models showed an accuracy of 85-95% when predicting waste images.

Certain designs incorporate a mobile application (app) that enables users to monitor the usage of the smart bin. This functionality includes features such as tracking the quantity and types of waste sorted by the bin. Some mobile applications are designed for monitoring and optimizing bin usage (Akshayaa et al., 2021; Maulana et al., 2018), assisting local governments in forming proper waste management systems (Aguila et al., 2019), while others aim to encourage user interaction and proper waste disposal (Gupta et al., 2018; Pardini et al., 2020).

Additionally, some studies mention the system incorporated for storing, processing, and analyzing data from sensors. Typically, this is achieved through either a cloud-based server that utilizes WIFI connectivity to connect to the Internet of Things (IoT) technology of the smart bin (Fatanyia et al., 2019; Kumar et al., 2017; Pereira et al., 2019). This is particularly crucial for smart bins that employ image classification to sort waste, as the captured waste image is processed by an algorithm stored in a server (Shamin et al., 2019). On the other hand, some studies opted to use a cellular network instead, as it offers benefits such as faster waste recognition and reduced energy consumption, enhancing the practicality of the smart bin for everyday use (Longo et al. 2021, Shenoy et al., 2022). As microcontrollers work as an intermediary between the sensors and the data storage systems, Shamin et al. (2019) mention that the chosen microcontroller needs to contain the necessary

connectivity capabilities, such as WiFi, Bluetooth, or GSM needed for the chosen data storage system.

HMW 1	HMW 2	HMW 3
Image classification algorithm - CNN model	App used for user interaction with smart bin	App used to assist local governments in forming waste management system
Cloud-based server for data processing and analysis connected via: - IoT - GSM network		Cloud-based server for data storing and analysis connected via: - IoT - GSM network

Table 7. Summary of software components used in previous smart bin research.

3.3.3. Method 3 - 3D CAD designs of solutions

Based on the proposed solutions and findings from the previous methods in this stage, three smart bin systems were identified as potential solutions:

1. A self-sorting system composed of technical components to address the improper waste sorting of disposed items
2. A data collection system composed of technical components that collect and store smart bin waste data to help strengthen the waste management regulatory system
3. A user interaction system composed of technical components to address the limited knowledge of users on SWM practices

By integrating these systems with the specific technical components identified in the previous methods of this stage, it is possible to create 3D CAD designs that provide a visual representation of the ideas and highlight any potential

limitations of certain proposed solutions. However, due to time limitations, only one 3D CAD design was created, incorporating some of the proposed components related to the three identified systems (*Figure 3*). This design is just one example, but there are multiple possibilities for combining different components together.

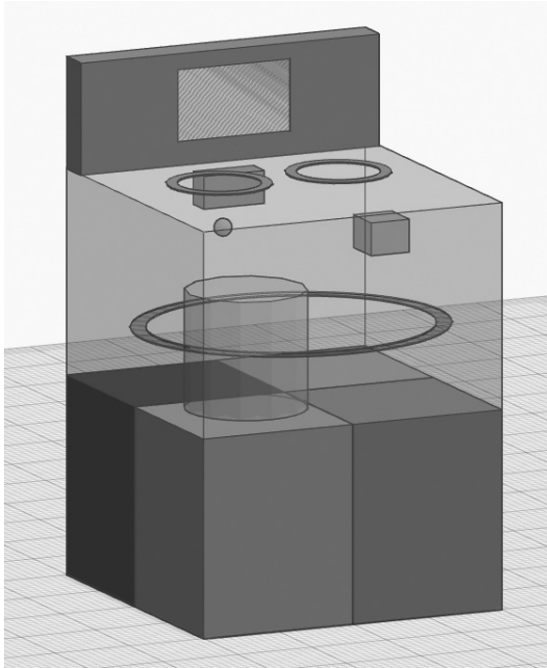

Figure 3. 3D CAD design of the smart bin.

First, the design consists of an automated waste sorting system. The interior of the bin includes an identification box (gray cylinder) that is aligned with the exterior holes and is equipped with a camera (blue sphere) that captures an image for the AI algorithm to classify the item. The ID box is further connected to a waste sorting system (gray circle) that facilitates proper waste sorting within the bin. Additionally, there are three individual bins (colored rectangles) within the smart bin, designated for the plastic,

metal, and non-recyclable waste categories. These categories were chosen based on the materials that are currently being recycled in Aruba (Trash2Cash, n.d.).

Furthermore, the design consists of a user interaction system. The exterior of the bin includes two distinct holes, one for recyclable, and one for non-recyclable waste disposal. Additionally, a user interface (UI) screen (gray rectangle) is also included in the exterior.

Lastly, the data collection system was included by adding a microcontroller (red rectangle) that is equipped with IoT capabilities to store and process the data acquired from the technologies in the bin. These technologies include motion sensors, weight sensors, and the camera. The microcontroller has WIFI connectivity capabilities that allow for data to be interchanged between the smart bin and an online cloud server.

4. Conclusions & What Comes Next

Waste management is a wicked problem faced by countries worldwide, including small island states like Aruba. These island nations encounter unique challenges in waste management due to their distinct characteristics. To address these challenges, innovative solutions are necessary, and promising solutions are technologically advanced automated systems, such as smart bins. However, before introducing smart bins into a society, it is crucial to understand the specific waste management challenges faced by the users in that particular environment.

This research aimed to design a smart bin that incorporates technological components to address the specific waste management challenges present in Aruba. Employing a design thinking methodology, user-centered methods were utilized to identify these challenges. The initial stages of the methodology, including *Empathize*, *Define*, and *Ideate*, were employed, utilizing techniques such as observations,

desk research, brainstorming sessions, and 3D CAD design development.

Through the observations conducted during the *Empathize* phase and the desk research conducted during the *Define* phase, several waste management challenges that affect the users in Aruba were identified. These challenges included users' lack of regard for sustainable waste management (SWM) practices, limited SWM measures and awareness, as well as a fragile waste management regulatory system.

To address these challenges, problem statements were formulated, which further led to the creation of "How-Might-We...?" statements. These HMW statements served as guiding questions, prompting technical solutions on how smart bins can effectively mitigate the identified challenges. Brainstorming sessions conducted in the *Ideate* phase generated proposed smart bin technological components, aligning with the HMW statements. Moreover, desk research was conducted on existing waste sorting smart bins to support and add on to the solutions proposed in the brainstorming sessions. This approach facilitated the identification of additional potential solutions. Based on the findings from these methods, three smart bin systems to tackle the waste management challenges were identified: a self-sorting system, a user interaction system, and a data collection system. In line with these systems and the proposed components from earlier stages, a 3D CAD prototype was created to visualize the systems and some corresponding proposed components.

4.1. Further Research

As mentioned earlier, this paper only presented a portion of the complete DT methodology used in this research. The next steps involve developing additional 3D CAD prototypes that incorporate different variations of the proposed components. Subsequently, the *Prototype* and *Test* stages of the methodology will be implemented. These stages will involve testing the various designs with users to assess

their suitability in meeting user needs, as well as identifying any new concerns or challenges that may arise. If necessary, an iterative process will be followed to adapt or add new PS and find new solutions until a design is developed that effectively addresses the needs and requirements of users and can effectively help in mitigating waste management issues in Aruba.

References

- Agbehadji, I. E., Abayomi, A., Bui, K. H. N., Millham, R. C., & Freeman, E. (2022). Nature-Inspired Search Method and Custom Waste Object Detection and Classification Model for Smart Waste Bin. *Sensors*, 22(16), 6176. DOI:10.3390/s22166176
- Aguila, J.M., Dimayuga, H., Pineda, K.O., & Magwili, G.V. (2019). Development of Smart Waste Bin with Integrated Volume and Weight Sensor. *2019 IEEE 11th International Conference on Humanoid, Nanotechnology, Information Technology, Communication and Control, Environment, and Management (HNICEM)*, 1-5. DOI: 10.1109/HNICEM48295.2019.9072885
- Akshayaa, S., Evangeline, R., Sree, S. H., & Banuselvasaraswathy, B. (2021, March). Smart bin for Clean Cities using IOT. In *2021 7th International Conference on Advanced Computing and Communication Systems (ICACCS)* (Vol. 1, pp. 1280-1283). IEEE. DOI: 10.1109/ICACCS51430.2021.9441681
- Aruba Gobierno (n.d.). ARUBA WASTE REMOVAL SERVICES (SERLIMAR). https://www.government.aw/governance-administration/aruba-waste-removal-services-serlimar_45923/
- Azis, F. A., Suhaimi, H., & Abas, E. (2020, August). Waste classification using convolutional neural network. In *Proceedings of the 2020 2nd international conference on information technology and computer communications* (pp. 9-13). <https://doi.org/10.1145/3417473.3417474>
- Bobulski, J., & Kubanek, M. (2019). Waste classification system using image processing and convolutional neural networks. In *Advances in Computational Intelligence: 15th International Work-Conference on Artificial Neural Networks, IWANN 2019, Gran Canaria, Spain, June 12-14, 2019*, Proceedings, Part II 15 (pp. 350-361). Springer International Publishing. https://doi.org/10.1007/978-3-030-20518-8_30
- Burger, G., Uhan, M., Pogačnik, M., & Guna, J. (2020). Snovanje interaktivnega pametnega zabojnika za smeti. *Elektrotehniški Vestnik*, 87(4), 209-216. DOI: URN:NBN:SI:DOC-J6EO3XAS
- Central Bureau of Statistics (CBS) (2022, November 24). The development of the population of Aruba. https://cbs.aw/wp/index.php/2022/11/24/test-births/?utm_source=rss&utm_medium=rss&utm_campaign=test-births#:~:text=By%20the%20end%20of%02022,2020%20Population%20and%20Housing%20Census.
- Central Bureau of Statistics (CBS) (2021, December 15). Tourism in Aruba 2009-2021. *Table 1.3 Total number of visitors, 2009-2021*. <https://cbs.aw/wp/index.php/2021/12/15/tourism-in-aruba-2018/>
- Centrale Bank van Aruba (CBA) (2019). Fostering Economic Resilience: From Roots to Routes. <https://www.cbaruba.org/document/papers>
- Centrale Bank van Aruba (CBA) (2021, December). Governing from the Future – Leading with Impact Prospects, policies, and pathways for Aruba 2040. <https://www.cbaruba.org/readBlob.do?id=10732>
- Cheema, S. M., Hannan, A., & Pires, I. M. (2022). Smart Waste Management and Classification Systems Using Cutting Edge Approach. *Sustainability*, 14(16), 10226. <https://doi.org/10.3390/su141610226>
- Cieminski, A. (2022). Design Thinking: Developing Innovative Solutions to Make a Difference. *Delta Kappa Gamma Bulletin*, 89(1). <https://publication.dkg.org/Journal/89-1/files/basic-html/page8.html>
- Fadlil, A., Umar, R., & Nugroho, A. S. (2022). Comparison of machine learning approach for waste bottle classification. *Emerging Science Journal*, 6(5), 1075-1085. DOI: 10.28991/ESJ-2022-06-05-011
- Fataniya, B., Sood, A., Poddar, D., & Shah, D. (2019). Implementation of IoT based waste segregation and collection system. *International Journal of Electronics and Telecommunications*, 65. DOI: 10.24425/ijet.2019.129816
- Fuldauer, L. I., Ives, M. C., Adshead, D., Thacker, S., & Hall, J. W. (2019). Participatory planning of the

- future of waste management in small island developing states to deliver on the Sustainable Development Goals. *Journal of Cleaner Production*. doi:10.1016/j.jclepro.2019.02.269
- Government of Aruba (GoA) (2019, June 18th). Circular Economy Vision 2050. https://www.government.aw/news/reports-and-documents_47051/item/circular-economy-vision-2050_43238.html
 - Guna, J., Horvat, K. P., & Podjed, D. (2022). People-Centred Development of a Smart Waste Bin. *Sensors*, 22(3), 1288. <https://doi.org/10.3390/s22031288>
 - Gupta, N., Deepthi, V., Kunnath, M., Rejeth, P.S., Badsha, T., & Nikhil, B.C. (2018). Automatic Waste Segregation. *2018 Second International Conference on Intelligent Computing and Control Systems (ICICCS)*, 1688-1692. DOI:10.1109/ICCONS.2018.8663148
 - Hao, M., Xu, S., Zhang, J., & Meng, X. (2023). The Supervision Mechanism of Residents' Waste Separation Behavior: Analysis Using a Tripartite Evolutionary Game Model. *Journal of Environmental and Public Health*, 2023. DOI: 10.1155/2023/2551973
 - Henriquez, L. Ing. (2022, June 2). Ecotech FZ. [Powerpoint Slides]. Echotech Freezone Aruba. <https://www.kivi.nl/uploads/media/629f4ace0f6d5/ecotech-freezone-20220601-kivi.pdf>
 - Hulyalkar, S., Deshpande, R., Makode, K., & Kajale, S. (2018). Implementation of smartbin using convolutional neural networks. *International Research Journal of Engineering and Technology (IRJET)*, 5(4). <https://www.irjet.net/archives/V5/i4/IRJET-V5I4756.pdf>
 - Interaction Design Foundation (IDF) (n.d.). What is design thinking? <https://www.interaction-design.org/literature/topics/design-thinking>
 - Karakaş, G. (2021). Factors affecting women's waste separation behaviour in Turkey. *Centre for European Studies (CES) Working Papers*, 13(2), 181-196. https://ceswp.uaic.ro/articles/CESWP2021_XIII2_KAR.pdf
 - KIVI (n.d.). AFVAL-VERWERKINGSBEDRIJF ECOTECH FREE ZONE TE BALASHI ARUBA. <https://www.kivi.nl/afdelingen/kring-caribbean/activiteiten/activiteit/afval-verwerkingsbedrijf-ecotech-free-zone-te-balashi-aruba>
 - Kumar, B. S., Varalakshmi, N., Lokeshwari, S. S., Rohit, K., & Sahana, D. N. (2017, December). Eco-friendly IOT based waste segregation and management. In *2017 International Conference on Electrical, Electronics, Communication, Computer, and Optimization Techniques (ICEECCOT)* (pp. 297-299). IEEE. DOI: 10.1109/ICEECCOT.2017.8284686
 - Longo, E., Sahin, F. A., Redondi, A. E. C., Bolzan, P., Bianchini, M., & Maffei, S. (2021). A 5G-Enabled Smart Waste Management System for University Campus. *Sensors*, 21(24), 8278. <https://doi.org/10.3390/s21248278>
 - Lonngren, J., & Svanström, M. (2015). Assessing "Wicked Sustainability Problem"-Literacy in Engineering Education. *Proceedings of the ASEE Annual Conference & Exposition*, 1-13. https://www.researchgate.net/publication/283131824_Assessing_Wicked_sustainability_problem-literacy_in_engineering_education
 - Mao, W. L., Chen, W. C., Wang, C. T., & Lin, Y. H. (2021). Recycling waste classification using optimized convolutional neural network. *Resources, Conservation and Recycling*, 164, 105132. <https://doi.org/10.1016/j.resconrec.2020.105132>
 - Maulana, F.R., S. Widyanto, T.A., Pratama, Y.D., & Mutijarsa, K. (2018). Design and Development of Smart Trash Bin Prototype for Municipal Solid Waste Management. *2018 International Conference on ICT for Smart Society (ICISS)*, 1-6. DOI: 10.1109/ICTSS.2018.8550013
 - Mihaliková, E., & Lachytová, L. (2020). Analysis of Municipal Waste Separation in Slovakia and Possible Alternatives. *TEM Journal*, 9(3), 1108. DOI: 10.18421/TEM93-36
 - Mijts, E., Ballantyne, J., & Rodriguez, C. (Eds.). (2022).

- UAUCU Student Research Exchange : Collected Papers 2022. *University of Aruba, University College Utrecht*. (pp. 229-242). DOI: BNA-DIG-UAUCU-2022
- Mishra, D., Vajire, S. L., Saxena, S., Gupta, P., Saini, D. K., Srivastava, A. K., & Rao, G. M. (2022). GRUBin: Time-Series Forecasting-Based Efficient Garbage Monitoring and Management System for Smart Cities. *Computational Intelligence and Neuroscience*, 2022. <https://doi.org/10.1155/2022/2538807>
 - Mohee, R., Mauthoor, S., Bundhoo, Z. M. A., Somaroo, G., Soobhany, N., & Gunasee, S. (2015). Current status of solid waste management in small island developing states: A review. *Waste Management*, 43, 539–549. doi:10.1016/j.wasman.2015.06.012
 - Moraes, C., Blain-Moraes, S., Morell-Tomassoni, S., & Gorbet, R. B. (2021). The W-model: a pre-college design pedagogy for solving wicked problems. *International Journal of Technology and Design Education*, 31, 139-164. DOI:10.1007/s10798-019-09543-3
 - Nnamoko, N., Barrowclough, J., & Procter, J. (2022). Solid Waste Image Classification Using Deep Convolutional Neural Network. *Infrastructures*, 7(4), 47. <https://doi.org/10.3390/infrastructures7040047>
 - Pardini, K., Rodrigues, J. J., Diallo, O., Das, A. K., de Albuquerque, V. H. C., & Kozlov, S. A. (2020). A smart waste management solution geared towards citizens. *Sensors*, 20(8), 2380. <https://doi.org/10.3390/s20082380>
 - Patel, D. N., Dasari, C., Chembarpu, A., & Sasi, A. (2020). Smart Waste Segregation using ML Techniques. *International Journal of Innovative Science and Research Technology-2019*. <https://www.ijisrt.com/assets/upload/files/IJISRT19DEC624.pdf>
 - Puen, S. (2023). Design Thinking in the Catholic Church's Organizational Structures: Responding to the Wicked Problem of the Sex Abuse Crisis. *Journal of Moral Theology*, 3(CTWEC Book Series, No. 3), 72-86. <https://doi.org/10.55476/001c.72058>
 - Pereira, W., Parulekar, S., Phaltankar, S., & Kamble, V. (2019, February). Smart bin (waste segregation and optimisation). In *2019 Amity International Conference on Artificial Intelligence (AICAI)* (pp. 274-279). IEEE. DOI: 10.1109/AICAI.2019.8701350
 - Plattner, H. (2010). *An Introduction to Design Thinking PROCESS GUIDE*. Institute of Design at Stanford. <https://web.stanford.edu/~mshanks/MichaelShanks/files/509554.pdf>
 - SER (2017, December). De mogelijkheden tot the toepassen van het concept Circular Economie op Aruba. <https://www.ser.aw/pages/wp-content/uploads/2018/03/De-mogelijkheid-tot-het-toepassen-van-het-concept-Circulaire-Economie-op-Aruba-Dec-2017.pdf>
 - Shamin, N., Fathimal, P. M., Raghavendran, R., & Prakash, K. (2019, April). Smart garbage segregation & management system using Internet of Things (IoT) & Machine Learning (ML). In *2019 1st International Conference on Innovations in Information and Communication Technology (ICIICT)* (pp. 1-6). IEEE. DOI: 10.1109/ICIICT1.2019.8741443
 - Shenoy, A., Ranjitha, P., HariPriya, R., & Vinutha, C. B. (2022). Smart Waste Segregation System using Convolutional Neural Networks. *Journal of Electrical Engineering*, 4(2), 86-99. <https://irojournals.com/iroeea/V4/I2/03.pdf>
 - Shi, C., Tan, C., Wang, T., & Wang, L. (2021). A waste classification method based on a multilayer hybrid convolution neural network. *Applied Sciences*, 11(18), 8572. <https://doi.org/10.3390/app11188572>
 - Sidhu, N.S., Pons-Buttazzo, A., Muñoz, A., & Terroso-Sáenz, F. (2021). A Collaborative Application for Assisting the Management of Household Plastic Waste through Smart Bins: A Case of Study in the Philippines. *Sensors (Basel, Switzerland)*, 21. <https://doi.org/10.3390/s21134534>
 - Sreelakshmi, K., Akarsh, S., Vinayakumar, R., & Soman, K. P. (2019, March). Capsule neural networks and visualization for segregation of plastic and non-

plastic wastes. In *2019 5th international conference on advanced computing & communication systems (ICACCS)* (pp. 631-636). IEEE. DOI: 10.1109/ICACCS.2019.8728405

- Trash2Cash (n.d.). WELCOME TO TRASH2CASH ARUBA - The Waste Management Virtual Forum. <https://trashtocasharuba.org/index.html#About-Us>
- United Nations Environment Programme (UNEP) (2019). Small Island Developing States Waste Management Outlook. <https://wedocs.unep.org/20.500.11822/27683>
- Verma, S., Suri, S., Pundir, V., & Chakarvarti, P. K. (2020). Waste segregation and waste management using smart bin: a review. In *International Conference of Advance Research & Innovation (ICARI)*. <http://dx.doi.org/10.2139/ssrn.3636024>
- Vu, D. D., & Kaddoum, G. (2017, November). A waste city management system for smart cities applications. In *2017 Advances in Wireless and Optical Communications (RTUWO)* (pp. 225-229). IEEE. DOI: 10.1109/RTUWO.2017.8228538
- Workgroup Waste Processing Aruba 2017-2018 (WWPA). (2018, December). Final Report Integrated Solid Waste Management Aruba. <https://deugdelijkbestuuraruba.org/wp-content/uploads/2022/05/Final-Integrated-Report-Solid-Waste-Management-Aruba.pdf>
- Zhang, L. P., & Zhu, Z. P. (2020). Can smart waste bins solve the dilemma of household solid waste sorting in China? A case study of Fuzhou City. *Polish Journal of Environmental Studies*, 29(5), 3. <https://doi.org/10.15244/pjoes/115868>



Eleomar R.C. Mateo, University of Aruba

I could carry out my research.

I would want to use this opportunity to express my most heartfelt thanks and appreciation to everyone who has helped me in any way during the process of developing my thesis. To begin, I would want to express my gratitude to my company, Ace firm, for allowing me to take the time and make the necessary arrangements so that I could carry out my research.

In addition, I would like to express my gratitude to Eric Mijts and Kryss Facun for the significant contributions that they have made to this project. I am thankful for the help that I received from them, as the completion of this paper would not have been possible without their contribution of time, skills, and ideas.

In conclusion, I would want to express my gratitude to my family and friends for providing me with unflinching support and encouragement during the entirety of

this process. Because of their unwavering support and encouragement, I've been able to maintain my motivation and stay focused on this undertaking.

I would like to use this opportunity to extend my most sincere gratitude to each person who has helped me in the preparation of my thesis. Thank you for your support, advice, and encouragement.



Interdisciplinary and multidisciplinary approaches to sustainable development

Small Island, Big Challenge

A Reflection on food security in ‘Small Island State’ with Aruba as case study

Eleomar R.C. Mateo

Summary

Aruba is a small island nation, which makes it challenging to ensure that its residents have access to sufficient food supplies that are only provided by local farmers. This paper, presents the various ways in which innovation may be utilized to enhance the effectiveness, sustainability, and adaptability of the island’s food system. It is vital to have access to suitable food that is both safe and nutritious in order to preserve one’s physical and mental health, as well as to reduce poverty and enhance economic growth. This access is also necessary in order to maintain national financial stability.

In addition to this, a sustainable food system assists in mitigating the adverse effects that crises have on people’s health as well as their capacity to create a living for themselves and their families. Promoting healthy eating habits, expanding access to clean water and sanitation, and establishing sustainable food systems are all important steps toward attaining both the aim of achieving food security and the goal of achieving sustainable development, which are intimately intertwined with one another. Food security is essential to human survival and well-being, but small island states such as Aruba have challenges due to limited land resources, restricted access to financing and

technology, and climate change. These factors combine to make it difficult to meet the need for food. Producing and distributing food is made more complex because of all these forces working together. To address these problems and find answers, Aruba aims to increase its food production lower its food waste and implement policies that support sustainable agriculture.

Aruba has to increase the amount of food produced on the island and make additional progress toward the construction of sustainable food systems in order to reduce its reliance on food imported from other countries and keep food costs stable.

Furthermore Aruba has also developed novel approaches to enhance food security, decrease reliance on food imports, and fortify resistance to the effects of climate change. Seed banks are responsible for the preservation and reproduction of historic crop kinds, while climate-smart agriculture seeks to raise agricultural productivity while reducing emissions. Aquaponics farming is rising in popularity due to global supply disruptions and high food prices. Aruba aims to take measures to minimize its emissions of greenhouse gases and adapt its practices of land management to lessen the impact of climate change. Increased food security has a substantial impact on society and the economy, leading to improvements in health, economic prospects, and social cohesion.

Foreword

Small island states like Aruba, which are highly dependent on food imports and sensitive to economic shocks like natural disasters and global price changes, face a significant challenge when it comes to ensuring that their populations have access to sufficient and safe food supplies. Almost 110,000 people make their home on the island of Aruba, which can be found in the southern part of the Caribbean Sea. The island is a well-known destination for tourists. Aruba is a small island, yet it has a complex food system that incorporates various stakeholders, such as farmers, food producers, distributors and importers, merchants, and consumers. This is despite the fact that Aruba is a relatively small island.

In recent years, the government of Aruba has acknowledged the significance of ensuring the nation's food supply and has taken measures to enhance the food distribution network on the island. As part of these efforts, local agriculture has been promoted, food production has been increased, and reliance on imported food has been decreased. On the other hand, ensuring that residents of Aruba have access to sufficient food is a difficult and ongoing task that calls for creative solutions.

This paper presents the role of innovation in the process of developing food security in Aruba. To be more specific, it will investigate the possibility of technological, social, and organizational innovations to increase the effectiveness, sustainability, and resilience of the island's food system. In addition to this, the paper discusses the difficulties and potential benefits involved with putting these new ideas into practice within the framework of Aruba's status as a small island state.

This paper constitutes the framework for a broader research project that will be carried out utilizing a mixed-methods approach, which will include interviews with key stakeholders in the Aruban food system, surveys of farmers

and consumers, as well as an examination of secondary data sources. The results of this research will make an important contribution to the expanding body of literature on the topic of food security in tiny island states, as well as provide valuable insights into the potential of innovation to help solve this pressing problem. In the end, that research will provide recommendations for policymakers, farmers, and other stakeholders in Aruba and other small island governments who are looking to improve their food systems and attain food security. This research project aligns with the broader Food Security and Economic Diversification agenda of the SISSTEM program.

1 The Importance of Food Security

Access to adequate, safe, and nutritious food is essential for maintaining physical and mental health, and this is what we mean when we talk about food security. For one's health, productivity, and general happiness, having access to sufficient and healthy food is a fundamental human right. Assuring that individuals always have access to the food they need means that they are less likely to be hungry, which in turn reduces poverty and boosts economic growth. Ensuring environmentally and socially sustainable food production and distribution networks is crucial for attaining sustainable development.

In addition, a resilient food system is essential in times of crisis, such as natural disasters, conflicts, or pandemics, because it helps to alleviate the effects of such crises on people's health and livelihoods. To guarantee a future of health, prosperity, and sustainability for all, establishing food security is a critical objective for individuals, communities, and nations.

1.1 Consequences of not having access to adequate, safe, and nutritious food

When people are exposed to structural food-insecurity, it can have far-reaching effects. Malnutrition has several

immediate consequences, including short stature and severe weight loss. Those with compromised immune systems due to malnutrition are more likely to contract infectious diseases and experience other health problems. Children who are malnourished often experience negative impacts on their cognitive and physical development that persist throughout adulthood. Reduced productivity and higher healthcare expenditures due to hunger and malnutrition can stifle economic growth and development. In places where food shortages are persistent, food insecurity is a contributing factor to social discontent and instability.

On a personal level, being hungry or poor might make it difficult to advance out of a downward spiral of poverty. Food insecurity disproportionately affects low-income families and members of historically oppressed groups, such as women, children, and members of minority communities.

2 Sustainable Development and Food Security: Mutually Reinforcing Relationships

Sustainable development and food security are two interconnected and vital challenges for the well-being of individuals and communities globally. The goal of sustainable development is to foster economic growth and social progress while protecting natural resources for future generations. Food security, on the other hand, refers to the availability, accessibility, and utilization of food to ensure that all individuals have sufficient, safe, and nutritious food to meet their nutritional requirements.

Agricultural security and sustainable development are inextricably intertwined, and there is rising understanding of the need for sustainable agricultural systems in fostering food security. Agroforestry, crop rotation, and organic farming are

examples of sustainable agriculture methods that can improve soil health, reduce greenhouse gas emissions, and raise crop yields, contributing to both sustainable development and food security (Food and Agriculture Organization of the United Nations, 2021). Furthermore, efforts to improve access to safe drinking water, sanitation, and health care can improve nutritional status and reduce the risk of foodborne illness (Organization, Drinking water, 2018)

Food insecurity is associated with poverty, poor health, and malnutrition, all of which can have long-term consequences for economic growth and social progress (Food and Agriculture Organization of the United Nations, 2021). The United Nations Sustainable Development Goals (SDGs) emphasize the importance of food security and sustainable development. By 2030, SDG 2 seeks to “end hunger, achieve food security and improved nutrition, and promote sustainable agriculture” (Nation, 2015). To achieve this goal, efforts must be made to support sustainable food systems, improve food production and distribution, and expand access to healthy food.

To summarize, sustainable development and food security are inextricably linked, and efforts to improve one can have a positive impact on the other. Improving sustainable food systems, expanding access to clean water and sanitation, and encouraging healthy eating habits are all key steps toward attaining both sustainable development and food security.

3 Food security and the challenges faced by small island states.

Sustainable development small island states are heavily reliant on food security, which is hindered by their size, geography, and limited resources. Achieving food security is a challenging task for small island states such as Aruba. The limited land resources of small island states such as Aruba

pose a significant challenge to their agricultural production capacity. Less than 10% of Aruba's 193 square kilometers of land is arable. The country's high dependence on food imports is also due to limited land availability, which poses a significant obstacle to agricultural production and self-sufficiency.

3.1 Food import of Aruba

The goal of achieving food security through local food production is significant for several countries, including Aruba. Aruba's population is approximately 106,000 people, and it is a small island nation situated in the southern Caribbean Sea. Up to 90% of Aruba's food is imported, indicating a heavy reliance on imported food. Aruba's heavy reliance on imports of food makes it vulnerable to global supply disruptions and can result in high food prices for consumers. The total value of imports to the free circulation area and free zone of Aruba between January 2017 and December 2022 was approximately Afl 3.5 billion, as per data obtained from the CBS Aruba website, the heavy dependence of the island on imported goods leaves the country vulnerable to external disruptions and economic shocks. (Aruba, 2022)

Food import prices increased significantly by 20.8% in 2022 compared to the previous year, as reported by the Central Bureau of Statistics (CBS). The budget of Aruban citizens, especially those with limited financial resources, has been significantly impacted by this increase. The affordability of basic food items has become more challenging for households due to the increasing prices of food imports. The impact of rising food prices is especially significant for low-income households that are already facing financial difficulties. The increased cost of imported foods has created a challenge for families in selecting healthy food choices, as these options are often pricier than less nutritious alternatives.

Aruba can improve its food security by increasing ecologically sound local food production and promoting

sustainable food systems in response to the rise in food import prices. The creation of a more resilient food system for Aruba's citizens contributes to the stabilization of food prices by reducing dependence on imported foods. The government can support vulnerable populations by implementing policies and programs that provide access to healthy and affordable food options.

Another limiting factor for small island states such as Aruba in enhancing their agricultural production is the limited access to finance and technology. Attracting foreign investment or finance is challenging due to limited resources and market size. Small island states face challenges in modernizing their agricultural systems due to the high cost of technology and maintenance. (Tschirley, 2019)

Aruba's food security is significantly threatened by the impact of climate change. The impact of climate change on agriculture can lead to a decrease in food production and an increase in food prices due to the dependence on the international food market.

The government's policy (Boyer, 2022) aims to connect local farmers with the consumer, for example the hotel industry. This will boost domestic production through measures like incentivizing farmers and advocating for hydroponic and aeroponic farming techniques. (Cairo, 2021)

3.2 The Effects of Climate Change on Food Supply and Mitigation Strategies

Aruba and other small island societies are especially vulnerable to the adverse effects that climate change is going to have on the availability of food. Aruba has a small land area and relies significantly on food that is imported; as a result, the island is vulnerable to fluctuations in the cost of food brought on by climate change's effects on the global food market. Changes in climate may also result in an increase in the frequency of extreme weather events such as hurricanes and droughts, both of which may influence

crop yields and the fertility of soil. Moreover, rising sea levels and saltwater intrusion can contaminate freshwater resources, making it more difficult to irrigate crops. This is a consequence of how much the sea level is rising.

To lessen the impact that climate change will have on the availability of food in Aruba and other small island states, it is vital to implement both adaptation and mitigation techniques. Improved water management procedures, the introduction of drought-resistant crop types, and the use of conservation agricultural practices are all examples of potential adaptation measures. The government of Aruba has taken several steps to adapt to the effects of climate change, including the construction of desalination plants to provide freshwater for irrigation and the development of initiatives to encourage environmentally responsible agricultural methods. (Aruba's, 2019)

Reducing greenhouse gas emissions by using renewable energy sources and changing land use practices are two examples of mitigation actions that might be implemented in Aruba to mitigate the effects of climate change on the country's food supply. Green Aruba was established in 2012 with the mission of converting the entire island of Aruba to run solely on renewable energy sources by the year 2020. Under the context of this initiative, the development of wind and solar energy projects, in addition to measures to increase energy efficiency, are included. (Department of Economic Affairs, 2020)

4 Food Systems Analysis: Identifying Challenges and Opportunities

When it comes to the matter of food security, small island states have a special set of issues. These difficulties are principally caused by their restricted land areas, resources, and susceptibility to the effects of climate change. On the other hand, there are novel approaches that can be utilized

to enhance the food security of tiny island states. Mentioned below are the systems that are mostly used on the island:

4.1 Aruba's most common agricultural systems

These creative solutions have the potential to assist small island states in enhancing their food security, decreasing their reliance on food imports, and increasing their resistance to the negative effects of climate change. However, for these solutions to be successful, they need to be adapted to the circumstances of the local area and supported by policies and investments that encourage the growth of sustainable agricultural and rural areas.

The agricultural sector of Aruba is quite small and has considerable obstacles, such as a lack of agricultural land, high input costs, and restricted water resources. Additionally, there is a shortage of water resources. In spite of these obstacles, Aruba is currently putting into place a number of sustainable agricultural practices in order to increase the amount of food that is produced on the island and lessen its reliance on food that is brought in from outside.

Hydroponics, in which plants are grown without the use of soil but rather in nutrient-rich water solutions, is one of the most prevalent forms of sustainable agriculture used in Aruba. This method is particularly well-suited to Aruba's arid climate, as it takes less water than traditional farming methods and can be used to grow crops in tiny places. As a result, this method is particularly well-suited to Aruba's arid climate.

Aquaponics, which mixes hydroponics with fish farming, is another sustainable agriculture technology that is gaining popularity in Aruba. Aquaponics is a hybrid of aquaculture and hydroponics. The excrement from the fish is utilized to fertilize the plants in this system, and the plants, in turn, are responsible for purifying the water that the fish swim in. This self-contained, closed-loop system is not only highly productive but also requires only a modest amount of space to cultivate fish and vegetables.

5 Food Security and Health: The Importance of Adequate and Nutritious Food

A non-profit organization in Aruba called ‘Fundacion pa nos Comunidad’ works to better the lives of less fortunate individuals through donations. They prioritize giving food baskets to families in need as one of their primary goals.

‘Fundacion pa nos Comunidad’ currently delivers food baskets to 200 houses each month. These food baskets include staples like fresh produce, canned goods, rice, beans, and pasta. To make sure that the food baskets are both wholesome and reasonably priced, the organization maintains tight ties with neighborhood grocers.

The food basket initiative from ‘Fundacion pa nos Comunidad’ is intended to combat food insecurity in low-income households in Aruba. The charity is aware that many families find it difficult to put food on the table, especially in times of adversity or disaster. Fundacion pa nos Comunidad wants to lessen the burden of food insecurity and guarantee that families have access to wholesome food by offering free food baskets.

‘Fundacion pa nos Comunidad’ offers a variety of different programs and services, such as educational initiatives, health programs, and neighborhood festivities, in addition to distributing food baskets. These programs aim to advance social inclusion, enhance health outcomes, and boost the general wellbeing of Aruba’s most vulnerable groups.

In general, the food basket program run by ‘Fundacion pa nos Comunidad’ is essential in tackling food insecurity and advancing sustainable development in Aruba. The charity can help families in need and make sure that no one goes hungry by collaborating closely with neighborhood stores and local residents. (Aruba F. p., 2023)

Malnutrition can be caused by inadequate diets, resulting in delayed development, deficient immune systems, and a greater vulnerability to diseases like anemia, blindness, and cognitive deficits.

Adequate and nutritious diets play a crucial role in economic and social development, in addition to their impact on health outcomes. The importance of proper nutrition is highlighted by its role in facilitating children’s learning and performance in school, as well as enabling adults to be productive and make meaningful contributions to their communities. The support of sustainable agriculture and food systems, as well as the reduction of poverty and hunger, can be achieved through good nutrition. (Organization, Nutrition, 2021)

6 Conclusion

In conclusion, the issue of food security in Aruba is a complicated one that is influenced by a variety of factors such as the limited amount of land for agriculture, the reliance on imports, and the shifting patterns of the weather. Through a variety of initiatives, including the promotion of sustainable agriculture, the encouragement of local food production, and the implementation of policies to reduce food waste, Aruba has made significant progress toward improving the island’s overall food security.

However, there is still a lot of work to be done to guarantee that all Aruban residents have access to food that is both healthy and safe to eat. To ensure that all citizens have access to food that is sufficient, nutritious, and affordable, the government, along with the private sector and civil society, must continue to collaborate to address the fundamental factors that contribute to food insecurity, such as poverty and inequality, and to develop creative and long-term solutions to the problem.

In addition, it is essential to acknowledge the possible impact on Aruba’s food security of variables external to

the country, such as alterations in the climate and general economic tendencies around the world. To guarantee that the island's food systems continue to be resilient and sustainable despite these problems, it will be essential for the government and other stakeholders to maintain alertness and adapt to the ever-changing circumstances.

Overall, although there are several initiatives aiming at improving food security in Aruba, it will require continued commitment and collaboration from all stakeholders to build a truly sustainable and equitable food system on the island.

7 References

- Aruba, C. B. (2022, November 15). *Central Bureau of Statistics Aruba*. Retrieved from Central Bureau of Statistics Aruba: <https://cbs.aw/wp/index.php/2022/11/15/total-imported-value-to-aruba-by-food-segments-2015-2021-ytd/>
- Aruba, F. p. (2023, 04 28). *Fundacion pa nos comunidad Auba*. Retrieved from <https://www.fpnc.aw/about/>
- Aruba's, A. T. (2019, December). Retrieved from Department of Economic Affairs, Commerce and Industry (DEACI): www.deaci.aw
- Boyer, M. E. (2022, November 16). *The World Bank*. Retrieved from Building Aruba Food Security During Pandemic of Covid 19 and beyond: <https://documents.worldbank.org/en/publication/documents-reports/documentdetail/099055001092318003/p17123706194860f009da60c5389ccf3a89>
- Cairo. (2021). *Regional Overview Of Food Security And Nutrition*. Retrieved from <https://www.fao.org/3/cb7495en/cb7495en.pdf>
- Department of Economic Affairs, C. a. (2020, January). *Nos Plan , Nos Futuro*. Retrieved from <https://www.deaci.aw/wp-content/uploads/2020/11/FINAL-NSP-REPORT-STRATEGY-10202020.pdf>
- Despommier, D. (2009, November 01). *Growing Skyscrapers: The Rise of Vertical Farms*. Retrieved from Scientific American: <https://www.scientificamerican.com/article/the-rise-of-vertical-farms/>
- *Food and Agriculture Organization of the United Nations*. (2021). Retrieved from FAO: <https://www.fao.org/state-of-food-security-nutrition/2021/en/>
- Garrity, D. (2004). *Agroforestry and the achievement of the Millennium Development Goals*. Retrieved from World Agroforestry Centre: <http://apps.worldagroforestry.org/downloads/Publications/PDFS/ja04026.pdf>
- Nation, U. (2015). *The 2023 Agenda for Sustainable Development is Transforming our globe*. Retrieved from

<https://post2015.un.org/transformingourworld>

- Nations, F. a. (2016). *THE STATE OF FOOD AND AGRICULTURE* . Retrieved from fao.org: <https://www.fao.org/3/i6030e/i6030e.pdf>
- Organization, W. H. (2018, December 27). *Drinking water*. Retrieved from <https://www.who.int/en/news-room/fact-sheets/detail/drinkingwater>,
- Organization, W. H. (2021). *Nutrition*. Retrieved from World Health Organization: https://www.who.int/health-topics/nutrition#tab=tab_1
- Program, U. N. (2018). *Annual report* .
- Tschirley, D. (2019). A sustainable and resilient food system for small island developing states.
- Webb, P. &. (2012). *Support for agriculture during economic transformation: Impacts on poverty and undernutrition*. Boston : Friedman School of Nutrition Science and Policy.



Noemi Pérez Kluin, University College Utrecht

It sparked my interest, but it also scared me.

When one of my teachers at UCU talked to me about the program, I had never heard about it. It sparked my interest, but it also scared me, as it involved being in a completely unknown place and doing research by myself. However, in the span of a week I got informed and applied. As an islander, I thought this would be awesome, more so learning about sustainability on small islands. It made me think about home, the Canary Islands, and all the valuable things I could learn in Aruba.

When it was time to go, I was extremely nervous and excited. Going to the Caribbean, the first time crossing the Atlantic and leaving Europe was like wow, something I thought I would never do. Arriving in Aruba, it was so different to home, but there were small things that were familiar, like the chill vibes. Not feeling like you always have to rush somewhere and live stressed, like at UCU.

Starting the research was complicated. I felt lost, I was unsure about my topic and contacting the stakeholders, especially because I wanted hotels to collaborate with me for the implementation of my study. However, in the end, I found my way. I just needed to get out there and start sending many emails and fight against my shyness and insecurity. Once the meetings were scheduled, they were all eager to help and work with me, which I am very grateful about. Three weeks before ending the program, I cut my stay at Aruba short. It was a difficult decision to make but due to personal circumstances, it was the best option for me at the time. I felt extremely supported by everyone, and I greatly appreciate that. Nothing turned out as I had planned at UCU, but that is 100% normal and okay. Writing this I still have a long road with thesis, but I will get there. Going to Aruba and participating in the program was very worth it and I would recommend it so much. Also, the University of Aruba is such a cute place

and the cheese pastechi's from the cafeteria is something I will miss so much.

Not all was research, and the most valuable experience for me was meeting people that made Aruba feel more like home. Our nights out at Gusto and Moomba, beach times, taco tuesdays, finding our own way around, our trip to Colombia and all our improvised but awesome plans there: a lot of food, a nearly missed ferry to the desert and more. You meet people unexpectedly, and they became part of this experience. Fun fact: I met someone from my island. The world is such a small place, what are the odds.

I bring very nice memories back home with me: I learned, discovered, and travelled. I think this is something you must experience at least once in your life, and I am so glad that I did, and that I took that step. The fact that I got a tattoo to symbolize this experience says a lot about what it meant for me. I hope to be back on that side of the world, the Caribbean and South America are beautiful.

From swimming with turtles in Aruba, to road trips in the Colombian desert and wild sea lions in Uruguay, this has been an unforgettable experience that made me grow so much personally and I wouldn't change a single thing.



Behavioural Interventions in Hotels in Aruba

Can social norms encourage towel reuse and the use of refillable water canteens?

Noemi Pérez Kluin

1. Introduction

The main issue with tourism in Aruba is that it has reached and surpassed its carrying capacity. This means that its resources, due to the massive influx of visitors, are being stretched “beyond sustainable levels” (Department of Economic Affairs, Commerce and Industry Aruba, 2019; SDG Aruba, 2017). For example, on a busy day there can be around 30,000 visitors on the island (Sustainable Travel International, 2019) and 942,487 arrivals in the year 2021 (Central Bureau of Statistics, 2021). As the tourism sector keeps growing, there will be an increasing demand for water despite its scarcity (Foley et al., 2022), as well as an increase in the production of waste. According to a report from Aruba Tourism Authority (ATA), 30,000-150,000 kilotons of waste was produced annually in the year 2017 (Sustainable Travel International, 2019). Only a small proportion is recycled due to the limited recycling and disposal possibilities on the island. For example, in the year 2013, 88,132 tons of waste was produced where 9,695 tons was recycled, 11% (Index Mundi, n.d.). The rest was mainly disposed of at the landfill at Parkietenbos (Workgroup Waste Processing Aruba, 2018), up until its closure at the beginning of 2023. Relating it to tourism, as the carrying capacity is at its limit, as discussed previously, this means that the collective behaviour of such a big number of visitors has impacts: “The concept of responsible behavior, respecting the environment,

controlling waste, keeping the beaches and urban areas clean, is insufficiently accepted, and adopted. The link between a clean and healthy environment and the tourism sector is inadequately understood” (SDG Aruba, 2017).

Nudges are placed in a person’s environment to serve as cues to influence behaviour without enforcing it (Weßel et al., 2019). This paper presents the literature study and description of methodology for a study that aims to apply this concept to the hospitality industry, to encourage tourists in hotels to participate in more pro-environmental or sustainable behaviours through messages placed within hotel rooms. The goal is to nudge guests at two different resorts in Aruba to reuse towels, as well as make more use of the refillable water canteens.

There is not a lot of research on the effectiveness of nudges to encourage more sustainable behaviours in the hospitality sector, as most research on nudges is in health-related fields (Wee et al., 2021). Therefore, it is important to replicate this research to develop a more effective way to communicate the need for pro-environmental behaviour in hotels: “studies that measure real behaviour are notably absent” (Dolnicar & Ring, 2014, p. 43). There is a gap between pro-environmental attitudes and behaviours, which means that these attitudes are not always “translate[d] into environmentally friendly behaviours” (Blöse et al., 2015, p1). This is relevant in the

field of tourism due to its hedonic nature, as tourists often leave part of their sustainable practices at home (Dolnicar et al., 2019). Nudges can be used to encourage them in the right direction.

Hotels are the principal places of hedonic tourism, and this term refers to how tourism is pleasant in nature, especially in island vacations where these tend to be marketed as paradisiacal. An example includes the one happy island slogan for the island of Aruba. In turn, this can lead to more unsustainable behaviours because relaxed vacations are often associated with more resource intense (Gossling et al., 2019) behaviours, such as increased consumption. Examples include water or energy, as a fixed price is paid for the hotel in advance, instead of accumulative bills at home. Additionally, the touristic areas are tailored to the tourist experience and therefore can alienate local struggles from tourism's sustainability. Due to these reasons and the lack of economic incentives to change behaviour (Dolnicar et al., 2020), there is a need for research to focus on this as well as on the existing research gap in Nudge theory in the tourism field. Furthermore, the Sustainable Development Goal number 12 highlights the need for sustainable consumption and production which is exactly what this paper aims to address in the context of hotels and tourism ("The 17 Goals", n.d.).

The research question that this paper aims to address is: Can social norm nudges encourage the use of refillable water canteens and towel reuse?

The sub-questions are the following:

1. Why is there a need to reduce (plastic) waste and water use in Aruba?
2. How can social norms influence decision making?
3. How can social norms influence decisions by tourists in the hospitality sector?

2. Literature Review

2.1 Behavioural Economics & Nudge Theory

Nudge theory is from the field of behavioural economics. It states that people make decisions based on biases and the context in which they are made, opposite to the "homo economicus" view where people are always rational (Reisch & Zhao, 2017). Nudges are placed in a person's environment to serve as cues to influence behaviour without enforcing it (Weßel et al., 2019). In other words, changing the environment in which choices are made (Thaler & Sunstein, 2008), the so-called choice architecture, can alter behaviour in predictable ways without restricting behavioural options. Choice architecture is the environment in which choices are made (Thaler & Sunstein, 2008). Kahneman's (2003) research proved that people base their decisions on two systems. System 1 is automatic and based on impulse and biases, whereas System 2 requires more effort and more in-depth thinking. Nudges target the first system and encourage behavioural change (Wee et al 2021).

There are many types of nudges that can be used. This study focuses on social norms, as the way in which the message is delivered has an impact on how effective it is (Ruokamo et al., 2022).

2.2. Social Norms

A commonly used nudge calls on social norms or comparisons where people look towards others to identify what the norm is, thus how most people behave (Karlsen & Andersen, 2019). As a result, their behaviour is influenced by this. Social Identity Theory (Tajfel, 1979) explains behaviour in social groups and how a person's self-concept depends on the group they are part of and the positive identity they want to have. Therefore, following the norms of that group is important and this can be used in the form of nudges by generating a social norm in the context of the hotel they are in (Dolnicar, 2020). This would encourage them to follow said behaviour.

2.2.1 Decision Making

Research on the influence of social norms on behavioural decision-making is relevant for this paper, as its aim is to nudge tourists within hotels in Aruba to behave more sustainably. There are different types of social norms: descriptive, using the word “many”, and injunctive, using the word “should”. Descriptive norms describe what others usually participate in whilst the latter refers to behaviours that others usually approve of (Gillingham & Tsvetanov, 2018). Previous literature shows that descriptive norms are most effective in encouraging individuals to act consistently with others (Sherif, 1937). A way in which social norms can be employed is through comparative feedback or peer comparison. This means that individuals are compared to others that are within a particular group together. An example includes a district or residential area (Milford et al., 2015; Ruokamo et al., 2022). Comparisons can show that a certain behaviour is common in the social group (Brekke et al., 2010), and part of their self-concept. As a result, it can develop the notion that the individuals that make up this group should participate. Milford et al. (2015) used social comparisons with the aim to increase recycled waste in households and Ruokamo et al. (2022) to reduce residential electricity consumption. Additionally, they used tips and information for possible improvements as well as personal and environmental benefits (Milford et al., 2015; Ruokamo et al., 2022; Gillingham & Tsvetanov, 2018). There is a finding that sharing information increases knowledge and has a stronger effect (Iler & Kashyap, 2011) than the social norm by itself, as the appropriate behaviour is informed by the norm, and the information guides how it should be changed. The methods that were used by Milford et al. (2015) and Ruokamo et al. (2022) were letters and newsletters sent to houses, respectively, and an online service for the latter. Thus, the methods and aims were similar. The letters contained feedback on the personal level of recycling relative to the rest of the district, and were personalized by addressing the household by name and signing off as the individual who had initially contacted them (Milford et

al., 2015). This shows it wasn't a general letter sent to all households. The personal touch aspect corresponds to previous behavioural studies that found that it is proof of time investment and will likely result in reciprocation and participation in the request (Garner, 2005) leading to better results (Ruokamo et al., 2022). The newsletters were an alternative for those households that were not subscribed to the online service platform (Ruokamo et al., 2022). The results were very similar and significant for both studies. The combination of the comparative feedback and the tips (Milford et al., 2015; Ruokamo et al., 2022) led to an increase in recycling by 2%, which was the strongest effect recorded (Milford et al., 2015). It also reduced electricity consumption up to 10% in those houses that were more involved in tracking their own consumption (Ruokamo et al., 2022).

The previous finding leads to the additional conclusion that houses that had a major interest in the behaviour being targeted showed the best responses to the nudges: those with an interest and who are involved in recycling (Milford et al., 2015), those interested in energy consumption issues (Ruokamo et al., 2022), as well as places with more ties to cleaner energy or more recent energy campaigns (Gillingham & Tsvetanov, 2018). Similarly, Kormos et al. (2015) found that the main predictor for their target behaviour, the reduction of private use of cars, was past behaviour. The treatment conditions were a low and high degree of descriptive social norms, in terms of reporting other people's car use. In the low condition, other people's use of private cars was underrepresented and in the high condition, this was overrepresented. As the strength of the social norm increased, so did reduction behaviour. However, people's habits prevailed in determining behaviour despite the norms (Kormos et al., 2015). Furthermore, socio-demographic variables also moderated the effect of the nudges on behaviour. These include higher income, bigger households (Jenkins, 2003), higher education (Reschovsky, 1994) and gender, as women recycle more (Milford et al.,

2015). They were measured and their effect on the outcome of the treatment conditions were isolated by the authors. These findings show the moderating role of contextual variables on the effects of nudge, which is also present in the following study by Gillingham & Tsvetanov (2018), where the nudge was more effective in rural areas, due to the greater social ties, which enabled a greater potential for the effects of social norms.

Gillingham & Tsvetanov (2018) use a similar approach as Milford et al. (2015) and Ruokamo et al. (2022). They use a social norm, mentioning how other residents regularly have audits performed in their households. This is combined with information on the potential of saving money and benefits to the environment if consumption is reduced, together with a personal touch. The authors aimed to increase the following-through with residential energy audits after an initial commitment, which is a house visit that has already been scheduled previously. Therefore, the goal was to encourage these scheduled visits to go through as planned (Gillingham & Tsvetanov, 2018). However, the differences with the studies by Milford et al. (2015) and Ruokamo et al. (2022) are that the norm used by Gillingham & Tsvetanov (2018) is specifically a descriptive norm, and that the latter added salience to the messages. This is done by issuing a reminder about the date of the visit for the audit. This leads to a greater likelihood to participate, and the probability of participation on a given day increases by 1.1% (Gillingham & Tsvetanov, 2018). Comparing it to the previous studies that follow a similar method, the results can be considered consistent to each other, as they show similar percentage changes: 2% (Milford et al., 2015) and 1.1% by (Gillingham & Tsvetanov, 2018). Ruokamo et al. (2022) showed the greatest change, where electricity consumption was reduced up to 10% (Ruokamo et al., 2022).

2.2.2 Normative and provincial nudging in the hospitality sector

Normative strategies have been researched in the hospitality

sector to investigate whether social norms can encourage more pro-environmental behaviours by guests at hotels, like towel reuse. There are different types of descriptive norms that can be used, which include provincial and global norms. The latter refers to a norm for the whole hotel and its guests, in the context of the hospitality sector. The first, provincial norms, are the most common, where the immediate surroundings are used as a reference group. For example, the specific room the individual targeted is staying at (Goldstein et al., 2008). The difference between both types of descriptive norms is the reference group. This is the group the guest will compare itself to when reading the message. The amount of similarity between the target person and the reference group is said to affect norm adherence (Goldstein et al., 2008). Comparing the two types of norms, provincial and global, is important to identify which one is more effective in eliciting more towel reuse behaviour (Goldstein et al., 2008). Goldstein et al. (2008) compared descriptive norms to the control, which was a message that highlighted the importance of protecting the environment without including any type of descriptive norm. The sign that reflected the norm led to a significant towel reuse of 44.1% compared to 35.1% from the control (Goldstein et al., 2008). For the second experiment, specifically global and provincial norms were investigated. The results show that the latter, where the specific room condition was highlighted, led to the highest level of reuse by 49.3% (Goldstein et al., 2008). Goldstein et al. (2008) carried out a similar study the year before where there were two additional tests done that tested global and provincial norms: “almost 75% of guests” and “75% of guests who stayed in this room (#xxx)”, respectively. The results were the same, as the provincial norms led to higher towel reuse by 49.3% than the global one (Goldstein et al., 2008).

From the previous study, provincial norms were found to be the most effective, a finding that is repeated by other authors. In the island of Gran Canaria, Gossling et al. (2019) compared a modified or simple message

with a comprehensive message across 7 hotels. The latter consisted of provincial norms: “82% of all guests in room [room number] reused their towels” (Gossling et al., 2019, p. 276), leading to an increase of towel reuse by 6.8% and of linen by 1.2% compared to the standard message (Gossling et al., 2019). The standard is a message where the hotel’s aim of towel reuse is highlighted and instructions are given, but no nudging technique is used (Gossling et al., 2019). Reese et al. (2014) conducted a similar study and reached the same conclusion that provincial norms have a more significant effect on towel reuse, through the use of “75%” as an indicator for the norm as well as the same type of control message. Similarly, Terrier & Marfaing (2015) used the following message: “75% of them choose to reuse their bath towels” (Terrier & Marfaing, 2015, p. 12). Therefore, it can be concluded that within social norms, the provincial type that are included in messaging have a positive effect on towel reuse behaviour as said norms represent sharing a common goal with an individual’s social group (Stanne et al., 1993). Also since they “have shared the same experience of staying in that room with relatively few people [,they] may feel a close association with those individuals” (Goldstein et al., 2008, p. 149). However, an interesting finding in this case is that there was no significant difference found between the global norm and standard condition or control. In the previous studies, both the global and provincial norms have been more effective than the standard. This different result reinforces the fact that the same room reference group is the most effective nudge in terms of social norms. Also, it shows that this study’s finding, compared to the previous ones, may be due to the additional factors that also play a role in mediating the effects of the nudges on behaviour. In this case, “collection of individual data [was] not possible” (Reese et al., 2014, p. 98), which means that it wasn’t possible to determine if there are other variables which could explain this finding. Thus, it is important to thoroughly measure all variables in order to better explain the findings and reach more complete conclusions.

However, apart from testing provincial norms only, Terrier & Marfaing (2015) also tested a different nudge, commitment, and its combination with the provincial norm. In this experimental condition, there was a request written in the message asking for guests to put a hanger on the door of the room if they wanted to participate in the towel reuse program. This is considered a “preparatory behaviour” (Terrier & Marfaing, 2015, p.12), where guests have made an initial commitment. It was hypothesized that this would lead to a greater number of people following-through with reusing towels, when in reality guests “almost never carried out” (Terrier & Marfaing, 2015, p.13) said behaviour. The isolated nudges led to a higher rate of reuse than their combined use, where there were no significant differences between the commitment or social norm nudges (Terrier & Marfaing, 2015). This means that the request for the preparatory behaviour is not needed to create a commitment to reuse towels. This finding shows that isolated nudges, where different types of nudges are not combined in the same message, may have a greater effect in encouraging the targeted behaviour.

As mentioned with the Reese et al. (2014) paper, there are also other variables that influence how effective nudges are on different groups of people, which include returning visitors, the differing attitudes between nationalities, as well as hotel type and room type (Gossling et al., 2019; Terrier & Marfaing, 2015). Repeat visitors were more participative, which could be explained by a greater attachment to the destination (Gyte & Phelps, 1989), which is called location proximity. This term is also used in the paper by Blöse et al. (2015), where the authors found that first-time visitors responded better to the social norms by participating more with pro-environmental behaviours, whereas repeat visitors responded less. The results of both studies are contradictory. However, as Gossling et al. (2019) conducted their study in the small touristic island of Gran Canaria, this makes this study, its design and results more relevant to the island of Aruba. Additionally, tourists coming from Nordic countries

were more likely to participate too because in those countries, there is more awareness over environmental matters (Strand, 2009) and in terms of hotel type the 4-star ones have more chances of yielding better results. This is due to the “resource intense lifestyles” (Gossling et al., 2019, p. 279) that people who can afford 5-star hotels tend to have and how “more financially restricted clientele” in 3-star hotels believe they have a right to the towels and linen due to what they have paid (Gossling et al., 2019). Also, there were observations that there are not only differences between hotels, but also within, as standard and superior rooms responded differently to the nudge (Gossling et al., 2019; Terrier & Marfaing, 2015). In this case, the authors explain it as guests located in superior rooms feeling more superior and therefore deviating from the norm because they wish to act differently to the rest due to higher status they feel (Lorenzi-Cioldi, 2009). Overall, it is highlighted how there are many factors to be mindful about and measure in order to identify additional variables that mediate the effect that messages have on tourists’ behaviour.

Lastly, not all studies show coherent results in terms of the effectiveness of social norms, as with the paper by Mair & Bergin-Seers (2010), which deviates from the previous ones. They tested different interventions, which included descriptive norms, and compared their effects to determine the best one to encourage towel reuse in motels in Australia. The difference that can already be noted is that the previous studies were conducted someplace else than Australia, as well as being in hotels rather than motels, which tend to have a lower standard in terms of cost and quality. The descriptive norm was among the nudges that had the highest level of towel reuse. Despite this, there is still a difference that was noted by the authors, which is that it didn’t play such a significant role as in Goldstein et al. (2008). This could be attributed to the explanation of Gossling et al.’s (2019) findings, which is that nationality and the type of hotel mediates the strength of the effect of the norm. In this case, a motel is even lower in standard

than a 3-star hotel which means that people would feel that the amount that was paid makes them “entitled to fresh towels every day” (Mair & Bergin-Seers, 2010, p. 265). Also, unlike other studies reviewed in this paper, Mair & Bergin-Seers (2010) commented that the reduced effect of the norm could be that reuse is becoming the norm and that habit plays an important role in this, which could be linked to the Australian context. The role of place and context would be something interesting for the authors to study as future research.

3. Methodology

3.1 Aruba - Case Characteristics

The challenges of tourism for the island of Aruba were discussed at the beginning of this paper, the main challenge being the potential surpassing of the carrying capacity of the island (Department of Economic Affairs, Commerce and Industry Aruba, 2019; SDG Aruba, 2017). As a result of having such a high number of visitors a lot of waste is produced. Tourists can for example contribute considerably to addressing the plastic waste problem. Disposing of waste safely or recycling is a big issue, one should only have a look at the landfill in Parkietenbos to realize that.

In terms of water, an increasing number of people also means a higher demand for water. The SDG Roadmap (2017) highlighted the need for water saving behaviour. Water in Aruba is produced by a desalination process that is highly energy intensive (SDG Roadmap, 2017) and involves depositing brine back into the ocean. This process is “currently unsustainable as fossil fuels are needed for freshwater production” (Easy & efficient desalination in Aruba: The solution to enjoy affordable clean water, n.d.). Moreover, “brine disposal damages reefs and ocean life” (World’s First Renewable Drinking Water, Sourced From the Sky and Sustainably Bottled, to Be Offered Across Aruba, 2021). Additionally, wastewater is another problem. From one of the interviews that I conducted I learnt that

there is currently one wastewater treatment facility in Bubali that processes wastewater off the majority of the hotels in that area, as well as residential houses. Due to the high amounts of wastewater produced, which is related to the unsustainable amount of visitors in the region, it is working at above its capacity. This means that water that is not adequately treated is deposited back into the ocean causing contamination.

Based upon the considerations above, the target behaviours for this study is towel reuse, aiming at indirect water saving, as well as reducing plastic waste, in the form of refillable water canteen use.

3.2 Field Experiment

Provincial norms were nearly consistently shown to be the most effective in the studies that were reviewed previously (Goldstein et al., 2008; Gossling et al. 2019; Reese et al., 2014). They used the specific room where the guests are staying as the reference group for the social norm, which are the guests' most immediate surroundings. As isolated nudges had a stronger effect than combined ones (Terrier & Marfaing, 2015), the message used by Goldstein et al. (2008) will be used in this study for 2 hotels in Aruba. This is because the authors conducted the experiment with various treatment groups and one of the conditions contained a provincial norm which was already isolated. Additionally, most of the studies used a similar format to convey the norm using a percentage figure, mainly 75% (Goldstein et al., 2008; Reese et al., 2014; Terrier & Marfaing, 2015), except in Gossling et al.'s (2019) study, where 82% was used. Therefore, the provincial norm format in the messages is coherent and will be used accordingly in the current study.

3.2.1 Participants

Hotels in Aruba were approached to participate in this study and two agreed to collaborate: Amsterdam Manor Beach Resort and Bucuti & Tara Beach Resort. Data will be

collected for a certain period of time and guests will not be aware of the field experiment taking place.

3.2.2 Intervention

The current in-room messages that both of the hotels have will be changed to reflect provincial social norms. The norm that will be included in the printed signs will be an adapted version from the message used in the study by Goldstein et al. (2008): "JOIN YOUR FELLOW GUESTS IN HELPING TO SAVE THE ENVIRONMENT. In a study conducted in Fall 2003, 75% of the guests who stayed in this room (#xxx) participated in our new resource savings program by using their towels more than once. You can join your fellow guests in this program to help save the environment by reusing your towels during your stay." (Goldstein et al., 2008, p. 476).

All the rooms in both hotels will be in the treatment condition, where the new adapted message will be used, and in the control condition for the month of March 2023, where the previous messages that hotels were using were in every room. The change after implementing provincial social norms will be measured between both conditions to determine whether the nudge had a significant effect on the targeted behaviours.

3.2.2.1 Amsterdam Manor Beach Resort

The original message (see Appendix A) that Amsterdam Manor Beach Resort had, asked guests to help with the hotel's aim to responsibly use water, energy and land, and is followed by instructions for keeping or replacing towels, as well as other methods to reduce water and energy use. However, the idea that guests should use less water by reusing towels is not made very clear. The sign will be adapted to reflect the provincial norm: "JOIN YOUR FELLOW GUESTS: Last year, 75% of the guests who stayed in this room participated in our new resource savings program by using their towels more than once. You can help conserve the environment by reusing your towels during your stay."

This is a modified version of the statement used in the study by Goldstein et al. (2008). The changes were minimal, to make the message more concise and less repetitive. The date 2003 was changed to be more recent, as the current study is in 2023. This message also reflects how reusing towels will help to conserve water and as such makes the purpose of the programme more salient.

Every hotel room will have a printed sign reflecting the previous norm, which will be within the existing layout that the hotel has for in-room signs (see Appendix B).

3.2.2.2 Bucuti & Tara Beach Resort

The original message (see Appendix C) that Bucuti & Tara Resort had, asked guests to help with the hotel's aim to preserve the environment by using the refillable water canteens that the hotel gifted them to discourage purchase of plastic bottles. Its purpose is to reduce plastic waste and use the water from the tap that is safe to drink. The sign will be adapted to reflect the provincial norm: "JOIN YOUR FELLOW GUESTS: Last year, 75% of the guests who stayed in this room used the refillable water canteens, a gift for you. You can help conserve the environment by not using plastic bottles, which can't be recycled on Aruba. Thank you." This is a modified version of the statement used in the study by Goldstein et al. (2008). As with the previously adapted message for Amsterdam Manor Beach Resort, minor changes were made for less repetition and for the message to show a more recent time period. This message also reflects the different target behaviour for this hotel, which is to reduce plastic waste by encouraging the use of reusable water canteens that are gifted to the guests by the hotel. Additional aspects were included in the message that were present in the original version, which are the concept of a gift and the fact that plastic can't be recycled on Aruba. These are necessary to provide context for the purpose of the hotels programme with the refillable water canteens for the island's environment.

Every hotel room will have a printed sign reflecting the previous norm, which will be within the existing layout that the hotel has for in-room signs (see Appendix B).

3.2.3 Measurement

3.2.3.1 Amsterdam Beach Manor Resort

The change in towel reuse after the implementation of the nudge will be measured by comparing the change in the amount of water used for laundry. The baseline data, that will be used as the control condition for comparison, is daily data for the month of March. The same type of data will be obtained from the hotel for the period of the intervention. Additional variables will be used in the analysis of the results, such as the occupancy data of the hotel in the control and treatment periods. This is because if the hotel is fuller there will be more people using towels, and this will affect the number of towels, and laundry water, used. There is also data on how many are returning guests, to assess whether there is a difference caused by this, as explained in the literature review as location proximity (Blöse et al., 2015). The items that are used in the laundry of the hotel were obtained, which includes bath, kitchen and beach towels, as well as linen.

3.2.3.2 Bucuti & Tara Beach Resort

The change in the use of water canteens by guests, after the implementation of the nudge, will be measured by the amount of water canteens that are replaced, which guests have taken, and recycled, which guests haven't used. The baseline collected is an average from the month before the intervention, which will be compared to the average data for the period the nudge is in place. Like for the previous hotel, data on occupancy will be collected as well as on the proportion of returning guests.

4. Results

The messaging interventions have not yet been designed or implemented due to time constraints.

For the results, please see Appendix B.

5. Discussion and Conclusion

Tourism is hedonic in nature, as it has the connotation of being pleasurable, relaxing and leaving all of your troubles and obligations home. This can limit the effectiveness of interventions (Gossling et al., 2019), because tourists are less engaged in green initiatives. Also, small changes in one hotel do not solve the sustainability threats from an island-wide perspective (Gossling et al., 2019). This means that even though one or several studies are successful, all establishments should implement interventions for there to be a notable effect on water use or plastic waste.

For the discussion of the results, please see the appendix B.

5.1 Limitations

Specific to this study, time was the limitation, and therefore the study is incomplete. For this reason, a QR is provided in order to be able to access the complete information and conclusions when the research is finished. Also, the scope is limited to the target behaviours of towel reuse, the use of refillable water canteens and reduction of (plastic) waste. These were chosen because these behaviours can be measured more easily, and the collaborating hotels already track laundry water, plastic waste and the use of refillable water canteens.

5.2 Recommendations

The following statements were collected from people I interviewed in the process of conducting this research in order to raise important points about interventions on tourist behaviour, where firstly, the importance of waste awareness and management is highlighted. This also includes outside the hotel:

“In my opinion, the biggest impact a tourist can have during their stay is their waste. It is important to educate them on

the resort’s waste management strategy, how they can reduce their waste, where they can safely dispose of their waste, and how to respect the local environment by not disposing their waste in nature” – Quality Assurance Manager

Additionally, other points are raised that go beyond the behaviours that are targeted in this paper but do have a major impact on the environment (Mair & Bergin-Seers, 2010).

A second recommendation is that behavioural change can and should be targeted in the airport or by the airlines that people use to travel to Aruba. “The airport is the most important starting point as it is the first contact with the island” - Ing. Jareth Vermeulen.

Ewald Biemans, owner and CEO of Bucuti & Tara Beach Resort, highlighted the importance of raising awareness “of the impact travel & tourism have on a destination and on the environment [...] in an educational way”, as “not everyone is aware of the damage caused by emissions and that there are options to diminish the footprint a traveller can take by staying at genuinely certified or preferably carbon neutral hotels and making use of EVs and natural modes of transportation like sailing, walking and hiking instead of using gasoline engine vehicles and motor boats and cars”, as well as “avoid cruise ships as these are the biggest polluters by emitting double or triple the emissions of a tourism destination of the same size”. Additionally, Ewald Biemans also mentioned that “on the social part, they should volunteer for causes and charities, buy local products and local arts and crafts, consume local specialities, and enjoy local entertainment”.

This is linked to the term economic leakages, which in the Caribbean are between 70-90% (Armstrong & Read, 2020). This means that many of the expenditure from tourists in the destination does not stay within Aruba, because the places where these purchases are made end up in foreign hands.

Therefore, by making more locally-sourced purchases, as Biemans mentions, the local community will have the opportunity to benefit more from the opportunities that tourism is supposed to offer in a destination.

5.3 Conclusion

For the complete conclusion after the experiment is conducted, please see appendix B.

7. Acknowledgements

I would like to thank Eric Mijts and Jocelyn Ballantyne for the organization and running of the program. It was awesome and a great opportunity to develop our independent research skills and to learn about sustainability in SIS, as I wouldn't have been able to learn about this if I had finished my degree at UCU. Also, when I made the decision to return home earlier, I felt very supported by them and everyone, and I greatly appreciate that. I also wanted to thank Jade Maxwell & Amsterdam Manor, Ewald and Cresi Biemans & Tara & Bucuti Resort for collaborating with me in my research, as well as Jareth Vermeulen and the ATA for their cooperation in the interviews. My research would not have been possible without their help and input. Also thanks to my supervisor Kim Zwitserloot at UCU for helping and guiding me through my research process, as I was quite lost at times, and the students and staff at UA for being so welcoming and for creating very nice environment to study at. Lastly, I want to thank the friends I made there during the program, because without them it wouldn't have been the same and as fun, and my family back home for always having my back and supporting me when I was having a hard time.

Appendix A

We are a Green resort!

We take responsibility for the use of our water, energy, and land,
and ask that you consider helping us.

Please decide for yourself:

- A towel on the rack means "I'll use it again".
- A towel on the floor means "Please exchange".

Beach towels:

- Beach towels are placed in your room and refreshed daily during service.
- A towel on the rack means "I'll use it again".
- A towel on the floor means "Please exchange".
- For fresh towels prior to room service, please contact the front desk at ext. 0.
- One of our staff members will deliver this to your room in exchange of the used towel(s).

You can also protect and conserve this vital resource by:

- Turning off the faucet while brushing your teeth or shaving, and turning the water off while lathering.
- Being sure faucets are turned off completely.
- Not using the toilet as a trash receptacle.
- Report leaky faucets or toilets.

More ways you can help:

- Turn off the lights, fan and TV when you leave your hotel room.





Amsterdam Manor
BEACH RESORT ARUBA



EARTHCHECK

Appendix B



The incomplete sections of this paper will be completed and posted in the document attached to the following QR around the 1st of July 2023. If you have any questions, don't hesitate to contact me through my personal email: noemiperezkluin@gmail.com.

Appendix C



References

- Allen, C. T. (1982). Self-perception based strategies for stimulating energy conservation. *J. Consumer Res.* 8:381. doi: 10.1086/208878
- Armstrong, H. W. & Read, R. A. (2020). Tourism and Sustainable Growth in Small (Island) Economies. In J. L. Roberts et al. (Eds.), *Shaping the Future of Small Islands* (pp. 93-108). Palgrave Macmillan. https://doi.org/10.1007/978-981-15-4883-3_5
- Aruba Tourism Authority. (2019). Sustainable Tourism in Aruba. Retrieved from <https://www.aruba.com/us/sustainable-tourism-in-aruba>
- Blose, J. E., Mack, R. W., & Pitts, R. E. (2015). The influence of message framing on hotel guests' linen-reuse intentions. *Cornell Hospitality Quarterly*, 56(2), 145-154.
- Brekke, Kjell Arne, Snorre Kverndokk and Karine Nyborg (2003). An economic model of moral motivation. *Journal of Public Economics* 87, 1967–1983.
- Bryan, C. J., Walton, G. M., Rogers, T., and Dweck, C. S. (2011). Motivating voter turnout by invoking the self. *Proc. Natl. Acad. Sci. U.S.A.* 108, 12653–12656. doi: 10.1073/pnas.1103343108
- Central Bureau of Statistics. (2021). *Tourism in Aruba 2009-2021: Table 1.3 Total number of visitors, 2009-2021.* <https://cbs.aw/wp/index.php/2021/12/15/tourism-in-aruba-2018/>
- Cialdini, R. B., & Goldstein, N. J. (2004). Social influence: compliance and conformity. *Annual Review of Psychology*, 55(1), 591-621.
- Cvelbar, L. K., Grün, B., & Dolnicar, S. (2017). Which hotel guest segments reuse towels? Selling sustainable tourism services through target marketing. *Journal of Sustainable Tourism*, 25(7), 921–934. <https://doi.org/10.1080/09669582.2016.1206553>.
- Department of Economic Affairs, Commerce and Industry Aruba. (2019). *Sustainable Tourism Program 6 Report.* <https://www.deaci.aw/wp-content/uploads/2020/11/FINAL-Report-Sustainable-Tourism.pdf>
- Dolnicar, S. (2020). Designing for more environmentally friendly tourism. *Annals of Tourism Research*, 84, 102933.
- Dolnicar, S., & Ring, A. (2014). Tourism marketing research: Past, present and future. *Annals of Tourism Research*, 47, 31-47.
- *Easy & efficient desalination in Aruba: The solution to enjoy affordable clean water.* (n.d.). Elemental Water Makers. <https://www.elementalwatermakers.com/desalination-aruba/>
- Foley, A. M., Moncada, S., Mycoo, M., Nunn, P., Tandrayen-Ragoobur, V., & Evans, C. (2022). Small Island Developing States in a post-pandemic world: Challenges and opportunities for climate action. *Wiley Interdisciplinary Reviews: Climate Change*, 13(3), e769. <https://doi.org/10.1002/wcc.769>
- Franssens, S., Botchway, E., De Swart, W., & Dewitte, S. (2021). Nudging commuters to increase public transport use: a field experiment in Rotterdam. *Frontiers in psychology*, 12, 633865.
- Garner, Randy. 2005. "Post-It R Note Persuasion: A Sticky Influence." *Journal of Consumer Psychology* 15 (3):230–237.
- Gillingham, K., & Tsvetanov, T. (2018). Nudging energy efficiency audits: Evidence from a field experiment. *Journal of Environmental Economics and Management*, 90, 303-316.
- Goldstein, N. J., Cialdini, R. B., & Griskevicius, V. (2008). A room with a viewpoint: Using social norms to motivate environmental conservation in hotels. *Journal of Consumer Research*, 35, 472–482.
- Gössling, S., Araña, J. E., & Aguiar-Quintana, J. T. (2019). Towel reuse in hotels: Importance of normative appeal designs. *Tourism Management*, 70, 273-283.
- Gyte, D. M., & Phelps, A. (1989). Patterns of destination repeat business: British tourists in Mallorca, Spain. *Journal of Travel Research*, 28(1), 24–28.

- Index Mundi. (n.d.). *Aruba Waste and recycling*. https://www.indexmundi.com/aruba/waste_and_recycling.html
- Iyer, Easwar S. and Rajiv K. Kashyap (2011). Consumer recycling: Role of incentives, information, and social class. *Journal of Consumer Behaviour* 6, 32–47.
- Jenkins, Robin R., Salvador A. Martinez, Karen Palmer and Michael J. Podolsky (2003). The determinants of household recycling: a material-specific analysis of recycling program features and unit pricing. *Journal of Environmental Economics and Management* 45, 294–318.
- Kahneman, D. (2003). Maps of bounded rationality: Psychology for behavioral economics. *American economic review*, 93(5), 1449-1475.
- Karakaş, G. (2021). Factors affecting women's waste separation behaviour in Turkey. *CES Working Papers*, 13(2), 181-196.
- Karlson, R., & Andersen, A. (2019). Recommendations with a nudge. *Technologies*, 7(2), 45.
- Kraut, R. E. (1973). Effects of social labeling on giving to charity. *J. Exp. Soc. Psychol.* 9, 551–562. doi: 10.1016/0022-1031(73)90037-1
- Mair, J., & Bergin-Seers, S. (2010). The effect of interventions on the environmental behaviour of Australian motel guests. *Tourism and Hospitality Research*, 10(4), 255-268.
- Milford, A. B., Øvrum, A., & Helgesen, H. (2015). Nudges to increase recycling and reduce waste.
- Lorenzi-Cioldi, F. (2009). *Dominants et domines. Les identites des collections et des agregats*. Grenoble: Presses Universitaires.
- Reese, G., Loew, K., & Steffgen, G. (2014). A towel less: Social norms enhance pro-environmental behavior in hotels. *The Journal of Social Psychology*, 154(2), 97-100.
- Reisch, L. A., & Zhao, M. (2017). Behavioural economics, consumer behaviour and consumer policy: state of the art. *Behavioural Public Policy*, 1(2), 190-206.
- Reschovsky, James D and and Sarah E. Stone (1994). Market Incentives to Encourage Household Waste Recycling: Paying for What You Throw Away. *Journal of Policy Analysis and Management*, 13(1), 120-139
- Ruokamo, E., Meriläinen, T., Karhinen, S., Rähkä, J., Suur-Uski, P., Timonen, L., & Svento, R. (2022). The effect of information nudges on energy saving: Observations from a randomized field experiment in Finland. *Energy Policy*, 161, 112731.
- Tafjel L. 1979. "Individuals and Groups in Social Psychology." *British Journal of Social and Clinical Psychology* 18:183–90.
- Terrier, L., & Marfaing, B. (2015). Using social norms and commitment to promote pro-environmental behavior among hotel guests. *Journal of Environmental Psychology*, 44, 10-15.
- Thaler, R. H. (2000). From homo economicus to homo sapiens. *Journal of Economic Perspectives*, 14(1), 133-141
- Thaler, R. H. & Sunstein, C. R. (2008). *Nudge: Improving decisions about health, wealth, and happiness*. New Haven, CT: Yale University Press
- The 17 Goals. (n.d.). Retrieved from <https://sdgs.un.org/goals>
- Tversky, A., & Kahneman, D. (1979). Prospect theory: An analysis of decision under risk. *Econometrica*, 47(2), 263-291.
- Tybout, A. M., & Yalch, R. F. (1980). The effect of experience: a matter of salience?. *Journal of Consumer Research*, 6(4), 406-413.
- Schultz, P. W., Nolan, J. M., Cialdini, R. B., Goldstein, N. J., and Griskevicius, V. (2007). The constructive, destructive, and reconstructive power of social norms. *Psychol. Sci.* 18, 429–434. doi: 10.1111/j.1467-9280.2007.01917.x
- SDG Aruba. (2017). *A Roadmap for SDG Implementation in Aruba*. https://sdgaruba.com/pages/wp-content/uploads/2022/07/2018-Aruba-DRAFT_SDG_Roadmap-FINAL-DRAFT-versie-2-dec-2017-26_6_18.pdf

- Sherif, Muzafer. 1937. “An Experimental Approach to the Study of Attitudes.” *Sociometry* 1:90–98.
- Stanne, May Beth, David W. Johnson, and Roger T. Johnson. 1993. Does competition enhance or inhibit motor performance: A meta-analysis. *Psychological Bulletin* 125 (1): 133-54.
- Strand, R. (2009). Corporate responsibility in Scandinavian supply chains. *Journal of Business Ethics*, 85, 179–185
- Sustainable Travel International. (2019). *Study on Tourism Carrying Capacity for the island of Aruba*. Unpublished draft.
- Wee, S. C., Choong, W. W., & Low, S. T. (2021). Can “Nudging” Play a Role to Promote Pro-Environmental Behaviour?. *Environmental Challenges*, 5, 100364.
- Weßel, G., Altendorf, E., Schwalm, M., Canpolat, Y., Burghardt, C., Flemisch, F., 2019. Self-determined nudging: a system concept for human-machine interaction. *Cognition, Technology & Work* 21 (4), 621–630
- *World’s First Renewable Drinking Water, Sourced From the Sky and Sustainably Bottled, to Be Offered Across Aruba*. (2021, October 19). Business Wire. <https://www.businesswire.com/news/home/20211019005502/en/World%E2%80%99s-First-Renewable-Drinking-Water-Sourced-From-the-Sky-and-Sustainably-Bottled-to-Be-Offered-Across-Aruba>



Hanna Siwek, University College Utrecht

I even free dived at night and saw a shark!

Aruba has taught me that a failure is never really a failure unless I let it drag me down. And despite a seeming catastrophe, I can bloom and flourish. Coming to Aruba I had a very simple plan to follow the UA course and do research on Benzene degrading bacteria in the soil in the vicinity of the landfill. I thought I would get to know the island life, spend some time in the ocean and watch a bunch of sunsets at the beach. I would have never thought that I would have to abandon my project, but also become a crew member of a sailing boat – find a job that gave me a family in Aruba, and join a Coral DNA Connectivity research team. But lets start at the beginning.

The seeming catastrophe was growing with ticking time as my equipment delivery was “on its way.” Fast forward, the “on its way” lasted for three months. After having passed the halfway mark of my time in Aruba, I decided that it was going to be my conscious choice to have a great and

productive time despite the research obstacles. I had to make an executive decision about accepting that my original project was not going to go forward. Luckily, I have been able to rebrand my thesis, I got accepted to a research team under the eye of Violeta Lopez who I have been reading about since the beginning of researching Aruba. I had a chance to educate myself on coral connectivity and seascape genetics while continuously working on the theoretical design of my benzene degraders work for potential future UAUCU generations. I found the balance between work and life through embracing the sailing life and all the adventures that followed. I realized how much fun people can have just enjoying their surroundings and how initiative and creativity in spending ones time makes all the difference in someone’s experience. I even free dived at night and saw a shark! Aruba to me is the place of unexpected opportunities, crazy connections, and genuine impact (both in terms of research and personal interactions).

I would like to thank Anthony for accepting me into his crew, Arianne, Ivan, and Alex for accepting me into their family, Eric for helping me accept the reality and for being my continuous support. I would like to thank Violeta Lopez-Marquez and Filip Volckaert for their faith in my contribution to the Coral DNA Connectivity work, and Ralf for introducing me to Eugen Seibold research vessel

from the Max Plank Institute for Chemistry which I will potentially be joining for an expedition later this summer in Panama. Finally, I would like to thank the whole team of UAUCU for being inspiring and great researchers, and specifically, thank you Jasmine for being a great partner in crime roommate.



The Double-edged Sword – Benzene Degrading Bacteria in the Parkietenbos Landfill

Hanna Siwek

Abstract:

Aruba, a small island state in the Caribbean, faces unique struggles in dealing with its waste, responsibly and sustainably. There is no universal system of recycling waste, and the level of waste disposed on the landfill has significantly exceeded safe, initially established limits of capacity. The overflowing landfill often leads to air pollution through the burning of trash, and soil and groundwater contamination through leachate. This paper designs a study that proposes an examination of the pollution of soil by a toxic compound, benzene, through investigating the presence and the scale of growth of benzene-degrading bacteria in the soil in the vicinity of the landfill. The research proposes a comprehensive evaluation of the harmful impact that benzene has on the ecosystem and people as well as description of the role of benzene degraders in breaking down said pollution. This bioremediating process can be seen as a double-edged sword which can identify the contamination in case of enhanced growth of benzene degraders, while simultaneously proposing a potential solution that the microbiome of the soil can offer when managed properly. The paper offers a thorough discussion of adequate sampling location, research methodology, as well as potential results and their implications. Ultimately, the research highlights the urgency of investigating the benzene pollution originating from the landfill in Aruba.

Introduction:

Waste management as an enhanced challenge in the small island state of Aruba

Ideal sustainable development aims to achieve progress without exploiting or sacrificing any other aspect of life. According to the World Health Organization, sustainable development involves making decisions that do not compromise environmental, social, and personal health in the future, while still providing benefits today (WHO, n.d.). However, in reality, development often prioritizes economic progress at the expense of other factors. A clear example of this is the issue of excessive consumption and the consequential generation of waste. This issue, present all over the globe, is very prevalent in small island states such as Aruba. The island generates an estimated 140 kilotons of waste annually, which is managed by Serlimar and Ecotech companies (The Waste Management Virtual Platform, n.d.). Despite the companies claims of being sustainable and environmentally-friendly, only 1% of plastic waste is currently being recycled. There are numerous efforts of NGOs, such as the Plastic Beach Party which aim to democratize information and tools that enable citizens to be active participants in sustainable waste management and encourages them to play a role in the transition to a sustainable society (Community Guide Aruba, n.d.). This can be achieved through initiatives such as organized

cleanups, and collection and recycling of plastic waste. The government and other stakeholders have made attempts to transition to sustainable waste management practices, as evidenced by the Project Aruba initiative (Project Aruba, n.d.). Nevertheless, due to the overwhelming lack of a uniform solution to the problem of plastic and other waste, the un-recycled trash is being dumped in a landfill that is already overflowing. This poses a significant threat to both the ecosystem and the people living in its vicinity. Waste management in an isolated country such as Aruba faces unique challenges due to the relatively small-scale waste treatment facilities on the island, as well as its geographical isolation from other waste management facilities.

Landfill, Pollution, Community, and Bacteria

The inadequate management of the landfill in Aruba is a significant problem, as it has led to environmental pollution in the surrounding area. The pollution can have harmful effects on the ecosystem, groundwater, soil, and humans who interact with it (Anderson, 2003). The ecosystem is heavily impacted as seen, for example, through the destruction of the Mangrove forest in the West Parkietenbos mangrove forest which provides habitat for many species of birds, fish, and mammals (Loosveld, 2018). The investigation of the impact on the people has been carried out by Laura Mathieu (2022) through interviewing the Parkietenbos community. This research highlighted the many health concerns that the community, living in the neighborhood adjacent to the landfill, faces. Amongst others, the issues indicated were high cancer rates, health issues noticed to be happening in children at similar times, as well as allergies, asthma, and migraines. Given the health issues being linked to increased pollution due to potential hazardous leakage from the landfill, urgent action is required to collect information and determine the scale of the pollution and intervention strategies. Nevertheless, the community of Parkietenbos notices the lack of intervention and claims that “the government washes its hands in innocence because

there is no hard data that people get sick under the toxic gases” (Redactie, 2021). Furthermore, there has been no government initiated study conducted to assess the health of the residents (Henriquez, 2023) despite the increased presence of chronic allergies, skin problems, asthma and other lung diseases, heart problems, and cancer.

It is essential to recognize that the impact of the sub-optimally managed landfill is not limited to its immediate surroundings but also extends to the wider area and therefore is of concern to the population of the island (Afolabi et al., 2022). The landfill has officially been closed in December 2022. Currently the waste processing companies continue to collect waste with a promise that “there will be more options (for recycling) in the near future” (Overheid, 2022). The Government of Aruba proposed a new initiative that will rehabilitate the dumpsite into a park for solar energy (Overheid, 2022). In the meantime, there is no concrete plan for investigating the contamination of this location. It is crucial to investigate the location and its potentially harmful qualities before committing to a new initiative that involves workers and stakeholders directly interacting with that environment.

There are multiple ways of assessing the health of the environment, one of them being the evaluation of the presence of bacteria that use pollutants as their carbon source (Kalwasińska & Burkowska, 2013). Bacteria such as benzene degraders serve as an effective indicator that suggests evolutionary pressure present in the soil around municipal landfill sites that favors microorganisms that can thrive in environments polluted by benzene. Research on such bacteria found in unmanaged landfills is an essential starting point for discussions about sustainable development and preventing further contamination.

The hazardous impact of the pollution threatens biodiversity, the health of the land and the community, and represents unsustainable development on the island. The

study of microbial diversity in soil has relevance in several academic fields including microbiology, molecular biology, bioremediation, community-engaged research, and sustainable development. Despite the significance of this topic, there has been little research conducted in Aruba on microbial biodiversity in soil. Through researching benzene degrading bacteria in soil, this study aims to investigate the impact of the landfill on the soil microbiome, and hence the wildlife and people that come to contact with it. This research aims to develop the methodology for identifying and measuring pollution by benzene in soil by studying the benzene degrading bacteria living in it. Ultimately, it aims at designing steps to determine whether the presence and scale of growth of benzene degrading bacteria indicate high levels of pollution of soil by benzene originating from the Parkietenbos landfill.

Bioremediation of benzene polluted soil:

Bioremediation and Landfills

Bioremediation is a process that uses microorganisms such as bacteria, fungi, and plants to break down and eliminate contaminants from soil, water, and air (Singh et al., 2014). This process can be investigated through microbial counts, soil respiration, soil biomass, and several enzyme activity tests (Margesin et al., 2000). Bioremediation and the associated methods have been gaining popularity as a sustainable and cost-effective alternative to traditional remediation methods such as excavation and incineration (Abu Hamed et al., 2004).

In the vicinity of polluted landfills, bioremediation can be a critical tool to mitigate the negative environmental and health impacts associated with hazardous waste. Landfills are known to release a wide range of contaminants such as heavy metals, pesticides, volatile organic compounds (VOCs), and polycyclic aromatic hydrocarbons (PAHs) into the surrounding environment (Sibeko et al., 2020).

This is a leading cause of soil and groundwater pollution, air contamination, and increased risk of cancer and other health problems for nearby residents (Hou et al., 2023).

Bioremediation can target specific contaminants present in landfills and convert them into less harmful substances, thus reducing the overall toxicity of the waste. Studies have shown that bacteria can degrade VOCs into compounds such as phenol and catechol (Vogt et al., 2011) which, although toxic themselves, are further broken down to serve as a carbon source for bacteria and become harmless (Flanders, 2021). One of the prominent examples of VOCs, which is detrimental to health but can be bio-degraded, is benzene.

Benzene

Benzene is a toxic chemical compound that is commonly found in landfills. According to the Agency for Toxic Substances and Disease Registry (ATSDR, n.d.), it is a colorless, highly flammable liquid that has a sweet odor and is commonly used in the production of plastics, synthetic fibers, and other industrial products. Benzene is also a common component of gasoline and other petroleum-based products. In landfills, benzene is released from the decomposition of organic matter, plastics, rubber, and other petrochemical-based materials. If not managed properly, it can contaminate the surrounding environment through leachate, due to the high solubility of this compound (Riediker et al., 2000).

Benzene is a known carcinogen and has been linked to an increased risk of leukemia, lymphoma, and other cancers. The US Environmental Protection Agency has classified benzene as a Group A human carcinogen (EPA, n.d.). Additionally, this substance is mutagenic, genotoxic, and neurotoxic to humans (Chaudhary et al., 2023). Exposure to benzene can occur through inhalation of contaminated air, ingestion of contaminated food or water, or skin contact

with contaminated soil or water. Benzene can also cause a variety of non-cancerous health effects, such as dizziness, headaches, and nausea. The harmful effects of benzene on human health have led to increased regulations on its use and disposal. The persistence of benzene in the environment due to leachate from landfills makes it a high priority concern.

Benzene Degraders

Benzene-degrading bacteria are types of microorganisms that have the ability to break down benzene into less harmful substances. This process is called biodegradation. The biodegradation of benzene by bacteria is an important process that naturally occurs in healthy microbiomes of soil and serves attenuation of benzene in soil and groundwater. It is also a strategy for bioremediation of contaminated sites, as it can enhance the breakdown of benzene and reduce the risk of human exposure to this harmful chemical. Benzene degrading bacteria metabolize benzene as a source of carbon for cell respiration. They can do that in anaerobic and aerobic conditions (Jindrová et al., 2002; Vogt et al., 2011). The effectiveness of benzene biodegradation by bacteria depends on several factors, such as the availability of nutrients and oxygen, the presence of other contaminants, and the diversity and activity of the bacterial community.

The biodegradation of benzene is typically initiated by the oxidation of benzene to phenol, which is then further oxidized to catechol (Vogt et al., 2011). Catechol can then be metabolized through different pathways (Figure 1), depending on the specific bacterial species and environmental conditions. Some benzene-degrading bacteria can use catechol as a carbon source and energy substrate through the ortho-cleavage pathway, which breaks down catechol into smaller molecules such as acetaldehyde and pyruvate (Kim et al., 2002). Other bacterial species use the meta-cleavage pathway, which breaks down catechol into molecules such as maleylacetate and fumarate (Mars et

al., 1997). These molecules can be further metabolized into intermediates of the tricarboxylic acid (TCA) cycle, which is an important metabolic pathway for energy production in many organisms.

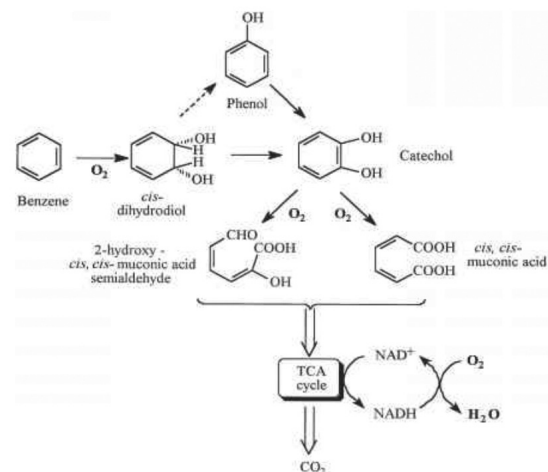

Figure 1. The metabolic pathways of benzene biodegradation under aerobic conditions result in the breakdown of benzene into phenol, catechol, and ultimately CO₂, following the citric acid cycle during cellular respiration. (Flanders, 2021)

Evidently, the presence of benzene in soil is an environmental and health hazard, but bioremediation through benzene degrading bacteria offers a potential solution to mediate the harmful effects. The method of bioremediation has limitations, however. In a study conducted by Singh et al. (2014), it was shown that only up to a specific concentration of the compound was the full biodegradation of benzene possible. This was shown by the study on bioremediation of benzene using cow dung microflora in the paper Microorganism as a tool of bioremediation technology for cleaning environment: A review by Singh et al. (2014).

The bioremediation of benzene was achieved from 67.5% to 100% at initial concentrations but when subject to increasing, at higher concentrations, benzene was found to be inhibitory to bacterial degradation. This shows that some concentrations of benzene can be broken down by degraders, but it is possible to exceed this level and transition to an environment with such high concentration of benzene that it disables microbial interactions. This stage is incredibly dangerous for the ecosystem and everyone interacting with it. As a toxic VOC, benzene can poison the environment to the point of no return that cannot be combated by simple, natural bioremediation.

The investigation of the presence, type, and scale of benzene degrader colonies in the soil can shed light on the scale of pollution and the potential for bioremediation. Benzene degrading bacteria serve as a great initial investigation of benzene pollution due to the fact that the microbial community composition changes considerably and rapidly based on the presence and type of pollution (D'Ugo et al., 2021). As indicated previously, benzene degrading bacteria are an integral part of a soil's microbiome due to their ability to break down pollution. Their presence is a sign of a functional ecosystem. However, excessive growth and quantity of benzene degraders can indicate higher levels of pollution due to enhanced evolutionary pressure for using benzene as the carbon source. The absolute lack of benzene degrading bacteria in the vicinity of the landfill might be a sign of the pollution having exceeded the limit that the degraders can function in.

Overall, benzene-degrading bacteria play a crucial role in the natural and engineered remediation of benzene-contaminated environments, and their metabolic pathways can provide insights into the biodegradation of other aromatic compounds as well. Benzene is a harmful chemical that can be released from landfills through the decomposition of petrochemical-based materials and the toxic effects of benzene on human health make it a

significant environmental concern that requires careful monitoring and management.

Research methodology:

Soil sampling location

Selecting appropriate sampling sites is crucial for evaluating the impact of landfills on soil health and microbial diversity. As noted by Mallarino (2001), "soil sampling is one of the most significant sources of error in soil testing due to the spatial variation of nutrients within fields." This conclusion can be extended to the spatial variation of microbes highlighting that adequate choice of sampling locations is crucial for representative results. As such, the sampling sites must be chosen carefully in consultation with local experts and the community of Parkietenbos. Following a consultation with Melissa De Veer, and a field evaluation trip with the input of a student of the Academic Foundation at the University of Aruba, Lynette Genadry, the sampling site has been established. It was determined at the water channel which collects rainwater during weather events, but most of the year is dry.

The water channels play a specific role in connecting fresh and salty water creating a mixing zone that is known to have distinct microbial communities from the separate zones (Chen et al., 2020). In Aruba, the groundwater is qualified as brackish (Sambeek et al., 2000), which suggests that examination of the benzene degraders in the mixing zone between slightly saline groundwater, fresh rainwater, and ocean water can be an adequate representation of the general biodiversity of the microbial ecosystem on the island. The presence of groundwater in Aruba is very scarce, yet groundwater and rainfall events play a crucial role in shifting the content of microbial communities (Zeglin et al., 2013). Therefore, the water channel is a location that has the potential to show rapid response to the changes in the environment, for instance, due to leachate, making it an

optimal area for research. The landfill is downstream from the majority of the sampling points in the channel. This means that the potential leachate does not directly travel to the sampling locations, nevertheless, it can penetrate the soil and be transferred to the environment of the water channel. The location of the landfill and the sampling area is seen in Figure 2, and the satellite image of the area of the landfill and the mouth of the water channel is seen in Figure 3.



Figure 2: The map of Aruba with an area, indicated in red, of the location of the landfill and the area of sampling (Aruba, n.d.)



Figure 3: Satellite image of the area of the landfill and the mouth of the water channel passing by the Parkietenbos Paintball Field and flowing into the ocean at the most eastern side of the landfill (Landfill Perkietenbos, n.d.)

The sampling location of the water channel has been established as the most accessible and representative location due to numerous factors. The most important being many safe points of entrance (as it is located directly in the vicinity of the houses of the local community), passing directly next to the side of the landfill, and limited vegetation which gives easy access to the soil. This area is preferential over another candidate, the mangrove forest on the opposite side of the landfill, due to more consistent accessibility points, little impact that the sampling procedure might have on the flora and fauna of the area, and closer proximity to the houses of the inhabitants.

Specific sampling points have been determined moving away from the landfill along the water channel. The

sampling locations are chosen using the Zone Sampling method (Mallarino, 2001) which involves comparing different zones in a radial pattern expanding outwards, away from the potential source of pollution. This approach enables the investigation of the extent to which the landfill might impact the microbiome of the soil considering increasing distance. The distribution of the points is varied and unequal due to the accessibility of different fragments of the water channel. Ideally, there would be more sampling points and they would be equally spaced out but in reality, the geography of the location does not enable entry to many sampling points. Due to this limitation, it is necessary to acknowledge the unequal spatial distribution. However, the direct connection of the water channel of the landfill and the uninterrupted continuity of the channel should result in a reliable outcome. The exact sampling locations are presented in Figure 4. Coordinates of the sampling location:

1. 12.488130,-70.002321
Most south end of the Parkietenbos Paintball Field
2. 12.489386,-70.001526
Opposite, north end of the Parkietenbos Paintball Field
3. 12.4952056, -69.9992200
Entrance nearby Jo-Ann Bar & Restaurant
4. 12.4996062, -69.9971235
Location between two bridges across the highway

Figure 4: The map of the area of sampling with 4 distinct sampling locations indicated by a red cross and described by a number (Aruba, n.d.)

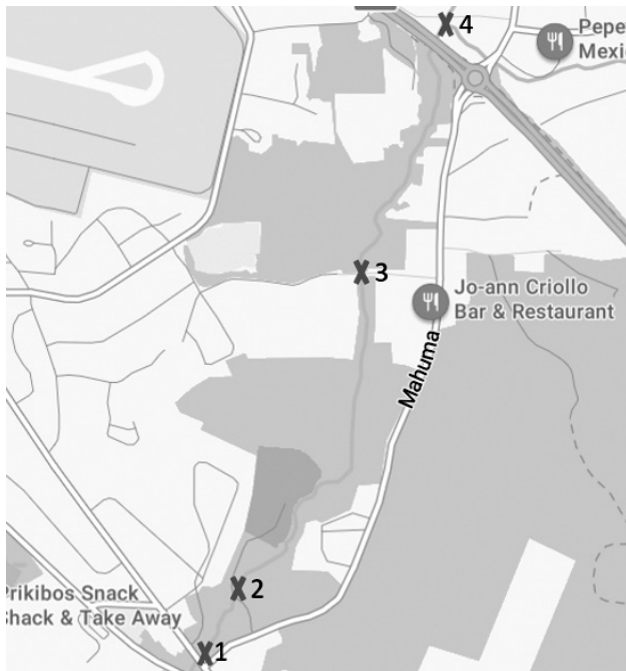

Each sampling point has specific advantages that make them relevant to the research, specifically considering the impact of the pollutants on the local population. Sampling locations one and two are very close to the Parkietenbos Paintball Field which are commonly interacted with by both the local inhabitants, specifically the staff of the park, and by people from all over the island, both Arubans and visitors (VY, n.d.). Schools, such as Schakel College, organize trips for students to the paintball field exposing the students and the teaching staff to that environment. Furthermore, apart from organized trips and individual visits to the field, there are many events such as birthday celebrations and parties that take place in the Parkietenbos Paintball Field (VY, n.d.). Moreover, the field is not only appealing to paintball fans, but also for other activities and organized sports events such as the Airsoft Speed QB (297 Sports, n.d.). Undoubtedly, this area of the paintball field is an often interacted with and popular area which increases the urgency of investigating the specific pollution by benzene in that location.

The third and fourth sampling locations extend further from the coast into the mainland. They are both very close to inhabited buildings and restaurants. The sampling location number three is located directly between houses, next to a restaurant called Jo-Ann Bar and Restaurant, and directly

connected to the roads that connect the Parkietenbos neighborhood with the highway. Point number four is the furthest away from the landfill and is surrounded by the highway and two roads connected to the highway, but there are numerous housing agglomerations and a taco restaurant – Tacos Pepe Nacho. Both locations, although not in the direct vicinity, can experience the effects of leachate and can be compared with sampling points in the direct vicinity of the source.



Figure 5: Photo showing the dry water channel at the entrance to the sampling location number 3

Finally, the fifth sampling point not included on the map, is the control site. It serves the role of comparison of the sampling sites one to four and the identified benzene degraders on those sites, to a potentially less contaminated soil located far away from the source of potential benzene pollution. The location of the control sampling should be chosen in a point situated far from the landfill but in a comparable environment. A reliable control site is in the neighborhood of Barcadera, at the mouth of a similar size water channel at coordinates 12.480512,-69.985492.

Soil sampling

The soil samples are collected from 5 locations, with each location resulting in two sets of samples depending on the depth. According to the study by Breza-Boruta et al. (2016) the soil samples are collected with an Egner stick (or another soil sampler) from two depths, one between 0–20cm and the second at a depth of 20–40 cm. Each soil sample is a mixture of five sub-samples. These sub-samples of 5 grams are collected from separate and randomly chosen locations within the selected area of 5 × 5 m. The resulting 25 grams of soil samples from every location and depth are stored in sterile plastic bags and kept at 4 °C for microbial analysis. While sampling the soil, it is crucial to consider the weather conditions as the presence of precipitation can impact and alter the results. This is of particular importance due to the designated points being water flow channels. It is recommended to take into consideration the weather conditions during the sample collection. The samples from all locations should be collected during similar weather conditions, ideally within short time intervals, noting the presence of rain in the days before sampling.

Soil analysis

At the laboratory, the microbiological analysis of the soil samples collected involves determining the presence and scale of growth of benzene degrading microorganisms.

Following the research methods established by Breza-Boruta et al. (2016), ten grams of each soil sample are added to 90 ml of Ringer's solution and homogenized for 30 min. Furthermore, tenfold serial dilutions of the solutions are made (10^{-1} – 10^{-6}). The adequate choice of final dilution depends on the preliminary results and comparison of the given dilutions. The inoculations of the soil solutions prepared are distributed on benzene culture media.

To determine the presence of benzene degrading bacteria, the growth medium should consist of minimal medium plates with benzene (BHB), and a Luria Broth (LB) plate for control. The procedure of growing and identifying benzene degrading bacteria is described as proposed by Jordi Pelkmans in the syllabus of the course Microbes for Sustainability at Utrecht University (2021). Each sample, based on the location and depth, is cultured in the number of three BHB plates and one LB plate. With an inoculation loop, 0.1 ml of the soil homogenate is distributed on the plates with proper media. The plates are then incubated for 2 days at 25°C.

The resulting growth after 2 days of incubation should be compared between the rich non-selective LB Medium and the selective benzene based BHB medium. Following, the BHB plates are transported to the fumehood, and the colonies and agar are sprayed with a catechol sprayer. This is done lightly to prevent the dissolving of the colonies. The colonies that change their color to yellow are isolated with an inoculation loop. If multiple colonies display such color, the different phenotype should be considered and inoculated separately. Two chosen yellow colonies are inoculated and transferred onto two separate LB plates. The plates are incubated for 2 days at 25°C.

After the incubation, the plates should be examined and compared with regard to the scale of growth. The colonies can be classified based on growth and size and described as pinpoint, small, medium, or large colonies (see

LaboratoryInfo (2021) for reference). The general scale of growth on plates, the pigmentation, and the characteristics of the shape of the colonies are also compared between plates.

For gram identification, from each sampling location an adequate, rich colony should be picked using a yellow pipette tip and inoculated into a universal with 10 ml LB. The solution is incubated at 37 °C for 3 days. Following, a droplet of the solution is stained with crystal violet, iodine, 96% ethanol, and safranin and can be placed under a light microscope with oil immersion 1000x resolution. The resulting gram identification between Gram-positive (dark purple) and Gram-negative bacteria (pink) should be recorded for further analysis.

Special remarks about research design and interpreting the results

There are several special remarks that have to be taken into consideration when conducting the research protocol described above. If making your own medium plates, it is important to confirm the presence of adequate medium components by inoculating the BHB plates with a known ATCC bacterial benzene-degrading strain. An example of an adequate strain choice could be *Pseudomonas putida* strain F1 (ATCC 700007) (Abu Hamed et al., 2004). This is important because the growth patterns of *Pseudomonas putida* strain F1 on benzene are known, and therefore, if the medium selectively supports the growth of benzene-degrading bacteria, this can be observed.

When considering the growth of bacteria on the selective and non-selective mediums, different scenarios have to be considered. Lack of growth on the BHB medium could be a result of either too high benzene concentration on the medium or the absence of benzene-degrading bacteria. It is important to note that no growth does not necessarily indicate a negative result, as the absence of benzene-degrading bacteria may be an indication of an extremely

polluted environment. No growth on the LB medium, which serves as a control and should show high growth levels due to the presence of nutrients that non-selectively support the colonies, indicates issues with the soil sampling which results in the death of the bacteria, or issues with the medium. LB medium should always show growth due to its rich components. If there is no growth on both the BHB and LB plates, it is an indication of problems with the procedures and soil sampling, because as mentioned previously, the LB medium should always promote some growth.

Another special consideration needs to be considered when choosing colonies for analysis following the catechol spraying. According to Singh et al. (2014), the presence of catechol confirms the established pathway of benzene biodegradation. Following the spraying of the BHB plates with catechol, the colonies should show yellow coloration. The yellow colonies show enhanced degradation and should be favored for further analysis. Nevertheless, the lack of yellow after spraying the colonies does not indicate lack of benzene degradation and it is important to choose colonies for further experiments regardless.

Discussion and Research Prospects:

This paper proposes a comprehensive description of the potential research of taking the first steps to identify benzene pollution in the vicinity of the landfill in Aruba by examining benzene degrading bacteria in the soil. The Landfill in Aruba poses environmental and health hazards through being overfilled with waste that is periodically burned and has potential leachates into the environment. Benzene is a toxic compound that is likely to be released into the surrounding of the landfill and result in contaminating the soil, natural environment, and human agglomerations. Identification of the pollution is possible through investigating the presence and type of benzene degraders living in the vicinity. These organisms offer not only an indication of potentially dangerous levels of

the chemicals but also can promote further research into biodegrading said toxic compound through the process of bioremediation. Bioremediation offers a promising solution to the environmental and health challenges, however, it is important to note that bioremediation is not a one-size-fits-all solution and should be carefully tailored to the specific site and type of contamination.

Further research:

The study of benzene-degrading bacteria next to the landfill in Aruba provides valuable insights into the state of pollution in the environment and suggests the potential use of bioremediation to clean up benzene-contaminated environments. Further research should be conducted to complement these findings and explore additional aspects of benzene contamination. One potential extension of the laboratory analysis could be to conduct DNA isolation and genotyping of the benzene-degrading bacteria present in the soil samples. The results could be obtained through BLAST analysis and would allow researchers to identify the specific strains of bacteria responsible for benzene degradation and potentially characterize their metabolic pathways and other features. A detailed understanding of the specific bacterial strands present in soil can lead to further evaluation of the pollution. This extension could involve inoculating soil samples with bacterial strains known to degrade benzene and monitoring the degradation of the compound over time. By measuring the rate of benzene degradation and the growth of the bacterial population, it is possible to very specifically estimate the extent of benzene contamination in the soil and the potential for bioremediation.

Another possibility for further research could be detecting the presence of benzene in the environment through other research methods such as chemical assays. Methods such as portable gas chromatography and the photo ionization detector, have been developed for rapid determination of benzene levels (Zhou et al., 2013). Although costly, these

methods could be applied to the extension of the study due to their small size and design for outdoor fieldwork. The obtained results could not only enable numerical representation of the contamination but they could also be compared to the Soil Guideline Values (Environment Agency, n.d.) in order to evaluate the scale of the pollution with regards to safe limits. This would provide a more comprehensive understanding of the extent and nature of benzene contamination in the study area. Finally, given that benzene is also present in areas adjacent to petroleum stations (Chaudhary et al., 2023), it would be interesting to extend the study to the locations of the refinery to investigate whether similar benzene-degrading bacterial communities are present and active. This could provide important insights into the bioremediation potential of these environments and inform strategies for managing benzene contamination in these contexts.

Acknowledgements:

I would like to send the biggest words of appreciation and gratitude to all the people supporting me throughout this research process. I would like to thank Eric Mijts for being my constant support and inspiration, I would like to thank Margot Koster for being open to supervising my work. Patrick Wijchers has never lost trust in my work and has been the reasonable yet supportive voice throughout. I would like to thank Riemsdijk van den Berg and Melissa De Veer who supported this project through opening their lab space to my work, but also their minds in brainstorm sessions. Thank you Lynette Genadry for your enthusiasm and input into the field research trip, and thank you Carlos Rodriguez and the Academic Foundation at UA for connecting us. I am sending my biggest gratitude to Anthony Hagedoorn and the whole Tranquilo/Ragamuffin family for being my support when it was time to run/sail away from academics. Finally I would like to thank everyone in the UAUCU group for being great feedback givers, always eager to discuss and share ideas, but also simply great friends.

References:

- 297 Sports. (n.d.). Airsoft Speed QB. Retrieved April 1, 2023, from <https://www.facebook.com/297sports/posts/airsoft-speed-qb-the-rematchesaki-a-tuma-lugar-na-parkietenbos-paintball-field-u/1751924918337873/>
- Abu Hamed, T., Bayraktar, E., Mehmetoğlu, Ü., & Mehmetoğlu, T. (2004). The biodegradation of benzene, toluene and phenol in a two-phase system. *Biochemical Engineering Journal*, 19(2), 137–146. <https://doi.org/10.1016/j.bej.2003.12.008>
- Afolabi, O. O., Wali, E., Ihunda, E. C., Orji, M. C., Emelu, V. O., Bosco-Abiahu, L. C., Ogbuehi, N. C., Asomaku, S. O., & Wali, O. A. (2022). Potential environmental pollution and human health risk assessment due to leachate contamination of groundwater from anthropogenic impacted site. *Environmental Challenges*, 9, 100627. <https://doi.org/10.1016/j.envc.2022.100627>
- Anderson, T.-H. (2003). Microbial eco-physiological indicators to assess soil quality. *Agriculture, Ecosystems & Environment*, 98(1), 285–293. [https://doi.org/10.1016/S0167-8809\(03\)00088-4](https://doi.org/10.1016/S0167-8809(03)00088-4)
- Aruba. (n.d.). Bing Maps. Bing Maps. Retrieved March 30, 2023, from https://www.bing.com/maps?ty=18&q=Aruba&satid=id.sid%3Ab892cccb-4a26-2969-8f82-2cd11e899fcf&mb=12.623367%7E-70.063843%7E12.4111816%7E-69.865509&ppois=12.51759147644043_-69.96467590332031_Aruba_%7E&cp=12.510821%7E-69.985381&v=2&sV=1&FORM=SNAPST&lvl=12.8
- ATSDR. (n.d.). *Benzene | ToxFAQs™ | ATSDR*. Retrieved April 2, 2023, from <https://www.n.cdc.gov/TSP/ToxFAQs/ToxFAQsDetails.aspx?faqid=38&toxid=14>
- Breza-Boruta, B., Lemanowicz, J., & Bartkowiak, A. (2016). Variation in biological and physicochemical parameters of the soil affected by uncontrolled landfill sites. *Environmental Earth Sciences*, 75(3), 201. <https://doi.org/10.1007/s12665-015-4955-9>
- Chaudhary, D. K., Park, J.-H., Kim, P.-G., Ok, Y. S.,

- & Hong, Y. (2023). Enrichment cultivation of VOC-degrading bacteria using diffusion bioreactor and development of bacterial-immobilized biochar for VOC bioremediation. *Environmental Pollution*, 320, 121089. <https://doi.org/10.1016/j.envpol.2023.121089>
- Chen, L., Zhang, J., Dai, H., Hu, B. X., Tong, J., Gui, D., Zhang, X., & Xia, C. (2020). Comparison of the groundwater microbial community in a salt-freshwater mixing zone during the dry and wet seasons. *Journal of Environmental Management*, 271, 110969. <https://doi.org/10.1016/j.jenvman.2020.110969>
 - Community Guide Aruba. (n.d.). *Metabolic Foundation*. ORG.Aw. Retrieved March 30, 2023, from http://www.org.aw/index.php?id=org_profile&do=metabolic
 - D'Ugo, E., Bruno, M., Mukherjee, A., Chattopadhyay, D., Giuseppetti, R., De Pace, R., & Magurano, F. (2021). Characterization of microbial response to petroleum hydrocarbon contamination in a lacustrine ecosystem. *Environmental Science and Pollution Research*, 28(20), 26187–26196. <https://doi.org/10.1007/s11356-021-13885-8>
 - Environment Agency. (n.d.). Soil Guideline Values for benzene in soil. *Environment Agency*.
 - EPA. (n.d.). *Benzene CASRN 71-43-2 | IRIS | US EPA, ORD [Reports & Assessments]*. US EPA National Center for Environmental Protection. Retrieved April 2, 2023, from https://iris.epa.gov/ChemicalLanding/&substance_nmbr=276
 - Flanders, W. (2021, December 11). *Enhancement Of Contaminant Metabolism—Microbiology*. Flanders Health Blog. <http://www.flandershealth.us/microbiology/iii-enhancement-of-contaminant-metabolism.html>
 - Henriquez, S. (2023, April 4). NTR | Allergieën, longziekten, kanker, besmettingsgevaar; het gezondheidschandaal Parkietenbos dat niet wordt onderzocht | Knipselkrant Curacao. <https://knipselkrant-curacao.com/ntr-allergieen-longziekten-kanker-besmettingsgevaar-het-gezondheidschandaal-parkietenbos-dat-niet-wordt-onderzocht/>
 - Hou, D., Al-Tabbaa, A., O'Connor, D., Hu, Q., Zhu, Y.-G., Wang, L., Kirkwood, N., Ok, Y. S., Tsang, D. C. W., Bolan, N. S., & Rinklebe, J. (2023). Sustainable remediation and redevelopment of brownfield sites. *Nature Reviews Earth & Environment*, 1–16. <https://doi.org/10.1038/s43017-023-00404-1>
 - Jindrová, E., Chocová, M., Demnerová, K., & Brenner, V. (2002). Bacterial aerobic degradation of benzene, toluene, ethylbenzene and xylene. *Folia Microbiologica*, 47(2), 83–93. <https://doi.org/10.1007/BF02817664>
 - Kalwasińska, A., & Burkowska, A. (2013). Municipal landfill sites as sources of microorganisms potentially pathogenic to humans. *Environmental Science. Processes & Impacts*, 15(5), 1078–1086. <https://doi.org/10.1039/c3em30728j>
 - Kim, D., Kim, Y.-S., Kim, S.-K., Kim, S. W., Zylstra, G. J., Kim, Y. M., & Kim, E. (2002). Monocyclic Aromatic Hydrocarbon Degradation by *Rhodococcus* sp. Strain DK17. *Applied and Environmental Microbiology*, 68(7), 3270–3278. <https://doi.org/10.1128/AEM.68.7.3270-3278.2002>
 - LaboratoryInfo, E. (2021, January 8). *Colony Morphology of Various Bacteria—Laboratoryinfo.com*. <https://laboratoryinfo.com/colony-morphology-of-bacteria/>
 - Landfill Parkietenbos. (n.d.). *Google Maps*. Google Maps. Retrieved April 1, 2023, from <https://www.google.com/maps/@12.4893211,-70.0033428,900m/data=!3m1!1e3?hl=en-US>
 - Loosveld, R. D. (2018). Improper waste management and the increasing threat to the Aruban economy: An assessment of adverse effects of anthropogenic disturbances on the Parkietenbos mangroves of Aruba [Bachelor Thesis]. <https://studenttheses.uu.nl/handle/20.500.12932/31303>
 - Mallarino, A. (2001). Management Zones Soil Sampling: A Better Alternative to Grid and Soil Type Sampling?

- Proceedings of the Integrated Crop Management Conference.* https://www.academia.edu/63760446/Management_Zones_Soil_Sampling_A_Better_Alternative_to_Grid_and_Soil_Type_Sampling
- Margesin, R., Zimmerbauer, A., & Schinner, F. (2000). Monitoring of bioremediation by soil biological activities. *Chemosphere*, 40(4), 339–346. [https://doi.org/10.1016/S0045-6535\(99\)00218-0](https://doi.org/10.1016/S0045-6535(99)00218-0)
 - Mars, A. E., Kasberg, T., Kaschabek, S. R., van Agteren, M. H., Janssen, D. B., & Reineke, W. (1997). Microbial degradation of chloroaromatics: Use of the meta-cleavage pathway for mineralization of chlorobenzene. *Journal of Bacteriology*, 179(14), 4530–4537. <https://doi.org/10.1128/jb.179.14.4530-4537.1997>
 - Mathieu, L. (2022). Breathing Unevenly: Community response to Environmental Injustice. A case study of Aruba's Landfill and the Parkietenbos community. UAUCU.
 - Overheid, A. (2022, December 27). Landfill Parkietenbos closes [Webpagina]. https://www.government.aw/news/news_47033/item/landfill-parkietenbos-closes_61301.html
 - *Project Aruba*. (n.d.). Afvalzorg. Retrieved December 7, 2022, from <https://www.afvalzorg.com/about-us/projects/aruba>
 - Redactie. (2021, July 11). Bewoners zijn overlast landfill en verbrandingsoven Parkietenbos Aruba zat. Aruba.nu. <https://aruba.nu/2021/07/bewoners-zijn-overlast-landfill-en-verbrandingsoven-parkietenbos-aruba-zat/>
 - Riediker, S., Suter, M. J.-F., & Giger, W. (2000). Benzene- and naphthalenesulfonates in leachates and plumes of landfills. *Water Research*, 34(7), 2069–2079. [https://doi.org/10.1016/S0043-1354\(99\)00368-1](https://doi.org/10.1016/S0043-1354(99)00368-1)
 - Sambeek, M. H. G. van, Eggenkamp, H. G. M., & Vissers, M. J. M. (2000). The groundwater quality of Aruba, Bonaire and Curaçao: A hydrogeochemical study. *Netherlands Journal of Geosciences*, 79(4), 459–466. <https://doi.org/10.1017/S0016774600021958>
 - Sibeko, M. A., Adeniji, A. O., Okoh, O. O., & Hlangothi, S. P. (2020). Trends in the management of waste tyres and recent experimental approaches in the analysis of polycyclic aromatic hydrocarbons (PAHs) from rubber crumbs. *Environmental Science and Pollution Research*, 27(35), 43553–43568. <https://doi.org/10.1007/s11356-020-09703-2>
 - Singh, R., Singh, P., & Sharma, R. (2014). Microorganism as a tool of bioremediation technology for cleaning environment: A review. *Proceedings of the International Academy of Ecology and Environmental Sciences*, 4, 1–6.
 - *The Waste Management Virtual Platform*. (n.d.). Retrieved December 7, 2022, from <https://trashtocasharuba.org/>
 - Vogt, C., Kleinstaub, S., & Richnow, H.-H. (2011). Anaerobic benzene degradation by bacteria. *Microbial Biotechnology*, 4(6), 710–724. <https://doi.org/10.1111/j.1751-7915.2011.00260.x>
 - VY. (n.d.). *Parkietenbos Paintball Field, Oranjestad: Location, Map, About & More*. Retrieved April 1, 2023, from <https://vymaps.com/AW/Parkietenbos-Paintball-Field-51564/>
 - WHO. (n.d.). *Sustainable development*. Retrieved December 7, 2022, from <https://www.who.int/health-topics/sustainable-development>
 - Zeglin, L. H., Bottomley, P. J., Jumpponen, A., Rice, C. W., Arango, M., Lindsley, A., McGowan, A., Mfombep, P., & Myrold, D. D. (2013). Altered precipitation regime affects the function and composition of soil microbial communities on multiple time scales. *Ecology*, 94(10), 2334–2345. <https://doi.org/10.1890/12-2018.1>
 - Zhou, Y.-Y., Yu, J.-F., Yan, Z.-G., Zhang, C.-Y., Xie, Y.-B., Ma, L.-Q., Gu, Q.-B., & Li, F.-S. (2013). Application of portable gas chromatography-photo ionization detector combined with headspace sampling for field analysis of benzene, toluene, ethylbenzene, and xylene in soils. *Environmental Monitoring and Assessment*, 185(4), 3037–3048. <https://doi.org/10.1007/s10661-012-2771-1>



Jill van Bekhoven, University College Utrecht



Steff van den Berg, University College Utrecht



Julia Strijbosch, University College Utrecht



Zaïda Floren, University College Utrecht

Jill van Bekhoven, University College Utrecht

When I first heard about the Consultancy Project Aruba I immediately knew I had to apply. I was just looking at the requirements for Consultancy Project Utrecht when the course Consultancy Project Aruba caught my eye. I didn't hear anything about it yet, but it peaked my interest. Studying in the sunny Caribbean, while also experiencing everything Aruba has to offer? I love travelling and I also love to snorkel, so what is a better place to go to than Aruba? And on top of that, I always wanted to become a certified diver. This was a dream come true.

Although all these cool things are a nice bonus, I also knew this program would bring me a lot of academic opportunities. I thought this would be a unique learning experience, which would help me grow as an academic. But, most importantly, this time our research would really mean something to the Aruban community. During my studies I wrote many research papers, but those were just to learn something and gain experience. Now, our research would be meaningful, it would contribute to a better understanding of certain concepts and would help improve those. This became especially true when I heard we were going to research soil quality in farm lands. Almost no research was yet conducted on this, so our research would be groundbreaking. I hope our research will be the start of something big, namely many more enthusiastic researchers who will contribute to a better food system in Aruba.

During our research, I really learned to be flexible. Our first proposal focussed on agroforestry, but we had to completely change that. After we wrote a new proposal, new challenges arrived. We really wanted to research the Nitrogen, Potassium and Molybdenum supply and also the cation exchange capacity. We needed several materials for this, but unfortunately, it was a lot harder to get these materials to us than we first anticipated. In the end, we accepted the materials were not going to be here on time. We were disappointed, but we made the most of it. I believe

I immediately knew I had to apply.

that we still have a relevant research report and I hope other students can take our research over and finish what we started.

Not only did we conduct research in Aruba, we also made sure we had lots of fun. From swimming with turtles at Tres Trapi, making new friends, hiking at Arikok, admiring murals in San Nicolas, experiencing Aruban Carnaval, eating great food and exploring the underwater world to going to the beach as much as possible and enjoying the beautiful sunsets. I want to thank everyone involved for making this possible: Masha Danki!

Steff van den Berg, University College Utrecht

Aruba. A beautiful island surrounded by turquoise Caribbean waters, with pristine beaches, coral reefs, and a unique wildlife. A place I have the privilege of considering home. When I was informed that, for the first time ever, a group of students from my bachelor (Global Sustainability Science) would have the opportunity of conducting research in my home country of Aruba, I immediately signed up. Having lived in the Netherlands for nearly 3 years now, I saw this project as the perfect opportunity to apply my knowledge and research skills in practice on an island that I care for so deeply, and to give back to the community in a meaningful way.

Participating in the UA/UCU/UU research project of 2023 was a valuable learning experience for me, further preparing me for my future in the field of research. This project has given me the opportunity to further fully immerse myself in this field of sustainability, something I will always be grateful for. Not only have I further developed my sustainability vision, but I have also learned how complex and challenging conducting research can be. I have learned that proper planning is essential, that I have to be adaptable, collaborate with a large number of people, and accept failure as a valuable learning experience. Overall, this research project has been challenging, but also a rewarding experience that taught me these aforementioned valuable lessons.

I will also forever cherish the special and valuable moments I experienced with my peers, instructors, supervisors, and friends that I made along the way. I especially want to thank Eric for expanding my knowledge of the sustainability challenges and the wicked problems that small island states like Aruba are facing today. But most importantly, I would like to thank Eric for supporting me throughout the entire research project, both on an academic and personal level. I am not going to lie, these past few months were very challenging for me. Practically all of my lifelong friends from

A place I have the privilege of considering home.

Aruba and newer friends that I made in the Netherlands, are currently studying in the Netherlands. I am a very sociable person and I value my friendships very much; therefore at times it did feel lonely being here. Nevertheless, this also meant that I had a lot of alone time to reflect on my academic journey and what I want to do with the rest of my life. I now have a much better vision of what I find important in life and what career I would like to pursue. For that, I am forever grateful.

I would also like to thank my family for always supporting me in whatever I do. Without them, this whole journey would have been significantly more challenging. And dear Aruba, how I will miss you so dearly. Not only the beautiful beaches, coral reefs, and cacti forests, but especially all of the wonderful people that I have had the privilege of getting to know along the way.

Julia Strijbosch, University College Utrecht

'Let's all get a matching tattoo of the word 'palm tree' by the end of our stay!'- We joked in the first week of the program. Beautiful beaches and palm trees were indeed all around us but this island has so much more to offer. From deep conversations at the beach, to field work with farmers, walking around Oranjestad, and even Eric's depression tour (if you know you know), it was all just as impactful to me. Therefore, I would like to especially highlight two aspects of my stay, namely working together in a group and feeling like a professional in Aruba.

This year was the first time there was a group project in this research exchange program. I worked together with three other students from the Global Sustainability Science program in a consultancy project. It was an intense experience living together, working together and also spending most free time together. We went from total strangers to housemates, close friends, and colleagues all at the same time. This came with a unique set of challenges and opportunities. On the one hand, I realized that I love being around a group of people and having fun together all the time. Being together throughout this experience made it even more special, because we had people to share every little detail of our lives here with. On the other hand, having this intense group experience came with some emotional setbacks and made me highly value my alone time and independence. Being able to go anywhere and do anything I want whenever I want is a privilege I was taking for granted at home. Not having this made me more flexible in making plans together while at the same time feeling more appreciative of my independence.

When it comes to the project, one thing I did not expect when I got here, is how much the island would help me grow my confidence as a future professional. I never felt taken more seriously and capable than I have here in Aruba. Something about the environment, culture, and people, meant I could jump out of my comfort zone. I felt that

It came with a unique set of challenges and opportunities.

both the general public, our client, and teachers viewed our group as capable adults and respected us as such much more than I was used to. Santa Rosa (our consultancy client), for example, made us feel appreciated and like our research was really useful to them. I felt like what we were trying to accomplish could have practical impact, rather than simply being a theoretical idea for a course assignment. Because of that, I feel like we have started the transition from students to young professionals and I would like to thank everyone we have worked with for making us feel that way.

To conclude, even though I have decided that putting *'palm tree'* permanently on my body might not be the best idea, being in Aruba for the past few months still had a lasting impact on me and I could not be more grateful.

Zaïda Floren, University College Utrecht

On January 28th, a new chapter in my life began as I embarked on an 11-week consultancy project in Aruba. Alongside my friends Steff, Julia, and Jill, we were part of the first group of students from GSS to conduct the project on the island, rather than in the Netherlands. As I bid farewell to my loved ones at Schiphol Airport, a mixture of excitement and uncertainty filled my heart. Little did I know what awaited me in Aruba, but my yearning for sunshine had already taken hold.

Upon arriving in Aruba, I was greeted not only by the breathtaking weather but also by the warm and welcoming people. Our client, the Ministry of Agriculture, shared our enthusiasm for collaboration. It was heartening to witness the genuine interest and support we received from the locals. The farmers we interviewed during our project left an indelible impression on me. Their openness and eagerness to contribute to the farming community and the Ministry's goals were truly inspiring. Through their stories, I gained a deeper understanding of the unique challenges faced by those living on islands. While the world focuses on the vulnerability of islands to rising sea levels, the discussions often overlook the multitude of other hardships they encounter. Living on an island demands resilience and creativity in abundance.

Unfortunately, unforeseen circumstances cut my time on the island shorter than expected. Nonetheless, the experience taught me invaluable lessons about the importance of family and friends. I now firmly believe that the people we surround ourselves with greatly shape our lives. Aruba reminded me to seek out those who radiate love, provide unwavering support, and inspire personal growth. I became more appreciative of the blessings in my life: my loving family, supportive friends, and partner.

This exchange to Aruba not only broadened my perspective on culture and sustainability but also instilled in me a

Living on an island demands resilience and creativity in abundance.

profound sense of gratitude and the significance of personal connections. As I move forward, I carry with me the memories of the island's warm embrace and the resilience of its people.



Quantitative and Qualitative data on agricultural fields in Aruba

An interdisciplinary paper analyzing Aruba's agricultural soil quality and the relationships between local farmers and Santa Rosa

Introduction

Currently, the vast majority of all food products in Aruba are imported from the United States (59%) and the Netherlands (14%) (Sociaal Economische Raad, 2020). The island is highly reliant on other countries for its national food security. However, the cost of importing food products is high (Davila & Richard, 2018), leading to high food prices. While small island states are a diverse group of nations, most share such characteristics as limited land availability, insularity, susceptibility to natural disasters, and deep integration into global markets that make them particularly vulnerable to global environmental and economic change processes (Connell, 2020). This is also visible in Aruba. As climate change is one of those change processes, small island states are particularly vulnerable to the effects of climate change, and a resulting decrease in food security (Lenderking, 2021). Because of that, the island of Aruba has the incentive to increase the number of food products cultivated on the island itself (Sociaal Economische Raad, 2020). This can help diversify the economy and systematically strengthen national capacities to better manage risk and recovery from exogenous and endogenous shocks and enhance climate resilience (World bank, 2020).

One organization that is working towards more food security in Aruba through improving agriculture on the island is the Department of Agriculture, Livestock, Fisheries, and Farmers market of Aruba (DLVV), otherwise known as Santa Rosa. This

is a largely customer-focused governmental department that supports fisheries and agriculture (Santa Rosa - Information). In addition to these duties, DLVV is one of the responsible governmental administrations for managing and preserving the natural environment of Aruba on land and at sea. Research, project execution, information provision, and data collection in the primary sector are additional roles (Gobierno Aruba, n.d.). Furthermore, Santa Rosa is working with farmers on increasing the number of crops cultivated on the island. However, considerable knowledge gaps, especially with regards to agricultural-related topics, form a barrier to addressing challenges and concerns for local farmers. Of the current agricultural lands, little to no data is available on important agricultural indicators such as pesticide use, soil chemistry and nutrient supply, and management practices. Furthermore, according to the former director of Agriculture, Fishery & Husbandries (LVV) on Bonaire and consultant and inter-manager of tropical animal husbandry at Santa Rosa, little is known about farmers' current practices on the island of Aruba. This is the result of these farmers having invested large amounts of their own financial capital and energy in optimizing their practices. Rightfully, they are inclined to play their cards close to their chest, as to minimize competition among farmers on the island (E. Berben, personal communication, February 6, 2023).

We collaborated with Santa Rosa on a consultancy project with the main objective of gaining agricultural data in Aruba by interviewing farmers and analyzing soil samples. For this,

the following two main research questions will be the focus:

(1) *“To what extent are there differences in soil quality between traditional agricultural crop farms on Aruba?”*

Supported by the following sub-research questions:

- What water sources are used by Aruban farmers and (how) do they impact soil quality?
- What pesticides are used by Aruban farmers and (how) do they impact soil quality?
- What fertilizers are used by Aruban farmers and (how) do they impact soil quality?

(2) *“How do farmers perceive their relationship with Santa Rosa?”*

In order to gain an overview of the different water sources, pesticides, and fertilizers currently used by farmers, interviews will be conducted with farmers. By combining that information with data from soil quality measurements in the field, the different management practices (i.e., water source used, pesticide used, and fertilizer used) can be taken into account when comparing the soil quality of different agricultural plots and thus the sub-questions of the first main research question can be answered. Farmers might use different water sources, for example, groundwater reservoirs or - in special cases - effluent of treated wastewater. In the past few years, a pilot program has been running on Aruba, with Santa Rosa tapping effluent of treated wastewater at the wastewater treatment plant near Parkietenbos. The content of the wastewater, e.g., nitrogen levels and the presence of heavy metals, is not monitored daily (F. Flanegien, personal communication, February 15, 2023). If the effluent contains such substances, it might have influenced the soil quality of the agricultural plots at Santa Rosa (Ryan, Masri & Qadir, 2006). Moreover, the types of pesticides and herbicides used by Aruban farmers may influence the soil quality as well, by making the soil more acidic or basic, for example (Tripathi et al., 2020). Santa Rosa is also interested in how farmers perceive their relationship with the organization. With the increasing

importance of cultivating food on the island of Aruba, caused by the rise in fuel prices and concerns about the food quality of imported food products, it is important for Santa Rosa to provide farmers with the support and guidance they need. Therefore, in order to answer the second main research question and to gain general insights into the life of Aruban farmers and all the connected stakeholders in the field of agriculture, several questions regarding what it is like to be a farmer in Aruba and how Santa Rosa supports farmers will be asked to all farmers participating in this research project as well.

Methods

Study Area

The study areas of our quantitative soil analysis have been carefully chosen in agreement with our client, Santa Rosa. The first five plots available are located on the property of Santa Rosa, and therefore freely accessible for the research (*Figure 1*). Next to that, twelve additional agricultural sites spread out across the island were chosen with the collaboration and under the guidance of Ludwig Rasmijn, an employee of Santa Rosa.



Figure 1: Satellite image of the five agricultural plots of DLVV Santa Rosa (Source: Google Earth Engine)

Analytical framework

Figure 2 shown below presents the created analytical framework, which is the basis of the methods used in this research project. The framework can generally be divided into two categories: (1) quantitative and (2) qualitative. Soil chemistry (pH and EC) and soil texture are the focus of the

qualitative part of the paper. Semi-structured interviews will be the basis of the qualitative methods, where insights will be gained on the farmers' water sources, pesticide usage, fertilizer usage, and the relationship between Santa Rosa and the farmers. In the following sections, each part of this framework will be further explained.

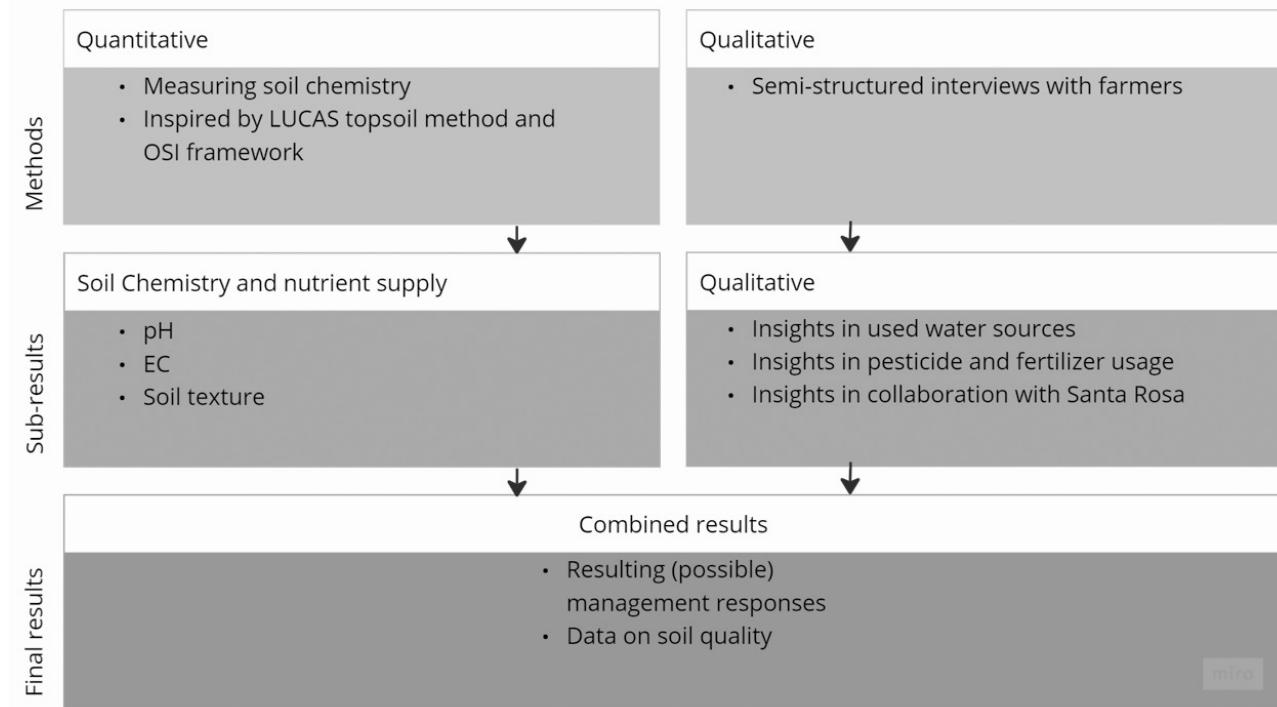

Figure 2: analytical framework combining the LUCAS topsoil method (Orgiazzi et al., 2018), OSI framework (Ros et al., 2022), and semi-structured interviews to investigate soil quality. In the end, this framework will result in possible management responses and data on soil quality in Aruba.

Qualitative data collection method

Qualitative information has been gathered in the form of semi-structured interviews. The topics touched upon in these interviews are: (1) what water source farmers use, (2) what pesticides farmers use (3) what fertilizers farmers use, and (4) how farmers perceive their relationship with Santa Rosa (see Figure 2). A full list of guiding questions can be seen in Appendix B1. The questions served as a guide; the order of the questions was not rigid and additional questions were occasionally asked promptly. Furthermore, departing from the guide was also not an issue, as long as there was an understanding gained at the end of the interviews concerning the relevant parameters in figure 2.

Furthermore, in order to ensure that a more complete narrative concerning the relationship between Aruban farmers and Santa Rosa can be presented, an interview with the current director of Santa Rosa, Ms. Nathalie Maduro, has also been conducted. Next to gaining insights on how the team of Santa Rosa perceives, amongst other things, their relationship with farmers, this interview was also specifically designed to gain a more comprehensive understanding of how this governmental department operates and collaborates with various stakeholders. The guiding questions that were created for this semi-structured interview can be seen in appendix B2. Finally, data on water sources, fertilizer use, and pesticide use of the aforementioned first five agricultural plots under the management and on the property of Santa Rosa has not been gathered in the form of interviews, but in the form of a datasheet that was shared with us by Santa Rosa's main consultant, Mr. Edward Berben.

Quantitative data collection method

Soil sampling: LUCAS topsoil methodology

For the quantitative soil analysis part, the "Land Use/

Cover Area frame statistical Survey Soil" (LUCAS) soil analysis method was used. The LUCAS is an extensive and regular topsoil survey that is carried out across the European Union to derive policy-relevant statistics on the effect of land management on soil characteristics" (Orgiazza, 2018). Following the LUCAS topsoil survey methodology, samples are collected from the designated locations by a process of composite sampling (Orgiazzi et al., 2018). For each agricultural plot, a random sampling point was chosen in the field. If this point was not considered suitable, due to e.g. slope, centrality in the plot, or proximity to external factors such as water sources, a second random measurement point was used. If that one also appeared not to be representative of the agricultural plot, the third random sampling point was used. This way, the sampling areas within agricultural plots are randomly selected, while ensuring the sampling points' representativeness of the whole plot. Five soil samples are taken at each agricultural site. The following principles are applied at the sampling location and are visualized in *Figure 3*:

- The soil sample must represent the area characterized by the LUCAS point.
- The central sub-sampling (C) location coincides with the LUCAS point.
- The other four sub-samples are collected at a distance of two meters from the central sub-sampling location in the shape of a cross. These points will be chosen based using a compass indicating where the magnetic north and south are. The sub-sampling points will then be labeled as the Northern (N), Eastern (E), Southern (S), and Western (W) sub-sampling points respectively. This label is a requirement for appropriately recognizing each sample in the lab. This is necessary for correctly identifying the points, which will be elaborated on in the data analysis section of this report.

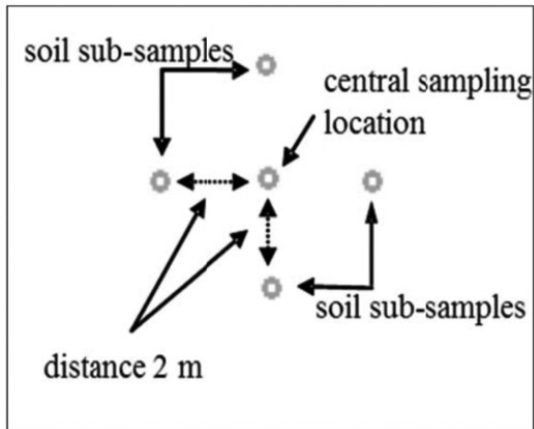

Figure 3: LUCAS topsoil sampling methodology

For all soil subsamples and the central sampling location, the coordinates of the samples were used to precisely determine the geographical locations of each point, which form the basis for giving the points a reference ID code for the data analysis, next to the North (N), East (E), South (S), and West (W) labels. Next to five samples in the agricultural plot, there are also five reference samples near the agricultural plots with the same method. These reference points, however, are on plots where the land use has not been changed from natural vegetation to agricultural land. That way, it is possible to compare the ‘natural’ situation near the plot with the agricultural plot. For these samples, a place was chosen as close to the agricultural plot as possible, which is accessible and not affected by irrigation or fertilizers.

The focus of this paper will be on the pH of the soil, which will be measured with the pH meter, and on the electric conductivity (EC) of the soil, which will be measured with an EC meter. Next to that, the soil texture will be determined with the jar method, which will be explained in the next section (*table 1*)

Soil chemistry and nutrient parameters	Method	Required measurement devices
pH	pH measurement	wtw pH 3310
EC	EC measurement	wtw Cond 3110
Soil texture	Jar method	Jars, ruler

Table 1: Parameters to determine soil quality

Determining Soil Texture

The soil texture is a very important factor because it relates to soil porosity, which contributes to the overall soil and plant health (Jeffers, 2019). The size of the pores—the space between the soil particles—is not only dependent on the soil type, but also on how the soil has been managed. Because of the intense biological activity and lack of human influence, soils with natural vegetation typically have high porosity. Soil porosity is important for the overall soil and plant health, because of water retainment, oxygen availability, and rooting. To determine the soil texture of the samples, the percentages of the three primary soil particles, sand, silt, and clay, need to be calculated. The Jar Test by Jeffers (2019) will be used to do this and is thoroughly explained in Appendix A1. This test enables us to calculate the percentages of clay, silt, and sand in each soil sample. After these percentages are calculated, the soil textural triangle (Figure 4) will be used to determine the soil texture (Jeffers, 2019)

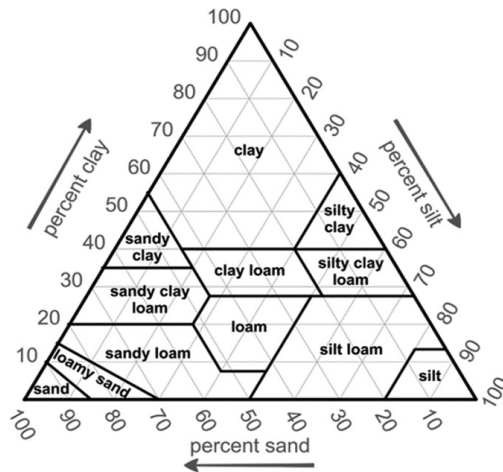

Figure 4: The Soil Texture Triangle (Jeffers, 2019)

Data analysis

Qualitative data

The aforementioned semi-structured interviews with the farmers and the director of Santa Rosa have been recorded using phone devices, with permission from the interviewees. Afterwards, transcripts were manually transcribed, as automatic transcription software as of today does not recognize the Papiamento language; while transcribing, the information was immediately translated into English. The transcripts of the interviews with the farmers have been analyzed using NVivo. Transcripts and notes were divided into five main categories: (1) water source, (2) pesticide use, (3) fertilizer use, (4) relationship with Santa Rosa, and (5) other. In the water source, pesticide, and fertilizer use categories, sub-categories were created based on the type of water and type of pesticide and fertilizer used. In category 4, about the relationship with Santa Rosa, the sub-categories followed the SWOT method: Strengths, Weaknesses, Opportunities, and Threats (KvK, n.d.). Comments of the farmers on the relationship will be assigned

into one of these four categories. In the 5th category, called 'other', sub-categories will be made based on the additional information given or questions asked by the farmers.

Quantitative data

Preferably, expected healthy ranges for these chemical parameters for the Aruban climate, which can be described as a tropical steppe, semiarid hot climatological climate (BSh in the Köppen classification system; Oduber, n.d.), would enable us to determine the state of the quality of the soil of the reference points. However, extensive literature reviews have shown incredibly broad ranges of soil quality parameters for the BSh climate, and therefore, it was decided to exclude this from this research project. Nevertheless, this knowledge gap does highlight the relevance of gathering data on soil quality parameters in regions with the BSh climate. The main aim of this section is to compare the soil quality of different agricultural plots. As there is no data available yet on the different soil or field properties, the prime focus is to collect as much data as possible to answer the research question to use in different research projects.

Because of that, it was decided to simply compare the pH and EC of the agricultural plots with those of the reference points. Each sample point is imported into SPSS and given a reference name based on the reference ID code created based on the coordinates. For each data point, the values of the parameters in Table 1 and the corresponding water source and pesticide use of the farm were inserted in columns. First, the average EC and pH values were calculated at each agricultural plot, along with their standard deviation. Then, a Mann-Whitney U test was conducted (as the parameters were not normally distributed) to determine if there are significant differences in pH and EC between the control group and the experimental group.

Afterwards, an appropriate statistical test was chosen to determine for each variable whether the EC and pH have a significant relationship with the variable. For the relationship between water source and pH, for example, first, tests for

normality and equal variance were conducted with the Shapiro-Wilk test and Levene's test. Because the data was normally distributed and there was no equal variance, the Kruskal-Wallis test and Dunn's post-hoc test were chosen. Another example is the relationship between water source and EC, where there was a normal distribution and equal variance. Because of that, One-way ANOVA was conducted. For fertilizers and pesticides, a similar process has been conducted and statistical tests have been conducted based on if there was equal variance and a normal distribution. In the end, it was also tested whether a combination of water source, fertilizer, and pesticides affect the pH and EC, using a Three-way ANOVA. An overview of the statistical tests chosen for all the variables can be seen in table 2 below. Furthermore, appendix E shows all statistical tests, including the results of the tests for normality and equal variance.

Nominal variable	Scale variable	Statistical test used
Water source	pH	Kruskall-Wallis and Dunn's post-hoc
	EC	One-way ANOVA and Tukey post-hoc
Fertilizers	pH	One-way ANOVA and Tukey post-hoc
	EC	One-way ANOVA and Tukey post-hoc
Pesticide use	pH	Independent T-test
	EC	Independent T-test
Combination of water source, fertilizers, and pesticide use	pH	Three-way ANOVA
	EC	Three-way ANOVA

Table 2: A table showing what statistical tests were used for the impact of water source, fertilizers, pesticide use, and a combination of all three on the pH and EC of the soil.

Results

Qualitative data results

Interviews with farmers

A total of 11 interviews were conducted with farmers of 12 different farms spread out across Aruba; one of the farmers managed two different farms. The data gathered during these interviews has been grouped into main categories, namely: (1) water source, (2) pesticide use, (3) fertilizer use, (4) relationship with Santa Rosa, and (5) other. Additionally, data from the datasheet shared with us by Santa Rosa regarding the water source, pesticide use, and fertilizer use of the five active agricultural plots on the land of Santa Rosa has also been included in the tables of the (qualitative and quantitative) results section of the paper. This leads to a total of 17 agricultural plots that are included in this paper. All the tables with the exact data derived from the interviews have been organized in tables, which can be seen in Appendix D.

As can be seen in figure 5 below and in table 6 in Appendix D1, a total of 9 different types of water sources have been identified across the 17 different agricultural plots, of which 7 are currently being used. The most widely used water source is tap water from WEB, which was used on 8 out of 17 plots (47,05%), followed by both RWZI water and Santa Rosa dam water; both were used on 5 out of 17 plots (29.4%). On 4 out of 17 plots private dam water was used (23.5%), followed by 3-stage effluent from pig breeding farm, laundromat water, and rainwater; all three of which were used on 2 out of 17 plots (11.76%). Furthermore, some farmers have used or were planning to use water from their private wells and AC water, however, currently none of the 17 plots used these water sources (table 6 in Appendix D1).

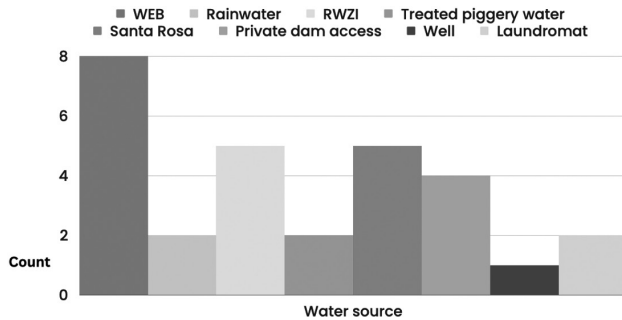

Figure 5: Water source uses amongst farmer interviewees

For the pesticide use on the 17 agricultural plots, 13 out of 17 (76,47%) did not use any type of pesticide. On a total of 4 plots (23.53%), some variety of pesticides are currently being used (figure 6). Pesticides used are unidentified fungicides and pesticides purchased by the farmers at Fantastic Gardens and Flora Market, the insecticide Vydate and the pesticide Lannate (table 7 in Appendix D2).

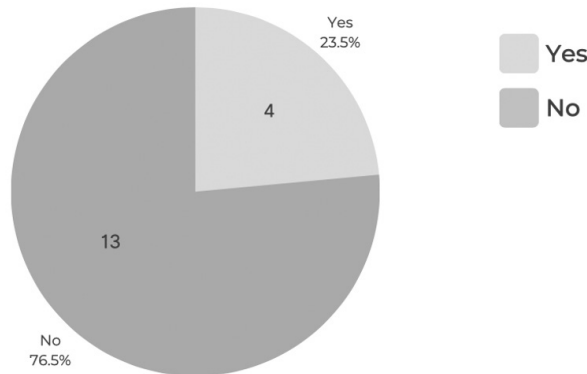

Figure 6: Pesticide use amongst farmer interviewees

In terms of fertilizer use on the 17 agricultural plots, there

was a wide range of different types being used. Of all the types of fertilizers, 5 main categories were created, namely: (1) Artificial store-bought fertilizers, (2) Biological store-bought fertilizers, (3) Animal-based compost, (4) Plant-based compost, and (5) Other. More often than not, multiple types of fertilizers were combined on a single plot. The most widely used was animal-based compost, used on 10 out of 17 plots (58.82%), followed by plant-based compost on 4 out of 17 plots (23.52%), artificial store-bought fertilizers on 3 out of 17 plots (17.65%), biological store-bought fertilizers on 2 out of 17 plots (11.76%), or ‘other’ types of fertilizers on 3 out of 17 plots (17.65%); (figure 7). The specific types of fertilizers within these categories are presented in table 8a in Appendix D3. Table 8b in Appendix D3 visualizes the different categories and sub-types of fertilizers used on each plot.

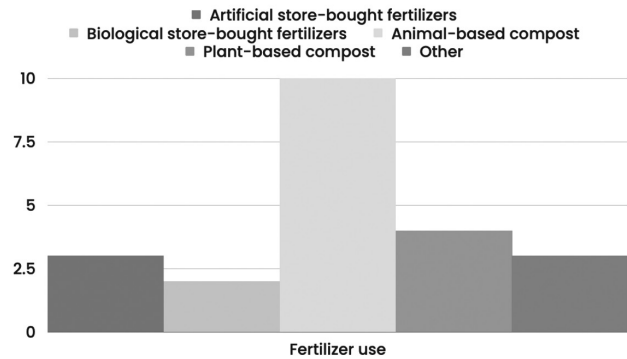

Figure 7: Fertilizer use amongst farmer interviewees

The relationship between the farmers and Santa Rosa, according to the farmers, can be grouped into three categories: (1) Positive, (2) Positive and negative, and (3) Negative; the second implying mixed feelings by the farmer. The majority of the interviewees (7 out of 12; 58.3%) had a predominantly positive relationship with Santa Rosa. The remaining 5 farmers (41.7%) had both positive and

negative relationships with Santa Rosa (figure 8 below; table 9 in Appendix D4).

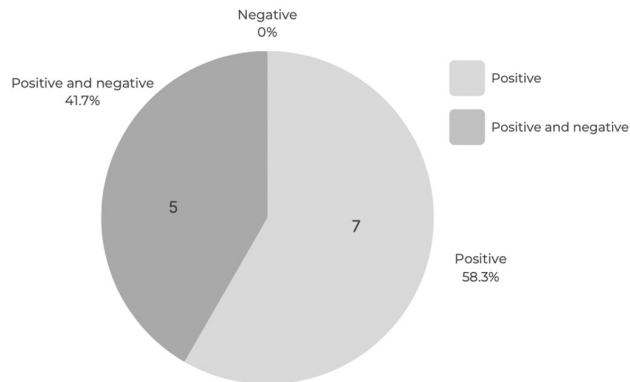

Figure 8: Relationship between farmers and Santa Rosa, according to the farmers.

SWOT framework

Based on the interviews with the farmers, the strengths of the SWOT framework can generally be summarized in three main categories. Firstly, the main strength of Santa Rosa, which was mentioned 12 times, was the physical services that Santa Rosa provides, which range from providing water (5), to clearing forested lands (4), to importing seeds from abroad (2), and lastly plowing soil (1). Next, another strength of Santa Rosa that was mentioned 2 times was offering farming tips/expertise. The last category of strengths that was created was the overall relationship between farmers and Santa Rosa, which was mentioned a total of 4 times. Three farmers referred to the relationship with one or more general employees of Santa Rosa, while one farmer specifically referred to the director of Santa Rosa. These strengths are visualized in figure 9 below, and the elaborated data can be found in table 10 in Appendix D5.

Weaknesses relating to the relationship between Santa Rosa and the farmers were identified as those things shared by farmers that have a direct or indirect negative influence on their trust in Santa Rosa, the functioning of Santa Rosa, or the quality of the services provided by Santa Rosa to farmers. Weaknesses were coded in NVivo following the codes: (1) Services and resources that Santa Rosa provides, (2) Farming knowledge/expertise, (3) Communication, (4) Bureaucracy, (5) Other. Most comments made by farmers were regarding the first code. Farmers identified a shortage of manpower and material for Santa Rosa to consistently provide certain types of services. Moreover, two farmers disclosed that they were wary of the tips given by the department, as they were advised to use harmful pesticides to support crop growth. Farmers feel like they are not able to consistently rely on Santa Rosa for support because of limited services and resources. Moreover, the perceived insufficiency of in-house knowledge harms the farmers' relationship with the department. Because of the long procedures within the department regarding requests for WEB meters and permits, some farmers decided not to apply for certain help altogether. The weaknesses are visualized in figure 9 below, and the elaborated data can be seen in table 11 in Appendix D5.

Opportunities relating to the relationship between Santa Rosa and the farmers can be grouped into the following categories: (1) Communication and contact with farmers, (2) Providing services/support to farmers, and (3) Other. Six comments made by farmers were regarding the first code, which were all suggestions for more interaction moments between the farmers and Santa Rosa and how to achieve that goal. Two farmers mentioned the potential for organizing annual or bi-annual general farmers conferences, and another farmer mentioned that Santa Rosa should orchestrate a national farmers' union. Next, five comments were made regarding the opportunity to enhance the services and support that Santa Rosa provides. Those ranged from physical support such as adding the service of well-drilling and expanding the service of cunucu (tropical dry forest) deforestation on already existing farms, to supporting farmers by adding more

experts to their team and creating more tutorials for farmers. The last category, coded as 'other', contained comments about collaborating with the Netherlands for better water provisions, converting Santa Rosa into a company, and creating an agricultural school for the youth of Aruba. The opportunities are visualized in figure 9 below, and the elaborated data can be seen in table 12 in Appendix D5.

Threats to Santa Rosa identified in the interviews can be grouped into the following categories: (1) Bureaucratic and governmental issues, (2) Individualism from farmers, (3) limitations in resources, (4) difficulties in collaborating, and (5) miscommunication. A total of four comments were made on bureaucratic and governmental issues. The comments were about favoritism within the organization of Santa Rosa, difficulties with red tape at DIP, lack of general governmental support, and resistance to changing outdated laws. Next, two comments

were about individualist behavior by farmers, due to the fear of repercussions if the government knew more about their farm and due to a bad relationship with Santa Rosa. Furthermore, two comments were made about the limitations in resources at Santa Rosa's disposal, which were specifically regarding the shortage of human capital at Santa Rosa and the limited agricultural equipment that Santa Rosa can offer. Moreover, two comments were regarding difficulties in collaboration: one about already-existing personal relations affecting the relationship between farmers and Santa Rosa employees, and other about general difficulty collaborating with different parties. Lastly, one comment was made regarding miscommunication, specifically about the spread of misinformation on Santa Rosa's rules. The threats are visualized in figure 9 below, and the elaborated data can be seen in table 13 in Appendix D5.

Figure 9: SWOT framework

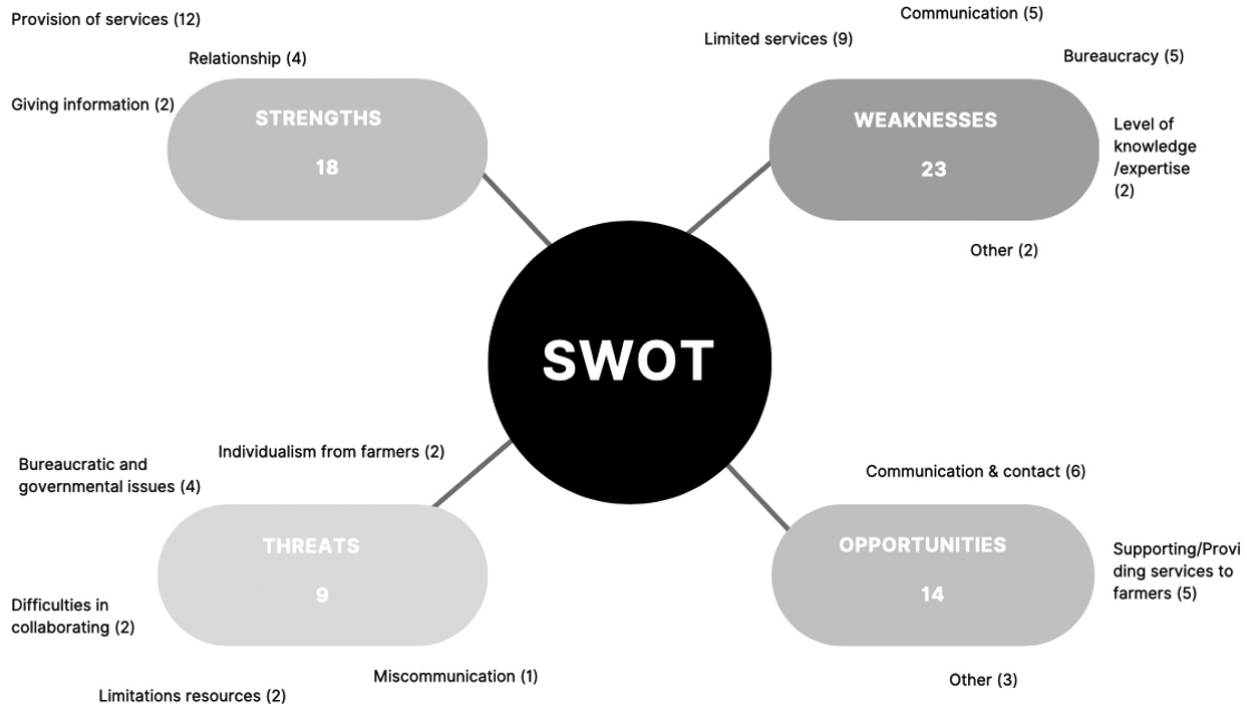

The analysis of the transcripts of the interviews with the farmers has also led to the creation of an overview of all the problems that farmers face, grouped into five different categories: (1) Problems dealing with Diseases/pests, (2) water problems, (3) high costs, (4) DIP problems, and (5) Other. The most prominent problem was the disease/pest problem, which ranges from unknown diseases and pests, fungi, bacteria, and insects. Three farmers mentioned that they currently did not seem to have an effective solution for their diseases/pests, and one farmer mentioned that their crops were highly sensitive to diseases and pests. Additionally, water problems were identified at 7 different farmers, which were about salty water, low nutrient content of WEB water, and high vulnerability when the dams dry out. Next, the problem of high costs was mentioned by 7 farmers, ranging from high fertilizer costs, high pesticide costs, and high WEB water costs. Having problems with DIP was mentioned 3 times, all three relating to the inability to properly register a property under the farmers' name. Lastly, two other problems were identified, namely, granite sand runoff from the road onto the farmers' plots and overall conflicting visions between all farmers on the island. All these problems are neatly categorized in table 14 in appendix D6.

Interviews with the director of Santa Rosa

The last qualitative results of this research derived from the interview with the director of Santa Rosa, Nathalie Maduro, the transcript of which can be seen in appendix D7. The main points of the interview are summarized in the following paragraphs.

The mission of Santa Rosa is to stimulate local production to reduce the island's dependency on the importation of foodstuffs from abroad in a clean way, by controlling the way food is produced, what water is used, and what chemicals are used; one of their goals is also to further minimize and eventually even get rid of the chemicals

(pesticides) that are still being used by farmers today. However, there seems to be a large number of obstacles in realizing this mission. Next to general limitations in the amount of arable land available, available local data, local agricultural experts, and low salaries, there is a mismatch between Santa Rosa's priorities and that of the politicians in power. This becomes apparent based on how the government perceives Santa Rosa and finances the department. According to Ms. Maduro, Santa Rosa is seen as a department where "dumb" people work. This seems to be a systemic problem, as both the result and cause of this image is the government hiring people without or with little formal education. Furthermore, there is no or little collaboration between the different departments of the governments and Santa Rosa, which adds to the problem of their image and realizing their mission, which inherently requires this collaboration between governmental departments.

In terms of the relationship between Santa Rosa and the farmers, the department is aware of the many critiques that the farmers have. With the hopes of gaining the trust of farmers and thus improving the relationship between them, Ms. Maduro has decided to not share the total list of active farmers on the island with the minister of agriculture. This was specifically done because farmers seem to be scared of tax repercussions if the government were to have information about their production.

Regarding the problems with DIP that were already established in this report, Ms. Maduro added that they are the result of an ongoing investigation into fraud and corruption of (former) DIP employees, which ultimately implies that all requests for properties on the island stagnated. Nevertheless, an agreement has been made with DIP that if a farmer does not have their registration in order, there should be more flexibility in the sense that they should still be able to make use of Santa Rosa's services.

Quantitative data results

EC and pH

Descriptive Statistics							
	N	Range	Minimum	Maximum	Mean	Std. Deviation	Variance
pH	170	3.769	4.411	8.180	6.95293	.654605	.429
EC	170	3763.48	16.52	3780.00	577.5960	516.23033	266493.758
Valid N (listwise)	170						

Table 3: Descriptive statistics of the EC and pH of all 17 agricultural plots showing the range, minimum, maximum, mean, and standard deviation of the pH and EC.

As shown in table 3 above, the average pH of all 17 plots and 170 sample points, including 5 reference points and 5 agricultural points at each location, is about 6.95. Within this, there is a range of 3.769 with a minimum value of 4.411 and a maximum of 8.180. The standard deviation is about 0.65 and there is a variance of 0.429. When it comes to the EC, there is a range of 3763, with a minimum of 16.52 and a maximum of 3780. The mean is about 577 microsiemens/cm, with a standard deviation of about 516 microsiemens. Besides that, there are also individual results for each plot (table 15 in appendix E).

Furthermore, it was tested if there is a significant difference between the experimental plots and reference plots. For pH, no significant difference was found between the control and experimental group; a Mann-Whitney U test indicated a p-value of 0.143406. For EC, there was also no significant difference between the control and experimental group, with a p-value = 0.170770 (see appendix F for all statistical tests in detail)

Soil structure

As is clear in the pie chart below, the jar test showed that loamy sand was seen at fifty percent of the plots; this soil

type generally consists of 70 to 85 percent sand, up to 30 percent silt, and up to 15 percent clay (Agriculture Victoria, 2020). Sand is represented in almost thirty percent of the plots and sandy loam is seen in twelve percent. Next to that, a few more soil texture types were only observed in one plot, namely, sandy loam, loam/silt loam, sandy clay loam/sandy loam, and silt loam.

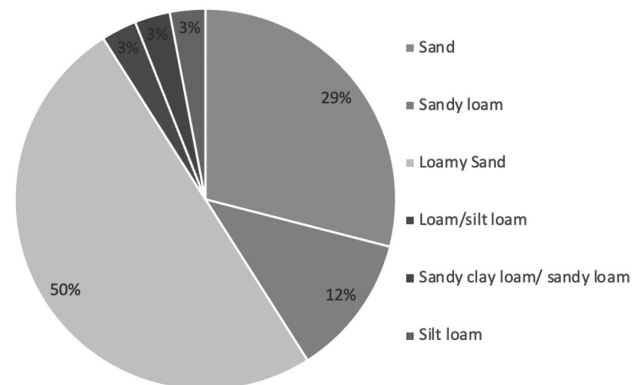

Figure 10: Pie chart showing the soil texture of the 17 reference plots and 17 agricultural plots

Water source, fertilizer, and pesticides influence

No significant correlations have been identified between the water sources, fertilizers, and pesticide use and the pH or EC (table 4). Moreover, when looking at the interaction effect of the three variables of water source, fertilizer use, and pesticide use, there was no significant correlation with the EC and pH. In appendix F, all statistical test results are available in more detail.

Table 4: Table showing the relationship of water sources, fertilizers, and pesticide use with the pH and EC of the soil with the p-values from the statistical tests of each parameter and the final result. Since all p-values are larger than 0.05, there are no significant relationships between any of the parameters.

Nominal variable	Scale variable	p-value	Result
Water source	pH	0.485415	No significant relationship
	EC	0.409400	No significant relationship
Fertilizers	pH	0.280496	No significant relationship
	EC	0.339378	No significant relationship
Pesticide use	pH	0.355568	No significant relationship
	EC	0.83694	No significant relationship

Combination of water source, fertilizers, and pesticide use	pH	Multiple values all larger than 0.05	No significant relationship
	EC	Multiple values all larger than 0.05	No significant relationship

Discussion

Qualitative data

Water sources

Across the 17 different agricultural plots, 9 different water sources were identified. The most commonly used water source is WEB water, which is water from the desalination plant on the island. WEB water is also more expensive than using rainwater or purchasing water from Santa Rosa. According to one of the farmers, even with the special prices for farmers as agreed upon with help from Santa Rosa, it is still the biggest cost for the farm.

With WEB water being referred to as “dead water” by one of the farmers, the usage of WEB water not only has a financial impact, but also an environmental one. As can be seen on the WEB website, its guidelines for water quality entail that the water contains very few Copper, Iron, Zinc, Phosphate, and Calcium, with some values being set even lower than WHO guidelines prescribe (WEB Aruba N.V., n.d.). One farmer specifically reflected on WEB water as adding no nutrients and additionally flushing away remaining nutrients in the soil as it seeps through to lower-lying areas. Additionally, the pH of the water is higher than normal rainwater. With the pH of clean rainwater being between 5 and 6, with neutral water having a pH of 7, the pH standards of WEB water ranges between 8.5 to 9.5. This indicates that WEB's water is alkaline (KNMK, n.d.; WEB Aruba N.V., n.d.). This might influence the pH of the agricultural soil in Aruba.

Last but not least, the desalination process is very energy-intensive, as the separation of salts and other solids from the seawater requires high levels of energy (U.S. Department of Energy, April 2019). The plant's energy is extracted from oil. With oil being a fossil fuel, the environmental impact of the plant's used energy is well-known. Moreover, research suggests that the plant also has a negative impact on the surrounding coral reef ecosystem's health and complexity, with higher rates of coral mortality and lower levels of live hard coral (Sundby, 2011).

The usage of the WEB water thus is more expensive than the other water sources available in Aruba and has negative environmental implications. However, the WEB water is also the only consistent water source on the island. With dams running dry outside of the rain season and Santa Rosa relying on rainwater for the water source they sometimes provide to farmers, WEB water is the farmers (un)holy grail. Unfortunately, it is not the only water source used by farmers that has serious benefits and even more serious consequences.

All plots at Santa Rosa, for example, are watered with water from the RWZI (Sewage Water Treatment Facility). The content of the wastewater, e.g. nitrogen levels and the presence of heavy metals, is not monitored on a regular basis (F. Flanegien, personal communication, February 15, 2023). If the effluent contains such substances, it might have influenced the soil quality of the agricultural plots at Santa Rosa (Ryan, Masri & Qadir, 2006). With the sewage treatment consisting of a process of settling, aeration, and UV filter cleansing, the RWZI irrigation water used by Santa Rosa is transparent, colorless, and odorless (F. Flanegien, personal communication, February 15, 2023). However, the clean look is deceptive. Only phosphorus content, nitrogen content, nitrate content, and phosphate content are measured when measuring material is available. In 2022, these materials were unfortunately largely out of stock. Therefore, data is missing on the nutrient content of

the water used by Santa Rosa. Additionally, the wastewater is not consistently monitored on bacteria such as *E. Coli* and Meningococcal (F. Flanegien, personal communication, February 15, 2023).

The effluent from the RWZI could pose as a reliable, consistent water source for farmers on the island. Given the island's arid nature, it might be a positive means of recycling precious water on the island. However, there are many unknowns on the impact of the use of the effluent on soil quality, and more importantly, on crop quality (Toze, S. 2006). The crops grown on the plots of Santa Rosa are not directly consumed by humans. However, they are fed to animals that are consumed by Arubans. Water quality issues and the exposure to contaminants such as human and animal pathogens are important drawbacks to the use of RWZI water (Toze, S. 2006). However, these points of concern can be controlled through treatment and effective management practices. To this date, these specific treatment requirements, measurement requirements, and management practices are not applied at the RWZI in Parkietenbos, nor at other RWZI installations; with limitations to available materials suggesting that the situation might not change any time soon (F. Flanegien, personal communication, February 15, 2023).

Another concerning water source is laundromat water. Two farmers currently use water from the laundromat, and two other farmers used to use it too. The farmers identified that the water helped because of the alive microorganisms, with their plants currently thriving. One of them does mix the water, as the laundry water contains a lot of soap. The method differs from the "greywater treatment" strategy employed in the U.S., as the water from the laundromat is not treated before it is disposed of on the agricultural plot (Eastern Funding, 2017). The water contains soap and organic nutrients, according to the farmers. However, as the water was not tested, this cannot be confirmed within this paper.

The water could pose microbial and chemical risks to public health (Mokhtari et al., 2012). According to Mokhtari et al. (2012), “Many excreta related diseases can be spread by wastewater use in agriculture to those working in the wastewater-irrigated fields and those consuming wastewater-irrigated foods, especially uncooked. However, the consumption of wastewater-irrigated foods is only one possible route of transmission, and this route may or may not be of local public health importance.” Cleaning detergents used in the laundromats contain chemicals that might lead to chronic respiratory problems, allergic reactions, and headaches. Moreover, the consumption of these cleaning detergents is highly advised against (American Lung Association, n.d.). What effect these detergents might have on soil and crop growth, is not completely known.

Farmers who use the laundromat water are excited about its availability and its effect on crop growth. With few water sources available against low costs, the attractiveness of using the laundromat water is only natural. Its environmental and health impact, however, might be worrisome. More research is needed to determine whether the use of untreated “greywater” is harmful to human health and the environment.

Pesticides and fertilizers

Farmers seemed to be generally aware of the negative impact artificial pesticides and fertilizers have on the environment. Only a small 25% of the plots looked at in this study were treated with some kind of pesticide, half of them bought at either Flora Market or Fantastic Gardens. On less than 20% of the plots, artificial fertilizers were used. Most plots were treated with self-made or bought animal compost, plant compost, or biological store-bought fertilizers. It seems that farmers prefer to make their own compost and prefer to know exactly what they use to treat their crops. None of the farmers still used 20-20, a highly concentrated plant fertilizer, which Santa Rosa was concerned about (E. Berben, personal communication, February 6, 2023). This

development seems positive, with the farmers using mostly organic or natural fertilizers instead.

Relationship between farmers and Santa Rosa

When analyzing the results of the qualitative data regarding the relationship between the farmers and Santa Rosa, there seems to be an understanding from both parties that considerable obstacles stand in the way of fully supporting one another and achieving the shared mission of increasing local food production on the island. Though the majority of the farmers that were interviewed seemed to be generally positive about their relationship with Santa Rosa, a considerable number of all interviewed farmers did seem to have either complaints or suggestions to improve Santa Rosa’s services to them, and thus their relationship with each other. Nevertheless, the majority of the farmers did not seem to be particularly frustrated with Santa Rosa specifically but rather with the shortage, or absence some would argue, of support that Santa Rosa and the entire agricultural sector receive from ministers and politicians. These low levels of support have seemed to create a distance and separation between farmers and the government, which has ultimately also resulted in numerous farmers showcasing very low levels of trust in the government and fear of repercussions if the government were to be informed of numbers regarding their production. Nevertheless, this distance and mistrust have led to many farmers making the active decision to rely on their own expertise, experience, and investments to create a well-functioning and resilient farm, which logically implies that many of the interviewed farmers demonstrated high levels of pride when talking about their farm.

Support and guidance from Santa Rosa to address and potentially solve the problems that farmers face, such as water problems, problems with pests/diseases, and bureaucratic issues, seems to be very much limited due to low levels of collaboration between governmental

departments, low levels of financing for the primary sector, and Santa Rosa being wrongly portrayed as a sector for unintelligent people. Despite these challenges, there does seem to be a higher level of trust between the farmers and Santa Rosa, which has been one of the goals of the current director; a goal that was achieved by assuring farmers that their information would not be shared with the minister of agriculture. This strategy seems to have worked effectively. However, one can argue that in the long run, this will not be a holistic and sustainable solution to the aforementioned problems between the primary sector and the government.

Quantitative data

EC and pH

As became clear in the results section, the average pH of the samples is 6.95, notably close to the neutral pH of 7. This result is within expectations, as pH increases with precipitation because of leaching. As Aruba is a semi-arid area, there is relatively little rain; the islands of Aruba, Curacao, and Bonaire have a semi-arid climate, with an annual precipitation of around 550 mm (Martis, 2002). This likely results in a relatively high soil pH compared to agricultural areas in temperate climates. The values of the pH have a relatively large range. One reason for this could be varying irrigation. At the same time, the standard deviation is rather small, meaning that most measurements were close to the average value.

For EC, on the other hand, a very large range and standard deviation has been observed. One reason could be faulty measurements or outliers. Some of the measurements were abnormally high, even with multiple repetitions of a measurement.

There were not any significant differences in pH and EC between the reference points and experimental points. This could be because the reference points that were chosen

are too close to the experimental points. Because of that, the reference points could still be affected by fertilizers, pesticides, and irrigation, impacting the pH and EC. On the other hand, it could also be the case that the agricultural land and the natural land around it are simply quite similar when it comes to the parameters that we were able to measure. More extensive research and a larger data set are needed to draw an informed conclusion.

Soil structure

When it comes to the soil structure, it was found that loamy sand was the most prominent soil type. Next to that, sand and sandy loam were most prevalent. Looking at the soil triangle (figure 4), mostly the left corner was represented, meaning that all soil had a small amount of clay, a large amount of silt, and a varying amount of sand, from about fifty to hundred percent. Based on the climate of Aruba and visual analysis of the soil during soil sampling, this result is within expectations.

The main limitation of the method is that it has accuracy concerns. The measurements were based on the naked eye and marker stripes, meaning a very accurate result is difficult, if not impossible, to achieve. However, within the purposes of this method, those inaccuracies are expected and thus do not necessarily invalidate the results.

The influence of fertilizers, pesticides and water source

No significant relationship has been found between fertilizers, pesticides, water sources and the pH or the EC of the soil. This did come as a surprise, as our hypothesis was that we did expect to see an influence of at least the water source on the pH and EC of the soil. The hypothesis was based on the consideration of the wide differences in the chemical compositions of all the identified water sources. For example, the EC, the pH, and the nutrient composition of WEB water and treated piggery water are vastly different from one another. Nevertheless, the hypothesized relationships are not significant might be due to several reasons.

Firstly, due to time constraints and resource availability, there was a limited number of sampling points. If more points were researched, it is possible that a significant relationship would be found. Secondly, there were very large variances in the data, which makes the chance of significant relationships lower, especially in combination with the limited sampling points. One reason for this could be the inefficiencies in the methods or measurement devices. Especially when it comes to the EC, there were very large variances in data, possibly due to the EC meter itself. It is also possible that there would have been a significant relationship with soil nutrients such as phosphorus and nitrogen, which unfortunately could not be investigated due to logistical reasons. The initial plan was to also conduct an analysis with a spectrometer for nutrients and heavy metals in the soil. Since this was not possible, this research project will serve as a basis for a follow-up research project for SISSTEM students, to ensure that farmers do ultimately gain the nutrient and pollution data that was spoken to them about.

Conclusion

To gain insights into the different water sources, pesticides, and fertilizers that Aruban farmers use, and to gain a comprehensive understanding of the relationship between Aruban farmers and Santa Rosa, a total of 12 semi-structured interviews were conducted; 11 with local farmers and 1 with the director of Santa Rosa. From the analysis of these interviews, several conclusions could be extrapolated.

The majority of farmers rely on WEB water and dam water for their water supply. Numerous challenges remain with the reliance on these water sources for their irrigation, namely, the high cost and low nutrient composition of WEB water, the increasing dam water salinity, and the long waiting times for dam water. Furthermore, the vast majority of farmers do not seem to use any form of pesticides, as they are very much aware of the environmental and health

impacts of pesticide usage. Additionally, most farmers use a circular method of fertilizing their agricultural lands, namely, by producing their own compost from either animal manure or dead plant material. Analyzing the impact these independent variables might have on the pH and EC of the taken soil samples, has resulted in concluding that there seems to not be a single significant relationship. There was no significant difference between the reference plots and experimental plots. Furthermore, no significant relationships were found between water source, pesticides, fertilizers and pH, EC. Besides that, due to logistical issues, the nutrient concentrations in the soil could not be analyzed, highlighting the relevance of performing research on this topic. Nevertheless, as there is little to no data on important chemical and biological soil quality parameters of agricultural lands in Aruba, the information on pH, EC, water sources, pesticides usage, and fertilizer usage that was found in this research project remains valuable and usable for farmers, Santa Rosa, and policymakers. This paper forms a basis for further research on agricultural lands in Aruba, to develop local agricultural knowledge, increasing local production, and thus improving food security on the island.

To conclude this research paper, Aruban farmers face a large variety of challenges, with the most prominent ones being water problems, problems with pests/diseases, and bureaucratic issues. Using all of the tools and resources at their disposal, Santa Rosa attempts but seemingly struggles to assist and support farmers with all these problems due to a deficit in available experts working at Santa Rosa and a shortage of available resources. Despite this, it appears both the farmers and Santa Rosa share a common understanding that the limited support that farmers receive is the result of an underfunded and underappreciated agrarian sector by the government.

References

- Agriculture Victoria. (2020, March 23). *Soil Texture*. VRO | Agriculture Victoria. https://vro.agriculture.vic.gov.au/dpi/vro/vrosite.nsf/pages/soilhealth_texture
- American Lung Association. (n.d.-b). *Cleaning Supplies and Household Chemicals*. <https://www.lung.org/clean-air/at-home/indoor-air-pollutants/cleaning-supplies-household-chem#:~:text=VOCs%20and%20other%20chemicals%20released,asthma%20and%20other%20respiratory%20illnesses>.
- Connell, J., Lowitt, K., Ville, A. S., & Hickey, G. M. (2020). Food Security and Sovereignty in Small Island Developing States: Contemporary Crises and Challenges. *Springer Singapore eBooks*, 1–23. https://doi.org/10.1007/978-981-13-8256-7_1
- Davila, I.C., Richard, A. (2018, June 29). Caribbean Basin Retail Foods: Opportunities Abound in Aruba's Retail Sector. USDA Foreign Agricultural Service. Accessed via: https://apps.fas.usda.gov/newgainapi/api/report/downloadreportbyfilename?filename=Retail%20Foods_Miami%20ATO_Caribbean%20Basin_6-29-2018.pdf
- De Sociaal Economische Raad. (2020, November). *Voedselzekerheid op Aruba*. Sociaal Economische Raad. <https://www.ser.aw/pages/voedselzekerheid-op-aruba-nov-2020/>
- Eastern Funding. (2017b, August 15). *Should you consider a laundry-to-landscape system?* <https://easternfunding.com/news-and-events/blog/laundromats-dry-cleaners/should-you-consider-a-laundry-to-landscape-system/>
- Gobierno Aruba. (n.d.). *Directie Landbouw, Veeteelt en Visserij en Markthallen* (DLVV). government.aw. Retrieved February 9, 2023, from https://www.government.aw/governance-administration/directie-landbouw-veeteelt-en-visserij-en-markthallen-dlrv_45734/
- Jeffers, A. (2019). SOIL TEXTURE ANALYSIS “THE JAR TEST”. In Clemson Cooperative Extension: Home & Garden Information Center.
- KvK. (n.d.). *How to do a SWOT analysis in 5 steps*. <https://www.kvk.nl/english/marketing/how-to-do-a-swot-analysis-in-5-steps/>
- Lenderking, H., Robinson, S., Carlson, G. (2021) Climate change and food security in Caribbean small island developing states: challenges and strategies, *International Journal of Sustainable Development & World Ecology*, 28:3, 238-245, DOI: 10.1080/13504509.2020.1804477
- Martis, A., van Oldenborgh, G.J. and Burgers, G. (2002), Predicting rainfall in the Dutch Caribbean—more than El Niño?. *Int. J. Climatol.*, 22: 1219-1234. <https://doi.org/10.1002/joc.779>
- Mokhtari, T., Bagheri, A., Alipour, M. J. (2012). Benefits and risks of wastewater use in agriculture. In: First International and Fourth National Congress on Recycling of Organic Waste in Agriculture, 26–27 April, Isfahan, Iran.
- Oduber, M. (n.d.-b). *Departamento Meteorologico Aruba - Climate Data*. 2011, [www.meteo.aw. http://www.meteo.aw/climate.php](http://www.meteo.aw/climate.php)
- Orgiazzi, A., Ballabio, C., Panagos, P., Jones, A. and Fernández-Ugalde, O. (2018), LUCAS Soil, the largest expandable soil dataset for Europe: a review. *Eur J Soil Sci*, 69: 140-153. <https://doi.org/10.1111/ejss.12499>
- Ros, G. H., Verweij, S. E., Janssen, S. J. C., De Haan, J., & Fujita, Y. (2022). An Open Soil Health Assessment Framework Facilitating Sustainable Soil Management. *Environmental Science & Technology*, 56(23), 17375–17384. <https://doi.org/10.1021/acs.est.2c04516>
- Ryan, J., Masri, S., & Qadir, M. (2006). Nutrient Monitoring of Sewage Water Irrigation: Impacts for Soil Quality and Crop Nutrition. *Communications in Soil Science and Plant Analysis*, 37(15–20), 2513–2521. <https://doi.org/10.1080/00103620600822960>
- Shaxson, T. F., Barber, R. G., & Food and Agriculture Organization of the United Nations.

- Soil, the largest expandable soil dataset for Europe: a review. *Eur J Soil Sci*, 69: 140-153. <https://doi.org/10.1111/ejss.12499>
- Soil Health Assessment Framework Facilitating Sustainable Soil Management. *Environmental Science & Technology*, 56(23), 17375–17384. <https://doi.org/10.1021/acs.est.2c04516>
- Sundby, C. (2011). The environmental impact of the reverse osmosis desalination plant on the immediately surrounding water and coral reef ecosystem in Bonaire, Dutch Caribbean. *Physis:Journal of Marine Science IX* (19), 57-63. Accessed via www.dcdb.nl.
- Toze, S. (2006). Reuse of effluent water—benefits and risks. *Agricultural water management*, 80(1-3), 147-159. <https://doi.org/10.1016/j.agwat.2005.07.010>
- Tripathi, S., Srivastava, P., Devi, R. S., & Bhadouria, R. (2020). Influence of synthetic fertilizers and pesticides on soil health and soil microbiology. *Agrochemicals Detection, Treatment and Remediation*, 25–54. <https://doi.org/10.1016/b978-0-08-103017-2.00002-7>
- U.S. Department of Energy, Office of Energy Efficiency & Renewable Energy. (April, 2019). 7 Desalination. *Powering the Blue Economy: Exploring Opportunities for Marine Renewable Energy in Maritime Markets*. Page 86-98. Accessed via <https://www.energy.gov/sites/default/files/2019/09/f66/73355-7.pdf>
- Van der Wal, A., De Lijster, E., & Dijkman, W. (2016). Ontwerp Label Duurzaam Bodembeheer. In CLM Onderzoek En Advies (No. 910). CLM *Onderzoek en Advies*. <https://edepot.wur.nl/401825>
- Velho, V. F., Mohedano, R. A., Filho, P. B., & Costa, R. H. (2012). The viability of treated piggery wastewater for reuse in agricultural irrigation. *International Journal of Recycling of Organic Waste in Agriculture*, 1, 1-9.
- WEB Aruba N.V. | Water- en Energiebedrijf Aruba N.V. (n.d.). <https://webaruba.com/production/your-drinking-water>
- World Bank. 2020. Building Aruba's Food Security during the COVID-19 Pandemic and Beyond. Washington, DC. © World Bank. <https://openknowledge.worldbank.org/handle/10986/38506> License: CC BY 3.0 IGO.”

Previous UAUCU Student Research Exchange Collected Papers 2022:

Milena Stoilova

Sustainable tourism in Aruba: a myth or reality?
A case study from the Bucuti & Tara Beach Resort

Klara Röhrs

Remembering the Coast: Assessing the coastline and coastal changes on Aruba
by using volunteered geographic information (VGI)

Carlotta M. Henning

Learning to play it by ear: Understanding barriers to public participation
in urban planning on Aruba

Karlijn van der Loo

If the Ship Stops Sailing: How can food sovereignty in Aruba be protected
in public policy and developed as a notion in international human rights law?

Lynn Smeets

Impacting the island's future: an insight into the effect of perceived efficacy
of young Arubans on their civic and political engagement in environmental action

Maro A. Savvides

Communicating the Geologic History of Aruba: Contextualizing Gold
and Incorporating Human Activity as a Geologic Force

**Previous UAUCU Student Research Exchange
Collected Papers 2022:**

Joao Wendrich Teixeira

Winds of change in Aruba: a Push For The Return of higher Biodiversity

Tracy van der Biezen

How citizen science can contribute to Aruba's SDG indicators: Creating a framework for meta-analysis

Endy Brooks

SIDS vertical farming: water- and energy assessment on Albion strawberry production in Aruba

Nigel de Cuba

The challenges of implementing circularity in the flow of waste tyres on Aruba

Alejandra Moreno

Food security perceived by Aruban households

Armand Kelly

Electrification of airside equipment at Aruba Airport Authority

Previous UAUCU Student Research Exchange Collected Papers 2022:

Rachel Nel

Fostering community stewardship: The role of sense of place in participation in environmental initiatives

Sophia Klaußner

Water = Water, right? Comparing wetlands on the island of Aruba to determine influences of wastewater effluents on the water quality of a wetland area

Laura Mathieu

Breathing Unevenly: Community Response to Environmental Injustice. A case study of Aruba's Landfill and the Parkietenbos community

Michel Frank

Citizen science, a tool to fill the plastic waste data gap in Aruba

Daniel Balutowski

Brown Tides: Assessing the Past, Present, & Future State of Sargassum in Aruba Through a Mixed Methods Approach

**Previous UAUCU Student Research Exchange
Collected Papers 2020:**

Keti Kapanadze

Beyond Opinion Polls: Multiple Voices of (non)sovereignty from Aruban People

Jairzinho Croes

Leadership and Good Governance in Public Organizations in Aruba

Charlotte Mehlhart

The Ocean Paradox: Values Held by Resource Users in Aruba's Fisheries

Mikayla Quijada

Treating education as a business

Michele Li

Adolescent Health Issues on Aruba: A Children's Rights-Based Approach

Hannah Mayr

The Condition of 'Illegality':

Deconstructing the 'Illegalization' of Undocumented Venezuelans on Aruba

**Previous UAUCU Student Research Exchange
Collected Papers 2019:**

Linde van de Graaf

Of People and Mangroves: illustrations of a social-ecological system.

Mirre Stevens

Off-road driving and the ecosystem: An analysis of the impacts on landscape functionality.

Harlee Richards

Is it for me or the money? Local Inclusion in Tourism Development in Aruba.

Gina Melis

Mapping the Health Services Responses to Child Maltreatment: The Aruban Case.

Amy Priscilla Richards

Social Crisis Plan Aruba 2018-2020: Stimulating and Hindering Factors.

**Previous UAUCU Student Research Exchange
Collected Papers 2019:**

Florentine Röell	131
Once a Thief, Always a Thief? Factors Helping or Hindering the Reintegration of Ex-Prisoners on Aruba.	
Tiffany Lateefah Stein	157
Early detection of visual disorders in children in Aruba and assurance of timely care and services: The approach of the MDT-VOV.	
Keyla Reeder	185
From dependent student to independent pupil: the developmental impact of the Academic Foundation Year on Aruban students.	
Nina Gribling	199
Sharing stories bou palo: the making of heritage in a Caribbean oil town.	
Nicolette Andreina Habibe	225
The import costs of fruits and vegetables on Aruba: mitigating the volatility of prices to ensure sustainable supply.	

**Previous UAUCU Student Research Exchange
Collected Papers 2018:**

Daniel van Heusden - UCU

Aruba's Sustainable Entrepreneurial Ecosystem:
Drivers and Barriers for Sustainable Entrepreneurship

Xavier Boekhoudt - UA

Policy for energy system innovation:
Multi-actor policy-making of the Aruba energy transition

Jay-Mar Gamarra - UA

Perceived economic impact of tourism

Luc Lips - UCU

Determinants of eco-innovation: *The Aruban Case*

Annemieke Drost - UCU

Coral Health and Citizen Science

Emmeline Long - UCU

The impacts of oil contamination on the mangrove ecosystems of Aruba

**Previous UAUCU Student Research Exchange
Collected Papers 2018:**

Fabian Timpen - UCU and Emma Beroske - UCU
The impact of illegal dumpsites on the environment

Stephanie Arango - UA
Improving the Recruitment Procedure at the Renaissance Resort & Casino

Nora Röders - UCU
Becoming Aruban?

Thais Franken - UA
Putting Culture and Creativity in the Heart of the Aruban Sustainable Development

Dirijini Piter - UA
A look into the strategies utilized by SMEs on Main Street during
the Oranjestad redevelopment program

**Previous UAUCU Student Research Exchange
Collected Papers 2017:**

Culture, language, media and psychology

Louisa Maxwell - UCU

Calypso and cultural commodification in Aruba

Yun Lee - UCU

A correlation between cultural identity and juvenile delinquency in Aruba

Tanya Kirchner - UA

Understanding the roots of parasuicide among the adolescence in Aruba:
associated risks and protective factors

Melany Lloclla - UA

Volunteerism: an approach to encouraging more volunteering in Aruba

Zita Ngizwenayo - UU

Adolescent perceptions on language and professional communication

Rachel Tromp - UA

Social media use on Aruba in the business perspective

**Previous UAUCU Student Research Exchange
Collected Papers 2017:**

Policy, law, environmental sciences and sustainability

Rotem Zilber - UCU

Assessment of endemic fauna in key biodiversity areas

Larisa Leeuwe - UA

Environmental law: national and international perspectives

Ben Bultrini - UCU

Community participation in solid waste management in Aruba

William Cruice - UCU

Entrepreneurial governance and sustainable development on Aruba:
a cultural political economy approach

Rodolfo Rodriguez - UA

The synergy between academia and industry: success factors towards a healthy partnership

Nayla Yarzagaray - UA

The importance of tax compliance among SME's in Aruba for business continuity

Previous UAUCU Student Research Exchange Collected Papers 2016:

Language and Culture

Anne Maamke Boonstra - UCU

The Performance of Gender & Sexuality During Carnival on Aruba

Maja Vasić - UU

The preferred language of instruction in the higher education in Aruba:
attitudinal, situational and motivational aspects

Fardau Bamberger - UU

The role of English in Aruba's linguistic landscape

Health and Care Development

Felishah Ponson - UA

The emotional impact on people with disabilities striving to be independent in Aruba

Dahariana Evertsz - UA

A situational Analysis of the relevant welfare services and social security programs
for the older population of Aruba: implications for policy

Nurianne Dhalía Arias - UA

Diabetes Management in a Changing Society

International Relations and Diplomacy

Ghislaine Nicolaas - UA

Economic Diplomacy in Sub-National Island Jurisdiction

Previous UAUCU Student Research Exchange Collected Papers 2016:

Labor and Productivity

Giancarla Lobbrecht - UA

Absenteeism in the Public Sector

Gianira Maduro - UA

Satisfaction of the 'Bezoldigingsregeling Ambtenaren'

Organizational Transitions and Sustainability

Mirjam Snitjer - UU

"The Sexiness of Sustainability"

Perspectives Towards Sustainability of Aruban Citizens

Anniek van Wezel - UU

The utility and waste management sector in the 2020 vision of Aruba

Lizanne Takke - UU

Aruba's sustainable transition: leadership used in an organizational transition towards sustainability from a management perspective

Jochem Pennekamp - UA

Does the Model Fit the Format?

A Re-contextualization of the Triple Helix Model(s) in a Small Island Setting

Previous UAUCU Undergraduate Student Research Exchange Collected Papers 2015:

Florianne Sollie - UCU

Language and Education in a Multilingual Society:

Text comprehension and language attitudes among Aruban high school students.

Sil Boedi Scholte - UCU

Who Plays What Role to Take the Stage?

The Governance of Staging Authenticity and Commodification of Cultural Heritage in Aruba.

Kimberly van Loon - UA

Perceptions of internal communication, as told by employees within the health care sector.

Geneida Geerman - UA

Internal communication of sustainable development within hotel sector.

Sharon Meijer - UA

Sustainable practices of Aruban SMEs and their influence on the economy.

**Previous UAUCU Undergraduate Student Research Exchange
Collected Papers 2015:**

Petra Zaal - UCU

Reduction of energy consumption at Aruban hotels.

Francis Malca - UA

Legal perspectives on Solid waste management in Aruba.

Rikkert Loosveld - UCU

Does the Parkietenbos landfill have boundaries?

A waste and ph-gradient assessment of Parkietenbos.

Tobia de Scisciolo - UCU

The Assessment of Aruba's Shoreline Pollution:

A Comparison between the South and the North coast.

Giovanni Jacobs - UA

Mapping Aruba's policy on beach care.

U A U C U

Student Research Exchange *Collected Papers 2023*

